

TASCAM

D01152320A

HS-2000

2-Channel Audio Recorder

OWNER'S MANUAL

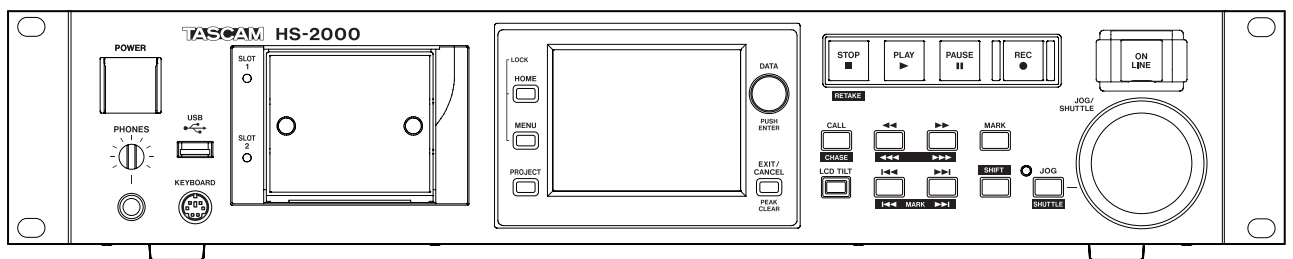

Important Safety Information



CAUTION: TO REDUCE THE RISK OF ELECTRIC SHOCK, DO NOT REMOVE COVER (OR BACK). NO USER-SERVICEABLE PARTS INSIDE. REFER SERVICING TO QUALIFIED SERVICE PERSONNEL.



The lightning flash with arrowhead symbol, within equilateral triangle, is intended to alert the user to the presence of uninsulated "dangerous voltage" within the product's enclosure that may be of sufficient magnitude to constitute a risk of electric shock to persons.



The exclamation point within an equilateral triangle is intended to alert the user to the presence of important operating and maintenance (servicing) instructions in the literature accompanying the appliance.

WARNING: TO PREVENT FIRE OR SHOCK HAZARD, DO NOT EXPOSE THIS APPLIANCE TO RAIN OR MOISTURE.

For U.S.A.

TO THE USER

This equipment has been tested and found to comply with the limits for a Class A digital device, pursuant to Part 15 of the FCC Rules. These limits are designed to provide reasonable protection against harmful interference when the equipment is operated in a commercial environment. This equipment generates, uses, and can radiate radio frequency energy and, if not installed and used in accordance with the instruction manual, may cause harmful interference to radio communications.

Operation of this equipment in a residential area is likely to cause harmful interference in which case the user will be required to correct the interference at his own expense.

CAUTION

Changes or modifications to this equipment not expressly approved by TEAC CORPORATION for compliance could void the user's authority to operate this equipment.

In North America use only on 120V supply.

This appliance has a serial number located on the rear panel. Please record the model number and serial number and retain them for your records.

Model number _____

Serial number _____

■ For European Customers

Disposal of electrical and electronic equipment

- (a) All electrical and electronic equipment should be disposed of separately from the municipal waste stream via collection facilities designated by the government or local authorities.
- (b) By disposing of electrical and electronic equipment correctly, you will help save valuable resources and prevent any potential negative effects on human health and the environment.
- (c) Improper disposal of waste electrical and electronic equipment can have serious effects on the environment and human health because of the presence of hazardous substances in the equipment.
- (d) The Waste Electrical and Electronic Equipment (WEEE) symbol, which shows a wheeled bin that has been crossed out, indicates that electrical and electronic equipment must be collected and disposed of separately from household waste.



- (e) Return and collection systems are available to end users. For more detailed information about the disposal of old electrical and electronic equipment, please contact your city office, waste disposal service or the shop where you purchased the equipment.

WARNING

This is a Class A product. In a domestic environment, this product may cause radio interference in which case the user may be required to take adequate measures

CE Marking Information

- a) Applicable electromagnetic environment: E4
- b) The average half-cycle r.m.s. inrush current
 - 1. On initial switch-on : 4.8A.rms
 - 2. After a supply interruption of 5s : 3.8A.rms

Safety Precautions

- 1 Read these instructions.
- 2 Keep these instructions.
- 3 Heed all warnings.
- 4 Follow all instructions.
- 5 Do not use this apparatus near water.
- 6 Clean only with dry cloth.
- 7 Do not block any ventilation openings. Install in accordance with the manufacturer's instructions.
- 8 Do not install near any heat sources such as radiators, heat registers, stoves, or other apparatus (including amplifiers) that produce heat.
- 9 Do not defeat the safety purpose of the polarized or grounding-type plug. A polarized plug has two blades with one wider than the other. A grounding type plug has two blades and a third grounding prong. The wide blade or the third prong are provided for your safety. If the provided plug does not fit into your outlet, consult an electrician for replacement of the obsolete outlet.
- 10 Protect the power cord from being walked on or pinched particularly at plugs, convenience receptacles, and the point where they exit from the apparatus.
- 11 Only use attachments/accessories specified by the manufacturer.
- 12 Use only with the cart, stand, tripod, bracket, or table specified by the manufacturer, or sold with the apparatus. When a cart is used, use caution when moving the cart/apparatus combination to avoid injury from tip-over.



- 13 Unplug this apparatus during lightning storms or when unused for long periods of time.
- 14 Refer all servicing to qualified service personnel. Servicing is required when the apparatus has been damaged in any way, such as power-supply cord or plug is damaged, liquid has been spilled or objects have fallen into the apparatus, the apparatus has been exposed to rain or moisture, does not operate normally, or has been dropped.

- The apparatus draws nominal non-operating power from the AC outlet with its POWER or STANDBY/ON switch not in the ON position.
- The mains plug is used as the disconnect device, the disconnect device shall remain readily operable.
- Caution should be taken when using earphones or headphones with the product because excessive sound pressure (volume) from earphones or headphones can cause hearing loss.
- If you are experiencing problems with this product, contact TEAC for a service referral. Do not use the product until it has been repaired.

CAUTION

- Do not expose this apparatus to drips or splashes.
- Do not place any objects filled with liquids, such as vases, on the apparatus.
- Do not install this apparatus in a confined space such as a book case or similar unit.
- The apparatus should be located close enough to the AC outlet so that you can easily grasp the power cord plug at any time.
- If the product uses batteries (including a battery pack or installed batteries), they should not be exposed to sunshine, fire or excessive heat.
- CAUTION for products that use replaceable lithium batteries: there is danger of explosion if a battery is replaced with an incorrect type of battery. Replace only with the same or equivalent type.

WARNING

- Products with Class I construction are equipped with a power supply cord that has a grounding plug. The cord of such a product must be plugged into an AC outlet that has a protective grounding connection.

■ RACK-MOUNTING THE UNIT

Use the supplied rack-mounting kit to mount the unit in a standard 19-inch rack, as shown below. Remove the feet of the unit before mounting.

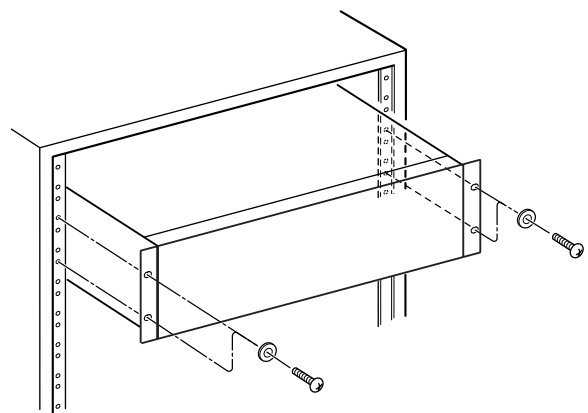

CAUTION

- Leave 1U of space above the unit for ventilation.
- Allow at least 10 cm (4 in) at the rear of the unit for ventilation.

Contents

1 – Introduction	7
Features	7
Included items	7
Manual conventions	7
Intellectual property rights	8
Precautions for placement and use.....	8
Beware of condensation.....	8
Cleaning the unit.....	8
Cleaning the display.....	8
About USB memory devices and CF cards.....	9
Precautions for use	9
Media that has been confirmed for use with this unit	9
Format.....	9
2 – Names and functions of parts.....	10
Front panel	10
Rear panel	13
PARALLEL connector.....	14
RS-232C connector	15
RS-422 connector.....	15
Home Screen	16
In timeline mode.....	16
In take or playlist mode	20
In on-air mode.....	22
3 – Preparations.....	24
Inserting and removing CF cards	24
Inserting CF cards	24
Removing CF cards	24
Security screws.....	25
About the display.....	25
Adjusting the display angle.....	25
Adjusting display and indicator brightness.....	25
Cautions related to display use	25
Turning the power ON and OFF.....	26
Setting the built-in clock.....	26
Lock function.....	27
Recording ties.....	28
4 – Basic operation	29
CF card preparation.....	29
Card selection.....	29
Formatting a CF card.....	30
Creating a project automatically after quick formatting.....	31
Creating a new project.....	31
Setting the master clock.....	32
Setting inputs and outputs	32
Setting the inputs	32
Setting reference levels.....	33
Connecting headphones.....	33
Using online functions	34
Recording operation limitations.....	34
5 – Projects	35
Project organization.....	35
File formats.....	35
Using the PROJECT screen	35
Project selection screen	35
Session selection screen	36
AES31 file selection screen	37
Take selection screen	37
Playlist selection screen	38
Project operations	38
Creating new projects	38
Editing project names	40
Changing project names later.....	40
Editing the name of the first session.....	41
Loading projects.....	41
Rebuilding projects	41
Deleting a project	42
Session operations	42
Creating new sessions.....	42
Loading sessions	43
Rebuilding sessions.....	43
Exporting sessions.....	44
Deleting sessions	45
Switching project screens.....	45
6 – Operation Modes	46
Timeline mode functions	46
Take mode functions	46
Playlist mode functions	47
On-air mode functions.....	47
Selecting the operation mode.....	47
7 – Timeline mode	48
Preparing to record	48
Basic preparations.....	48
Creating a new project.....	48
Creating new sessions.....	48
Recording mode settings.....	49
Setting the file format	49
Other recording settings	49
Making a recording	50
Locate to the recording start position	50
Recording.....	50
Stopping recording	50
Retaking a recording	50
Playback in timeline mode	50
Selecting a project and session.....	50
Setting input monitoring.....	51
Online function settings.....	51
Locate to the playback start position	51
Playback control in timeline mode	51
Using the call function	51
BWF-J cue point (timeline mode).....	51
Loading, saving and creating AES31 editing information	52
Loading AES31 editing information.....	52
Saving AES31 editing information.....	53
Naming and saving AES31 editing information.....	53
Creating new AES31 editing information.....	54
Importing all takes.....	55
Renaming AES31 file names.....	56
Deleting an AES31 file	57
Timeline editing.....	58
Selecting the range to copy/cut/delete.....	58
Setting the editing start (IN) point	59
Setting the editing end (OUT) point	59
Clearing the start and end (OUT) points	59
Selecting a complete region for editing.....	60

Copying the data of the selected area (Copy) ..60	ENTRY list screen84
Cutting the data in a selected area (Cut)61	ASSIGN file screen86
Erasing the data in the selected area (Erase)...61	Assigning a take to an entry.....87
Dividing regions at a specified position (Divide).62	Allocation of entries to pages.....87
Inserting copy buffer data at a set position (Insert)62	Clearing entry assignments.....88
Inserting a file at a set position (Insert File).....63	Editing entry names88
Inserting silence into a set area (Insert Mute)..64	Editing playback starting/ending points.....89
Pasting copy buffer data into the set position (Paste).....65	Setting playback to the BC\$STANDBY/END range90
Pasting a file at a set position (Paste File).....65	Editing the playback starting and ending points using the number buttons and mark list screen..91
Setting Fades for regions (Fade IN/FadeOut) ..66	Editing playback starting times92
Removing fades (Remove Fade IN/Remove FadeOut).....67	Editing lengths and levels of fade-ins/outs.....92
Setting the playback level of a region (Level)..67	Playback on ADJUST screens93
Undoing the previous edit (UNDO)68	Saving playlists.....94
Redoing an edit (REDO)68	Naming and saving playlists94
Bouncing.....69	Playback in playlist mode.....95
8 – Take mode70	Project, session and playlist selection95
Preparing to record70	Online function settings.....95
Basic preparations.....70	Playback control in playlist mode96
Creating a new project.....70	Using the call function96
Creating new sessions.....70	BWF-J cue point (playlist mode)96
Recording mode settings.....71	Using the flash start function96
Setting the file format71	10 – On-air mode.....97
Other recording settings71	Selecting files for playback.....97
Making a recording72	Playback area in on-air mode97
Recording.....72	Using the ON AIR button to switch between rehearsal/confirmation playback and broadcast playback modes.....98
Stopping recording72	Playback control in on-air mode.....98
Retaking a recording72	Credits playback98
Playback in timeline mode72	Using the call function99
Selecting a project, session and take.....72	BWF-J cue point (on-air mode).....99
Online function settings.....73	Changing the sampling frequency in on-air mode.....99
Setting input monitoring73	Limitations in on-air mode99
Playback control in take mode73	11 – Internal settings100
Using the call function73	Menu screen100
BWF-J cue point (take mode).....74	Recording settings (REC SETUP)100
Using the flash start function74	REC MODE page100
Take operations74	FILE FORMAT page101
Changing the start time of a take.....74	OPTIONS page101
Exporting takes75	Playback settings (PLAY SETUP).....102
Deleting a take.....76	GENERAL page (playback settings).....102
Sorting takes.....76	CONTROL page102
Reordering takes77	Sync and timecode settings (SYNC T/C)103
Editing take names77	CLOCK page103
Dividing takes.....78	SYNC page104
Combining takes79	T/C page105
Undoing the previous take edit.....80	SETUP page (Sync and timecode settings)105
Redoing a take edit.....80	I/O page106
9 – Playlist mode81	Remote settings (REMOTE SETUP).....106
Playlist operations.....81	GENERAL page (Remote settings).....106
Loading projects and sessions81	PARALLEL page107
Creating a new playlist82	RS-232C page107
Changing playlist names later82	RS-422 page108
Loading playlists83	ETHERNET page108
Deleting a playlist84	
Editing playlists (adding, removing and working with entries)84	

Contents

Audio Signal Input and Output settings (AUDIO I/O)	110	Selecting the flash page	130
INPUT page	110	Flash start playback	130
OUTPUT page	110	Standby playback (only with RC-HS32PD remotes)	131
Setting audio signal inputs and outputs (SETUP page).....	110	Operation using a computer keyboard.....	131
Level meter settings (METER SETUP)	111	Setting the keyboard type	131
System settings (SYSTEM SETUP)	112	Using a keyboard to input names	131
PREFERENCES page	112	List of keyboard operations.....	132
ANALOG Ref LVL ADJUST page	113	Network functions (FTP/telnet/VNC)	133
Backup/Startup page	113	FTP (file transfer protocol).....	133
CLOCK ADJUST page	114	Remote control by Telnet.....	134
Viewing system and firmware versions (VERSION INFO).....	115	VNC (virtual network computing).....	135
Viewing and using folders and files (BROWSE) ...	115	14 – Timecode synchronization	136
Viewing folders and files.....	115	Playback synchronized with timecode	136
Viewing folder and file information.....	116	Timeline mode	136
Copying a folder/file	117	Take mode	136
Deleting a folder/file	118	Playlist mode	136
Managing media (MEDIA MANAGE)	120	On-air mode.....	136
Selecting the operation mode (OPERATION MODE)	120	Recording synchronized with timecode.....	136
Folder structure	121	Timeline mode	136
File names	121	Take mode	136
12 – Mark and locate functions.....	122	Playlist mode	136
Mark functions	122	On-air mode.....	136
Adding marks	122	Basic operation with timeline synchronization... ..	137
Using keys to locate to marks	122	Timecode offset	137
Mark list screen	123	Rechase.....	137
Locating to marks.....	123	15 – Importing files recorded by other devices	138
Viewing mark information	123	Preparation before importing	138
Deleting marks.....	124	Using imported files on this unit.....	138
Editing mark positions	124	16 – Troubleshooting	139
Editing mark names	125	17 – Messages	140
Manual locate function	125	18 – Specifications	150
13 – Other functions	126	General.....	150
Confidence monitoring	126	Inputs and outputs	150
Mirror recording	126	Analog audio inputs and outputs	150
Online function.....	129	Digital audio inputs and outputs	151
Enabling the online function	129	Control inputs and outputs.....	151
Switching the online playback mode	129	Audio performance	152
Outputs during online playback	129	Other specifications	152
Flash start function	130	Dimensional drawings	152
Setting the flash key function.....	130	Block diagram.....	153

■ For China

产品有毒有害物质或元素的名称及含量

机种: HS-2000		有毒有害物质或元素					
	品名	铅 (Pb)	汞 (Hg)	镉 (Cd)	六价铬 (Cr (VI))	多溴联苯 (PBB)	多溴二苯醚 (PBDE)
1	CHASSIS部份	○	○	○	○	○	○
2	PCB Assy部份	×	○	○	○	○	○
3	线材部份	○	○	○	○	○	○
4	附属品部份	○	○	○	○	○	○
5	LABEL部份	○	○	○	○	○	○
6	包装部份	○	○	○	○	○	○

○: 表示该有毒有害物质在该部件所有均质材料中的含量均在 SJ/T11363-2006 标准规定的限量要求以下。

×: 表示该有毒有害物质至少在该部件的某一均质材料中的含量超出 SJ/T11363-2006 标准规定的限量要求。

(针对现在代替技术困难的电子部品及合金中的铅)

Thank you very much for purchasing a TASCAM HS-2000 2-Channel Audio Recorder.

Please read this manual thoroughly before using the unit so that you understand correct operating procedures and can use its functions fully. We hope that you enjoy using this unit for many years.

Please keep this manual so that you can read it at any time. A digital copy of this manual can also be downloaded from our website (<http://tascam.com/>)

Features

- CompactFlash cards used as recording media (Ultra DMA compatible)
- Dual slots allow two cards to be loaded and used simultaneously in mirror recording mode
- Confidence monitoring allows the signal that is being recorded to be played back almost instantly
- 2-track recording possible at up to 192kHz, 24-bit resolution
- Four operation modes: timeline, take, playlist and on-air
- In timeline mode, linear recording and playback possible (similar to a tape recorder)
- In take mode, playback and flash start of takes possible
- In playlist mode, takes can be added to a list and played back or activated using flash start in list order
- In on-air mode, the root folder files can be on-air playback.
- ON LINE key can be used for on-line playback and monitoring playback
- Broadcast Wave (BWF) and Waveform Audio (WAV) file formats supported
- Flash starting is possible using a TASCAM RC-HS32PD, RC-HS20PD or RC-SS20 remote control (all sold separately)
- In addition to using the remote controllers that are sold separately, flash starting is also possible using PARALLEL control or a keyboard
- Auto cue, auto ready and incremental play functions
- AES31 editing information can be imported and exported in timeline mode
- Playlist mode supports JPPA flash start playlist file loading and writing
- JOG/SHUTTLE function
- Intuitive operation using TFT color touchscreen graphical interface
- XLR analog balanced inputs and outputs
- XLR AES/EBU digital inputs and outputs
- XLR analog balanced monitoring outputs
- Headphones output
- XLR timecode inputs and outputs
- BNC video reference (NTSC/PAL black burst and HDTV Tri-level signals) and word clock input/output/thru
- 48 kHz pull-up/pull-down operation supported
- Files can be copied to connected USB memory
- LAN (Gigabit Ethernet) enables file transmission and remote control over a network
- Parallel remote control supported
- RS-232C serial remote control supported
- RS-422 (9-pin serial protocol) serial remote control supported
- Rack mounting (2U) possible

Included items

This product includes the following items.

Take care when opening the package not to damage the items.

Keep the packaging materials for transportation in the future.

Please contact the store where you purchased this unit if any of these items are missing or have been damaged during transportation.

- Main unit x1
- Power cord x1
- Rack-mounting screw kit x1
- Security screws x3
- Warranty card x1
- Owner's manual (this manual) x1

Manual conventions

In this manual, we use the following conventions.

- Keys, connectors and other parts on the main unit and external devices are indicated like this: **MENU**
- Messages and controls that appear on the touchscreen display are shown like this: 
- "CompactFlash card" is abbreviated as "CF card."
- Additional information is provided as necessary as tips, notes and cautions.

TIP

These are tips about how to use the unit.

NOTE

These provide additional explanations and describe special cases.

CAUTION

Failure to follow these instructions could result in injury, damage to equipment or lost recording data, for example.

1 – Introduction

Intellectual property rights

- TASCAM is a trademark of TEAC Corporation, registered in the U.S. and other countries.
- CompactFlash is a US registered trademark of SanDisk Corporation.
- Other company names, product names and logos in this document are trademarks or registered trademarks of their respective owners.

Any DATA, including, but not limited to information, described herein are intended only as illustrations of such DATA and/or information and not as the specifications for such DATA and/or information. TEAC Corporation disclaims any warranty that any use of such DATA and/or information shall be free from infringement of any third party's intellectual property rights or other proprietary rights, and further, assumes no liability of whatsoever nature in the event of any such infringement, or arising from or connected with or related to the use of such DATA and/or information.

This product is designed to help you record and reproduce sound works to which you own the copyright, or where you have obtained permission from the copyright holder or the rightful licensor. Unless you own the copyright, or have obtained the appropriate permission from the copyright holder or the rightful licensor, your unauthorized recording, reproduction or distribution thereof may result in severe criminal penalties under copyright laws and international copyright treaties. If you are uncertain about your rights, contact your legal advisor. Under no circumstances will TEAC Corporation be responsible for the consequences of any illegal copying performed using the recorder.

Precautions for placement and use

- The guaranteed operating temperature range of this product is 5° - 35° C (41°- 95° F).
- Do not install in the following types of places. Doing so could degrade the sound quality and/or cause malfunctions.
 - Places with significant vibrations or that are otherwise unstable
 - Near windows or other places exposed to direct sunlight
 - Near heaters or other extremely hot places
 - Extremely cold places
 - Places with bad ventilation or high humidity
 - Dusty places
- Make sure that the unit is mounted in a level position for correct operation.
- In order to promote the emission of heat, do not place anything on top of this product.
- Do not place this product on top of a powered amplifier or other equipment that emits heat.

Beware of condensation

If the unit is moved from a cold to a warm place, or used immediately after a cold room has been heated or otherwise exposed to a sudden temperature change, condensation could occur. Should this happen, leave the unit for one or two hours before turning the unit on.

Cleaning the unit

Wipe the unit with a soft dry cloth to clean it. Do not use paint thinner, alcohol or other chemical agents. Doing so could damage the surface of the unit or cause fading.

Cleaning the display

Slightly wipe the display with a soft dry cloth that does not shed dust (e.g. a cleaning cloth). Avoid wiping with a stiff cloth or rubbing with force. Doing so could damage the surface of the LCD. Do not use thinner, manicure remover, alcohol or similar substances.

About USB memory devices and CF cards

This unit uses CF cards for recording and playback.

It uses USB memory devices for backing up DATA on CF cards and for saving files to CF cards.

A list of USB memory devices/CF cards that we have confirmed to work with this unit is provided on our website (<http://tascam.com/>).

Precautions for use

USB memory devices and CF cards are precision devices. To prevent damage to the memory devices or card, please observe the following cautions:

- Do not leave memory devices or cards in extremely hot or cold locations.
- Do not leave memory devices or cards in extremely damp locations.
- Do not allow memory devices or cards to become wet.
- Do not place any objects on top of memory devices or cards, or twist or bend them.
- Do not subject memory devices or cards to strong impacts.
- Do not insert or remove a USB memory device or CF card during recording, playback, DATA transfer or other operations which access them
- Be sure to use cases to protect the connectors of memory devices and cards when carrying them.

Media that has been confirmed for use with this unit

This unit not only uses CF cards for recording and playback, but also uses USB memory devices for backing up DATA on CF cards and for saving files to CF cards.

We recommend using genuine TASCAM CF cards, but use of other CF cards that are available commercially is possible.

Microdrives cannot be used with this unit.

The capacities and performance of your HS-2000 will vary based on the speed and capability of the CF cards used. Older and some cheaper CF cards use slower memory components and little internal buffering which may result in poor recording performance.

Older and some cheaper USB memory devices use slower memory components and little internal buffering which may result in requiring more time to read and write DATA.

A list of USB memory devices/CF cards that we have confirmed to work with this unit is provided on our website. Otherwise please consult TASCAM Customer Support Section. (<http://tascam.com/>).

Format

When formatting media storage device, perform formatting on this unit. Media formatted on this unit is optimized to improve recording performance on recording. If media is formatted on other device or PC, etc. are used, this unit may not work optimally.

2 – Names and functions of parts

Front panel

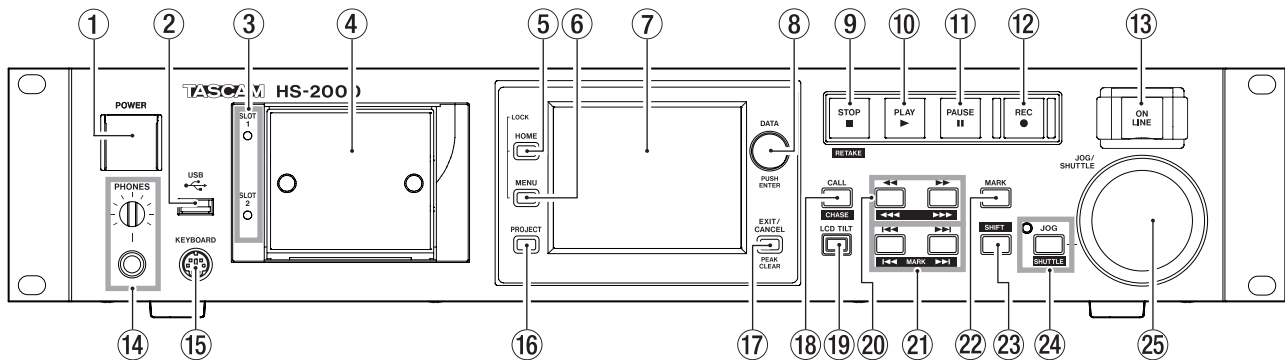

① POWER switch

Use to turn the power on and off. This switch has a cover to prevent accidental operation. Lift the cover from below to access and operate the switch.

② USB connector

By connecting a USB flash drive, for example, you can back up data from a CF card and transfer files from the drive to the card. (See "Viewing and using folders and files (BROWSE)" on page 115.) (See "Managing media (MEDIA MANAGE)" on page 120.)

Connect a USB keyboard to input the names of projects and sessions, for example. (See "Operation using a computer keyboard" on page 131.)

By default, the unit is set to use Japanese keyboards, which have a different layout from US English keyboards. To use a US English keyboard, change the setting on the PREFERENCES page of the SYSTEM SETUP screen. (See "PREFERENCES page" on page 112.)

NOTE

- Do not disconnect USB flash memory when transferring files. You can connect and disconnect USB flash memory at any other time.
- You can connect and disconnect USB keyboards at any other time.
- This unit is not compatible with devices other than USB flash drives and USB keyboards.

③ SLOT 1/SLOT 2 indicators

The indicator for the currently selected CF card slot lights. When recording or copying, it blinks rapidly. When no CF card is inserted in the current slot, it blinks slowly.

CAUTION

Do not remove a CF card from a slot when its indicator is blinking rapidly (because it is copying or recording).

④ CF card slots (SLOT 1/SLOT 2)

Insert CF cards here. (See "Inserting and removing CF cards" on page 24.)

⑤ HOME key

Press to open the Home Screen.

Press the **MENU** key while pressing and holding the **HOME** key to open the **LOCK SETUP** screen. (See "Lock function" on page 27.)

Turn the **DATA** dial while pressing and holding the **HOME** key to adjust the brightness of the color display, the **PAUSE**, **REC**, **PLAY** and **ON LINE** keys and the **JOG [SHUTTLE]**, **SLOT 1** and **SLOT 2** indicators.

Push and turn the **DATA** dial while pressing and holding the **HOME** key to adjust the brightness of only the color display.

⑥ MENU key

Press to open the MENU screen.

Press the **MENU** key while pressing and holding the **HOME** key to open the **LOCK SETUP** screen. (See "Lock function" on page 27.)

⑦ Color display

This 3.5-inch TFT touchscreen color display has a 320 x 240 resolution, and shows important information. It is also used to access and perform many operations.

⑧ DATA dial

Turn this to use as a **DATA** dial and press it to use it as an **ENTER** key. When setting parameter values, press while turning to change them in large increments (coarse mode).

When the Home Screen is open in take mode, if neither the number section on the **NEXT TAKE NAME** screen nor the Flash Page knob is selected, you can use this to select a take.

When a pop-up window is open, press this to use it as an **OK** or **CLOSE** button.

Turn the **DATA** dial while pressing and holding the **HOME** key to adjust the brightness of the color display, the **PAUSE**, **REC**, **PLAY** and **ON LINE** keys and the **JOG [SHUTTLE]**, **SLOT 1** and **SLOT 2** indicators.

Push and turn the **DATA** dial while pressing and holding the **HOME** key to adjust the brightness of only the color display.

⑨ STOP [RETAKE] key

Press to stop recording or playback.

Press this while pressing and holding the **SHIFT** key to retake the recording (erasing the last recorded take).

2 – Names and functions of parts

⑩ **PLAY key/indicator**

When stopped or in playback standby, press this key to start playback. This key lights during playback. Press this key when in recording standby to start recording.

In timeline mode, press the **PLAY** key while pressing and holding the **REC** key to start recording from that point.

The **PLAY** and **REC** keys both light during recording.

⑪ **PAUSE key/indicator**

Press this key while stopped or during playback to put the unit in playback standby. This key lights when in standby.

Press this key while recording to put the unit in recording standby. The **PAUSE** and **REC** keys both light when in recording standby.

⑫ **REC key/indicator**

When a recordable CF card is inserted and the unit is stopped, press this key to put the unit into recording standby. The **PAUSE** and **REC** keys both light during recording standby.

In timeline mode, press the **PLAY** key while pressing and holding the **REC** key to start recording from that point. The **PLAY** and **REC** keys both light during recording.

⑬ **ON LINE key/indicator**

Press to turn online playback mode on/off. The indicator lights when on and is unlit when off.

The switch has a cover to prevent accidental operation. Lift the cover from below to access and operate the switch. (See "Online function" on page 129.)

⑭ **PHONES knob/jack**

Connect stereo headphones to this standard stereo 1/4" phone jack, which outputs the monitoring signal. Use the **PHONES** knob to adjust the headphones output level.

CAUTION

Before connecting headphones, turn the **PHONES** knob to the minimum volume. Failure to do so could result in sudden loud noises, which might damage your hearing or equipment.

⑮ **KEYBOARD connector**

By connecting an IBM PC-compatible keyboard with a PS/2 interface, you can input the names of projects and sessions, for example.

By default, the unit is set to use Japanese keyboards, which have a different layout from US English keyboards. To use a US English keyboard, change the setting on the **PREFERENCES** page of the **SYSTEM SETUP** screen. (See "PREFERENCES page" on page 112.)

⑯ **PROJECT key**

Press to open the **PROJECT** screen that was used last (**PROJECT** selection, **SESSION** selection, **AES31** file selection, **TAKE** selection or **PLAYLIST** selection). (See "Using the **PROJECT** screen" on page 35.)

⑰ **EXIT/CANCEL [PEAK CLEAR] key**

Press to cancel input or item selection.

Press to close any open pull-up or pull-down menu.

On the Home Screen, when no pull-up/pull-down menu is open, press this key to reset the peak hold marks on the level meters

When the **MENU** screen or **PROJECT** screen is open, use this key to return to the Home Screen.

On other screens, use this key to return to the previous screen.

When a pop-up window is open, use this key to cancel the operation.

⑱ **CALL [CHASE] key**

Press to locate to and pause playback at the call point, which is where playback last started from playback standby.

Press this key while pressing and holding the **SHIFT** key to turn timecode synchronization on and off.

⑲ **LCD TILT button**

Press this button to unlock the color display, so that you can adjust its angle by pulling the bottom of the display outward.

To put the display away, press this button to unlock it and push the bottom of the display inward.

⑳ **◀◀ [◀◀◀] / ▶▶ [▶▶▶] keys (search)**

Press one of these keys to search.

◀◀ [◀◀◀] key: search backward

▶▶ [▶▶▶] key: search forward

Press one of these keys while pressing and holding the **SHIFT** key to search at high speed.

㉑ **◀◀ / ▶▶ [MARK ◀◀ / ▶▶] key (skip)**

Use these keys to skip between regions, takes and entries.

Press these keys while pressing and holding the **SHIFT** key to move between marks.

After moving, the unit returns to its previous playback state (stopped, playback standby or playback).

㉒ **MARK key**

Press this key to add a mark at the currently located time.

The maximum number of marks, including automatic marks, possible in a single timeline or take is 99. (See "Mark functions" on page 122.)

2 – Names and functions of parts

23 **SHIFT key**

When stopped, in playback standby or during playback, press and hold this key and:

- Press the **I◀◀** key to move to the previous mark, and resume the same playback state.
- Press the **▶▶I** key to move to the next mark, and resume the same playback state.
- Press the **◀◀ [◀◀◀]** key or **▶▶ [▶▶▶]** key to search at high speed.
- Press the **JOG [SHUTTLE]** key to activate the shuttle operation mode.
- Press the **STOP [RETAKE]** key to retake the recording (erasing the last recorded take).
- Press the **CALL [CHASE]** key to turn timecode synchronization ON/OFF.

24 **JOG [SHUTTLE] key/indicator**

Use to enable jog and shuttle dial operation.

Press this key to enable the jog operation mode of the **JOG/SHUTTLE** dial. When this mode is enabled, this indicator lights.

Press this key while pressing the **SHIFT** key to enable the shuttle operation mode of the **JOG/SHUTTLE** dial.

When this is enabled, this indicator blinks.

Press this key again to disable either mode.

25 **JOG/SHUTTLE dial**

When in jog operation mode, turn this to change the playback position by a corresponding amount.

When in shuttle operation mode, turn this to adjust the playback speed according to the degree of rotation.

In shuttle operation mode, returning to the original position restores the transport status to how it was before shuttle playback.

Rear panel

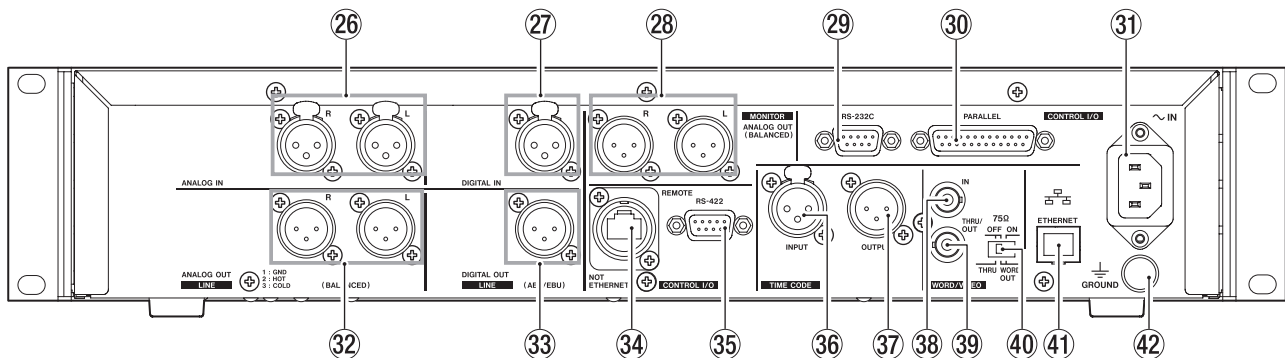

26 ANALOG IN [LINE] connectors (L/R)

These are balanced analog XLR connectors for line input. (1: GND, 2: HOT, 3: COLD)

27 DIGITAL IN [LINE] connector

This balanced XLR connector is for digital audio input in AES3-2003/IEC60958-4 (AES/EBU) or IEC60958-3 (S/PDIF) format.

Sampling frequencies of 88.2 and 96 kHz are transmitted at double speed. Sampling frequencies of 176.4 and 192 kHz are transmitted at quadruple speed. The built-in sampling rate converter can handle 32–192 kHz.

28 ANALOG OUT [MONITOR] connectors (L/R)

These balanced analog XLR connectors output the left and right monitoring signals. (1: GND, 2: HOT, 3: COLD)

29 RS-232C connector

Connect an external controller, for example, to this 9-pin D-sub connector for RS-232C serial control.

NOTE

It cannot be used at the same time as the **RS-422** connector. (See “RS-232C page” on page 107.)

30 PARALLEL connector

Connect a TASCAM RC-SS20 or other external controller to this 25-pin D-sub parallel control connector.

31 AC IN connector

Connect the included power cord here.

32 ANALOG OUT [LINE] connectors (L/R)

These balanced analog XLR connectors are for line output. (1: GND, 2: HOT, 3: COLD)

33 DIGITAL OUT [LINE] connector

This balanced XLR connector is for digital audio output in AES3-2003/IEC 60958-4 (AES/EBU) format. Sampling frequencies of 88.2 and 96 kHz are transmitted at double speed. Sampling frequencies of 176.4 and 192 kHz are transmitted at quadruple speed.

34 REMOTE connector

Connect a TASCAM RC-HS32PD or RC-HS20PD remote control (sold separately) here.

CAUTION

Never connect this to a network using an Ethernet cable. Doing so could damage this unit or network equipment.

35 RS-422 connector

Connect an external controller, for example, to this 9-pin D-sub connector for RS-422 serial control.

NOTE

It cannot be used at the same time as the **RS-232C** connector. (See “RS-422 page” on page 108.)

36 TIMECODE INPUT connector

This balanced XLR connector is for SMPTE timecode input.

37 TIMECODE OUTPUT connector

This balanced XLR connector is for SMPTE timecode output.

38 WORD/VIDEO IN connector

This BNC-type connector accepts a word clock signal (44.1kHz, 48kHz, 48kHz pull-down, 48kHz pull-up, 88.2kHz, 96kHz, 176.4kHz, 192kHz) or a video reference signal (NTSC/PAL black burst signal, HDTV Tri-Level signal).

Use the switch to turn the integral 75Ω terminator on or off.

39 WORD/VIDEO THRU/OUT connector [cut “WORD”]

This BNC-type connector outputs a word clock signal (44.1kHz, 48kHz, 48kHz pull-down, 48kHz pull-up, 88.2kHz, 96kHz, 176.4kHz, 192kHz or thru) or a video reference signal (IN connector signal thru only). Use the THRU/WORD OUT switch to set the signal output.

40 75Ω ON/OFF/THRU/WORD OUT switch

Use this three-way switch to make one of the following settings.

Terminator OFF and WORD/VIDEO THRU
Terminator OFF and WORD OUT (no VIDEO OUT)
Terminator ON and WORD OUT (no VIDEO OUT)

41 ETHERNET connector

Use this Ethernet connector to connect the unit with a network for file transfer and to control this unit from another device on the network.

2 – Names and functions of parts

42 GROUND terminal

When using a TASCAM RC-HS32PD or RC-HS20PD remote control (sold separately), depending on the operating environment, the color display might flicker or noise might be heard when monitoring. If this occurs, use the GROUND terminal to ground the unit. (No wire is provided for this use, so please prepare your own.)

PARALLEL connector

The **PARALLEL** connector on the rear panel allows external control of this unit.

You can also connect a TASCAM RC-SS20. (Connect to the RC-SS20's REMOTE 1 connector.)

The pin assignments are as follows.

Pin No.	Normal	TASCAM RC-SS20 PonMode	I/O
1	GND	GND	
2	PLAY	FLASH 1	I
3	STOP	FLASH 2	I
4	RECORD	FLASH 3	I
5	SKIP FWD	FLASH 4	I
6	SKIP BWD	FLASH 5	I
7	(Reserved)	STOP	I
8	FADER_START	FADER_START	I
9	TALLY_BC_STOP	TALLY_BC_STOP	O
10	TALLY_PAUSE/TALLY_BC_PAUSE	TALLY_PAUSE/TALLY_BC_PAUSE	O
11	TALLY_RECORD	RESERVED	O
12	TALLY_STOP	TALLY_STOP	O
13	TALLY_PLAY	TALLY_PLAY	O
14	REMOTE_SELECT, H or Open	REMOTE_SELECT, L	I
15	PAUSE	FLASH 6	I
16	(Reserved)	FLASH 7	I
17	AUX1, FF	FLASH 8	I
18	AUX2, REW	FLASH 9	I
19	AUX3, MARK	FLASH 10	I
20	(Reserved)	FLASH_PAGE	I
21	TALLY_BC_STANDBY	TALLY_BC_STANDBY	O
22	TALLY_CF1/TALLY_BC_CM	TALLY_CF1/TALLY_BC_CM*	O
23	TALLY_ONLINE	TALLY_ONLINE	O
24	TALLY_CF2/TALLY_BC_END	TALLY_CF2/TALLY_BC_END**	O
25	+5V***	+5V***	

I: Command input for transport control

Internal circuit, +5V pull-up

Operates with low commands of 50 msec or more

O: Command output, for tally output

The internal circuit is open collector (10Ω output impedance)

Outputs low commands when operating

20V maximum voltage, 35mA maximum current

*With an RC-SS20, assigned to the CF indicator

**With an RC-SS20, assigned to the CD indicator

***+5V: 50mA maximum supplied current

2 – Names and functions of parts

When REMOTE Select (pin 14) is set to high, it can be used as an ordinary parallel controller.

When set to low, flash start mode is enabled. In addition, depending on the Flash Page high/low setting (pin 20), the key assignments are as follows.

Pin 14	Pin 20	Flash start take
Low	High	1–10
Low	Low	11–20

TALLY_BC_*: Use menu setting to switch output (OFF, ON)

(When an RC-SS20 is connected set output to OFF.)

TALLY_BC_STOP/CM/END: 250msec pulse output

TALLY_BC_STANDBY/PAUSE: Level output

The following example is of a connection that uses a fader to start and stop playback of this device.

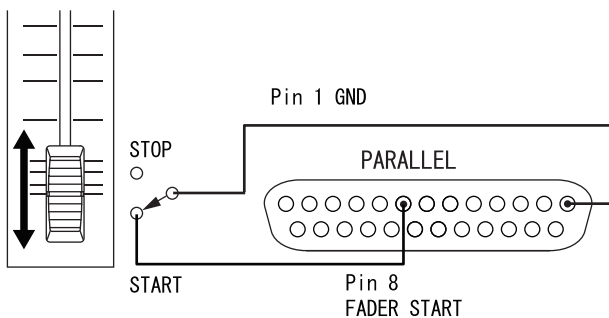

For information about the assignment of AUX 1–3 (pins 17–19) functions, see the “PARALLEL page” of “Remote settings (REMOTE SETUP)” on page 106.

NOTE

- When controlling this unit with an external device that is connected to the **PARALLEL** connector, by simultaneously inputting PLAY and RECORD signals while this unit is stopped, you can start recording immediately.
- In timeline mode, by simultaneously sending PLAY and RECORD signals during playback, you can start overwriting the recording.

RS-232C connector

The **RS-232C** connector on the rear panel can be connected to an **RS-232C** connector on a computer to allow control of this unit from that computer. Make settings related to communication on the **RS-232C** page of the REMOTE SETUP screen. (See “RS-232C page” on page 107.)

NOTE

Please contact TASCAM customer support for information about this unit’s RS-232C command protocol.

RS-422 connector

You can control this unit remotely by connecting the **RS-422** connector on its rear panel to a controller or editor compatible with the SONY P2 protocol (RS-422).

Use the REMOTE SETUP screen RS-422 page to make settings related to operation. (See “RS-422 page” on page 108.)

NOTE

Please contact TASCAM customer support for information about this unit’s protocol compatibility.

2 – Names and functions of parts

Home Screen

Press the **HOME** key to open the Home Screen.

In timeline mode

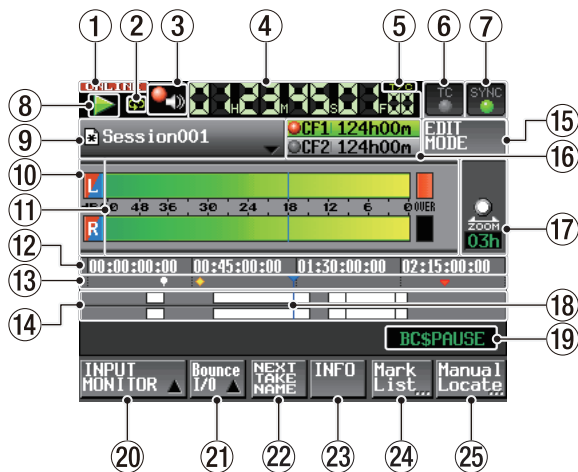

① ONLINE status indicator

When the online sending mode is ON, the red **ONLINE** icon appears.

When the online sending mode is ON, the **ONLINE** icon appears unlit.

② Repeat status indication

When repeat playback is ON, the green **Repeat** icon appears.

When repeat playback is OFF, the **Repeat** icon appears dimmed.

③ Confidence Monitoring status (button)

This icon shows the status of confidence monitoring.

Confidence monitoring enabled

Confidence monitoring disabled

Touch this button to open the “REC MODE” page of the REC SETUP screen where you can set confidence monitoring. (See “REC MODE page” on page 100.)

NOTE

This button only appears in timeline mode and take mode.

④ Time counter (button)

The time displayed is the elapsed time or the timecode time.

Touch the time counter to change the time display mode.

⑤ Time mode indicator (button)

This shows the current time display mode.

Touch the time counter to change the time display mode.



The time elapsed from the beginning of the timeline is shown.



The timecode for the timeline is shown.

⑥ Timecode status (button/indicator)



When accurate timecode is input and recognized correctly, the TC indicator appears green.



When timecode is not recognized correctly, the TC indicator appears dimmed.

The synchronized playback status is shown when playback is synchronized to timecode.



The **CHASE** indicator appears green when playback or recording is synchronized with external timecode or the internal timecode generator (selectable).



The **CHASE** indicator blinks if timecode synchronization is not being used and if not synchronized when timecode synchronization is being used.

Touch this area to open the SYNC T/C screen. (See “Sync and timecode settings (SYNC T/C)” on page 103.)

⑦ Audio synchronization status (button/indicator)



When synchronized to a master clock, the **SYNC** indicator appears green.



The **SYNC** indicator blinks when not synchronized to a master clock.

Touch this area to open the SYNC T/C screen. (See “Sync and timecode settings (SYNC T/C)” on page 103.)

⑧ Transport status indicator (button)

This icon shows the current transport status.



Playing back or jog playback (forward)



Jog playback (reverse)



Playback standby



Stopped



Searching backward



Searching forward



Searching backward (high-speed search)



Searching forward (high-speed search)



Number shown when searching backward (shuttle operation) reflects current speed: x2, x4, x8, x16, x32.



Number shown when searching forward (shuttle operation) reflects current speed: x2, x4, x8, x16, x32.



Recording



Recording standby

Touch this area to open the PLAY SETUP screen.

2 – Names and functions of parts

⑨ AES31 file name (button)

This shows the name of the currently loaded AES31 file (AES31 editing information file).

A "*" appears in the icon when the file has not been saved after timeline editing, a mark has been added or removed, or other changes have been made.

Touch this area to open a pull-down menu.



START TIME EDIT button

Opens the START TIME screen where you can set the timeline mode starting time.

This can only be selected when the transport is stopped.

REBUILD button

Rebuilds the additional index files for HS-2000 when files have been deleted or modified remotely using FTP, for example.

This can only be selected when the transport is stopped.

SAVE button

Saves the contents of the timeline.

This can only be selected when the transport is stopped.

(See "Saving AES31 editing information" on page 53.)

SAVE AS button

Allows you to rename and save the contents of the timeline.

This can only be selected when the transport is stopped.

(See "Naming and saving AES31 editing information" on page 53.)

CREATE AES31 button

Open the AES31 NAME screen to create a new AES31 file.

This can only be selected when the transport is stopped.

(See "Creating new AES31 editing information" on page 54.)

IMPORT ALL TAKES button

Use to import all takes in a session.

This can only be selected when the transport is stopped.

(See "Importing all takes" on page 55.)

⑩ Input monitoring indicators

The left ends of the level meters are input monitoring indicators. Their background colors depend on the input monitoring status, as shown below.

	Playlist mode	Timeline or take mode
MON OFF	L	L
MON ON	/	L

⑪ Level meters

When input monitoring is ON, the input signal level is shown when in recording standby or when recording. Each channel also has an overload indicator at its right end that appears red when the input signal reaches an overload level.

During playback, the playback level is shown if input monitoring is OFF.

When a digital input is selected as the source, but there is no input signal or if the actual input signal differs from the internal settings, the channel meter display area appears gray and one of the following messages appears.

Message	Meaning
D-IN NO SIGNAL	No input signal
D-IN UNLOCK	Input signal is not synchronized with the system
D-IN NOT AUDIO	Cbit information of the input signal is not audio
D-IN Cbit ERROR	Other input signal Cbit information differs from the actual operation mode



D-IN NO SIGNAL message

The following level meter display settings can be made on the METER SETUP page of the MENU screen.

- Metering point
- Peak hold time
- Release time
- Overload indicator peak level
- Reference level line display on/off

2 – Names and functions of parts

12 Time display area











The timeline is automatically divided into four equal divisions that show times according to the time display mode.

This area scrolls horizontally to correspond with the time counter.

13 Mark display area

Timeline marks appear here.

This area scrolls horizontally to correspond with the time counter.

-  BC\$CM mark
-  BC\$END mark
-  BC\$FILE mark
-  BC\$PAUSE mark
-  BC\$STANDBY mark
-  BC\$START mark
-  BC\$STOP mark
-  IN mark
-  OUT mark
-  Other types of marks

14 Track display area

The regions of each track are shown here, with the left track above and the right track below.

Region fade-ins, fade-outs and cross-fades are shown in light blue.

The following colors show the state of each region.

Ordinary state	White	
Recording	Orange	
Fade-in Fade-out Cross-fade area	Light blue	
Selected region	Medium blue	
Selected silence	Dark blue	

This area scrolls horizontally to correspond with the time counter.

15 EDIT MODE button

Touch this to enable and disable the edit mode, which allows you to divide, erase and cut parts of regions. (See “Timeline editing” on page 58.)



16 Recording media display (button)

This shows which CF card slot is currently in use and remaining recording times.

The background of the media that currently in use appears green during playback and red when recording.

If there is no media in the CF card slot, No Media appears on a light gray background.

If the CF card has no projects or sessions, No Project appears. When an unformatted CF card is inserted, UNFORMAT appears.

When a CF card is inserted in the slot that is not being used during recording, UNMOUNT appears. When recording stops, its remaining time will be shown again.

If the total number of entries, including files and subfolders, inside a session folder exceeds about 20,000, making recording impossible, Rec Limit is shown. For details, see “Recording operation limitations” on page 34.



Press this area to open the MEDIA SELECT screen. (See “Card selection” on page 29.)

Media status indicators

These indicators show whether or not a card can be used for recording, and is the selected media.

These appear in timeline and take modes, but not in playlist mode.

Indicator display

-  Recordable
-  Not recordable
-  Not selected

Examples of media remaining time buttons

① When REC MODE is set to Single

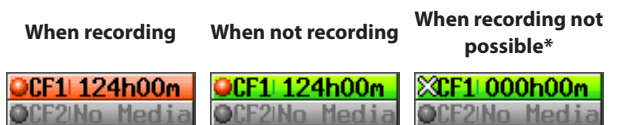

② When REC MODE is set to Mirror



③ When REC MODE is set to Mirror, but Mirror not enabled*

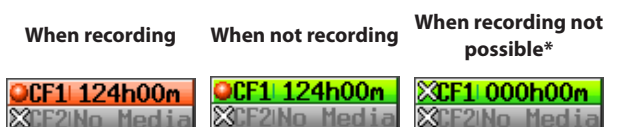

*For details about when recording is not possible and when Mirror is not enabled, see “Setting button appearance” on page 127.

2 – Names and functions of parts

17 Zoom setting

This shows the track area zoom level, which is the length of time displayed.

Turn the **DATA** dial right to zoom in (reduce the displayed area) and turn it left to zoom out (increase the displayed area).

18 Timeline cursor

This cursor shows the recording or playback position. It is always centered in the screen.

19 Mark name

This is the name of the mark at the current time or the nearest preceding mark.

Touch this when a mark name other than the auto mark is shown to open the mark name editing screen.

20 INPUT MONITOR button

Touch to open a pull-up with buttons to turn input monitoring ON/OFF.

When ON, the signal input through the input connectors is always output from this unit.

21 Bounce I/O button

Touch to open the Bounce pull-up menu.

Bounce button

Touch to bounce. In the following circumstances, it appears gray and cannot be used.

- When neither IN or OUT points have been set
- During playback or recording

SET IN button

Touch to set the current position as the bounce starting (IN) point.

SET OUT button

Touch to set the current position as the bounce ending (OUT) point.

CLEAR button

Touch to clear the currently set bounce starting (IN) and ending (OUT) points.

For details about the use of these buttons, see "Bouncing" on page 69.

22 NEXT TAKE NAME button

Touch to open the **NEXT TAKE NAME** screen where you can set the name that will be given to future recorded takes and files.

- First half of take names
The first half of the take name can be set to either the **User Word** or the **Session Name** (default).

CAUTION

The first half of the take name can only be changed when the unit is stopped.

- **User Word mode** (button)
Touch this to use the user word for the first half of the take name.
Press the **EDIT** button to open a screen where you can change the user word. (Operation is the same as the screen for editing project names.)



- **Session Name mode** (button)

Touch this to use the session name as the first half of the take name.



2 – Names and functions of parts

- Second half of take names

The second half of the take name is comprised of one letter and a three-digit number.

Press the **EDIT** button to open the screen where you can change the letter.

Change the three-digit number with the + and - buttons. You can also touch the numerical part to highlight (yellow) it and use the **DATA** dial to change the number.

In the following cases, “----” appears and the value cannot be changed.

- No project or session is loaded
- The selected card is unavailable
- The numerical part of the file name of the current take is 999

NOTE

- The Next Take Name setting is saved with each project. If you change projects, the setting of the loaded project will be used.
- The numerical part of the second half of the take name can be changed even during playback and recording. (The first half of the take name and the letter in the second half can only be changed when the transport is stopped.)
- A take can be created that has the same three-digit number in the second half as another take if the first half of their names or the letters in their second halves are different.

23 INFO button

Opens an information display that shows the current settings of the unit and the file name of the region currently below the timeline cursor.

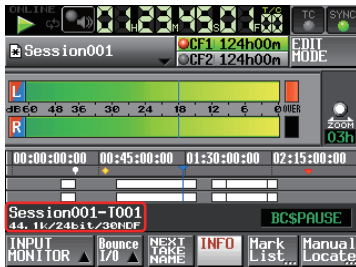

The upper line shows the file name of the region under the timeline cursor.

The lower line shows the current sampling frequency, bit length and frame type settings.

24 Mark List button

Opens the mark list. (See “Mark list screen” on page 123.).

25 Manual Locate button

Opens the **MANUAL LOCATE** screen. (See “Manual locate function” on page 125.)

In take or playlist mode

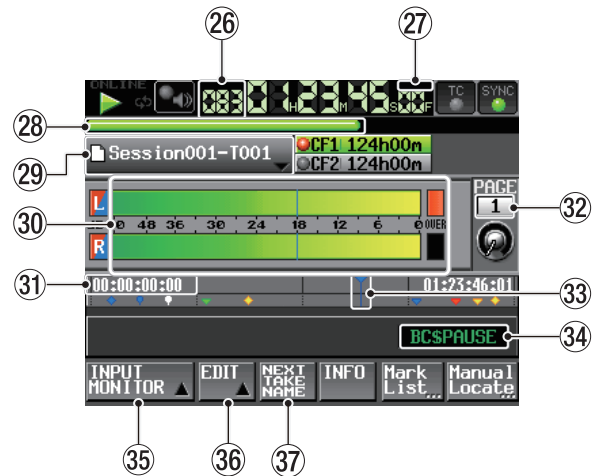

Take mode Home Screen

NOTE

In playlist mode, the **INPUT MONITOR**, **EDIT** and **NEXT TAKE NAME** buttons do not appear.

26 Take/entry number

The number of the currently selected take or entry is shown. When in recording standby, the file name that will be given to the next recorded take is shown. Takes are numbered in the order recorded within a session.

27 Time display mode (button)

This icon shows the current time display mode. Touch the time counter display to change the time display mode.

Mode	Meaning
ELAPSED	Elapsed time from the beginning of the take
REMAIN	<ul style="list-style-type: none"> • During playback, the time remaining until the end of the take • During recording, the time remaining until the maximum file size is reached
TOTAL	Elapsed time from the beginning of the session
T.REM	<ul style="list-style-type: none"> • During playback, the time remaining until the end of the session • During recording, the time remaining until the selected card will become full using the current recording settings
T/C	Timecode of the recording/playing file

2 – Names and functions of parts

28 Time bar

This shows the current playback position according to the time display mode.

Mode	Meaning	Bar display
	Current playback position relative to the length of the take or entry	Lengthens from left end to right end
REMAIN		Shortens from left end to right end
TOTAL	Current playback position relative to the length of all takes in the session or the entire playlist (white vertical lines appear at take and entry boundaries)	Lengthens from left end to right end
T.REM		Shortens from left end to right end
T/C		Lengthens from left end to right end

NOTE

During recording, a red progress bar lengthens from the left end to the right end approximately every five seconds.

29 Take/entry name display (button)

This shows the name and icon of the currently active take or entry.

During recording standby, the file name that will be given to the next recorded take is shown.

When in playlist mode, a "*" appears in the icon if the playlist has not been saved after editing (including the addition and removal of entries).

Touch to open a pull-down menu.

In take mode



TAKE List button

Opens the TAKE selection screen.

On the TAKE selection screen opened by this button, pressing a session folder name area does not open the SESSION selection screen. (See "Using the PROJECT screen" on page 35.)

CIRCLE @ TAKE button

Adds or removes "@" at the beginning of the current take name. (See "Take selection screen" on page 37.)

REBUILD button

Rebuilds the additional index files for HS-2000 when files have been deleted or modified outside the unit remotely using FTP, for example.

In playlist mode

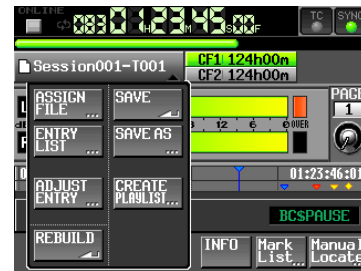

ASSIGN FILE button

Opens the ASSIGN screen where you can assign files. (See "ASSIGN File screen" on page 86.)

ENTRY LIST button

Opens the ENTRY list screen. (See "ENTRY list screen" on page 84.)

ADJUST ENTRY button

Opens the ADJUST ENTRY *** screen where you can edit entries. (See "Editing entry names" on page 88, "Editing playback starting/ending points" on page 89, "Editing playback starting times" on page 92 and "Editing lengths and levels of fade-ins/outs" on page 92.)

REBUILD button

Rebuilds the additional index files for HS-2000 when files have been deleted or modified outside the unit remotely using FTP, for example.

SAVE button

Saves the current playlist. This can only be selected when the transport is stopped. (See "Saving playlists" on page 94.)

SAVE AS button

Rename and save the current playlist. This can only be selected when the transport is stopped. (See "Naming and saving a playlist" on page 94.)

CREATE PLAYLIST button

Opens the PLAYLIST NAME screen where you can create a new playlist. (See "Creating a new playlist" on page 82.)

30 Level meters

These are the same as on the timeline mode Home Screen.

2 – Names and functions of parts

31 Time display area

The times displayed depend on the time display mode.

Mode	Left end	Right end
REMAIN	00:00:00:00	Total take or entry length
TOTAL	00:00:00:00	Total session or playlist length
T.REM	00:00:00:00	Total session or playlist length
T/C	Starting time of session or playlist	Ending time of session or playlist

When recording or in recording standby, time and division lines are not shown.

32 Flash Page number and knob

Shows the Flash Page number. Touch to enable selection (yellow background), and turn the **DATA** dial to change the page number (turn right to increase and left to decrease).

33 Current time cursor

Shows the playback position and scrolls horizontally along with the time counter. It is not shown during recording (take mode only).

34 Mark name

This is the name of the mark at the current time or the nearest preceding mark. When the name of a mark other than any automatic mark is shown, Touch to open the **MARK NAME** editing screen.

35 INPUT MONITOR button

This is the same as on the timeline mode Home Screen.

36 EDIT button

Opens a pull-up menu for take editing.

37 NEXT TAKE NAME button

This is the same as on the timeline mode Home Screen.

In on-air mode



On-air mode Home Screen

38 Take name display (button)

Shows the icon and name of the currently active take. Touch to open a pull-down menu.



ON AIR LIST button

Touch to open the **ON AIR LIST** screen. (See "Selecting files for playback" on page 97.)

REBUILD button

This rebuilds the additional index files for HS-2000 when files have been deleted or modified remotely using a FTP client, for example.

39 Information area

On the on-air mode Home Screen, the information area shows the names of the next two takes. Touch this information area to open the **ON AIR LIST** screen.

40 ON AIR button

Switch between broadcast playback mode and rehearsal/confirmation playback mode. (See "Using the ON AIR button to switch between rehearsal/confirmation playback and broadcast playback modes" on page 98.)

④ CREDITS playback button

Touch to start credit playback, which plays back from the beginning of the selected file and stops at the appropriate mark.

(See “Credits playback” on page 98.)

NOTE

- The ON AIR button only functions when the transport is stopped.
- The CREDITS button can be used when the ON AIR button is OFF and the transport is stopped or during CREDITS playback. It cannot be used when the ON AIR button is ON and during ordinary playback.
- During credits playback, you can press the CREDITS button to stop playback. (Use to toggle credits playback ON/OFF.)

3 – Preparations

Inserting and removing CF cards

Inserting CF cards

Insert a CF card into a CF card slot on the front of the unit in order to use it for recording and playback.

NOTE

CF cards can be inserted whether the power is ON or OFF.

1. Pull the CF card slot cover forward to open it.

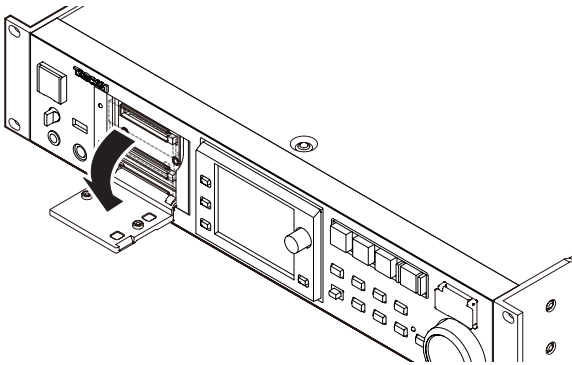

2. Insert the CF card with the correct orientation. With the labeled side up, insert the end with the connector completely.

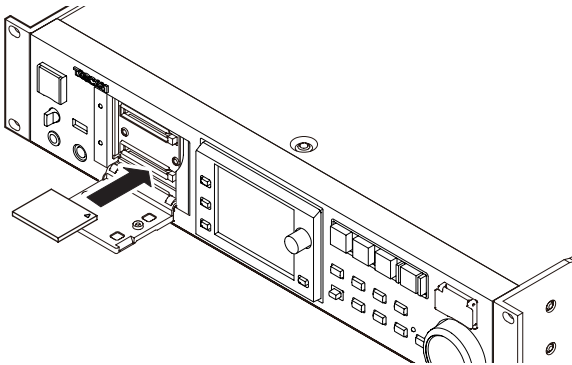

3. Close the cover.

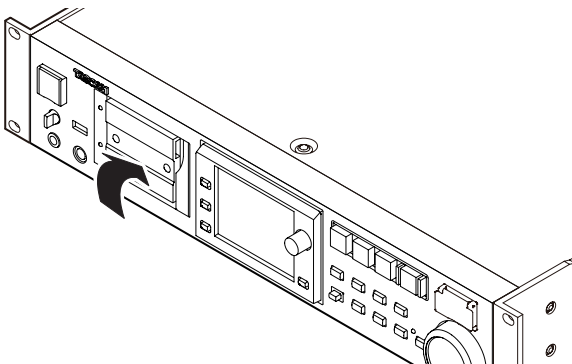

NOTE

If you cannot close the slot cover, remove the CF card once, press the square button to the right of the slot and then reinsert the card.

Removing CF cards

Turn the unit power OFF or stop operations before removing a CF card.

CAUTION

Never remove a CF card during recording, playback or any other operation that accesses the CF card. Doing so could, for example, cause recording errors, loss of recorded data, and sudden loud noises to be output through monitoring equipment, which could result in damaged equipment and hearing loss.

1. Pull the CF card slot cover forward to open it.
2. Press the square button to the right of the CF card slot to bring the button out.
3. Press the square button in again to partially eject the CF card.

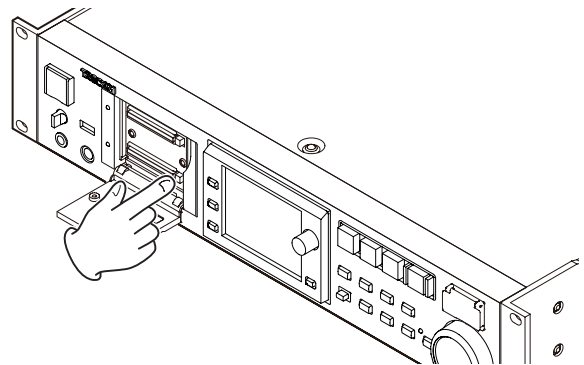

4. Pull the CF card out by hand.

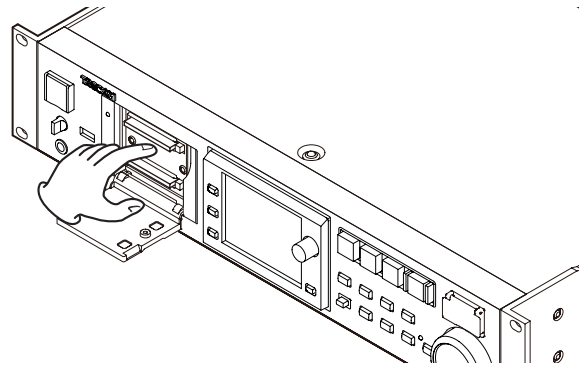

Security screws

The included security screws can be used to lock the CF card slot cover.

Use a Phillips head screwdriver to install or remove the screws.

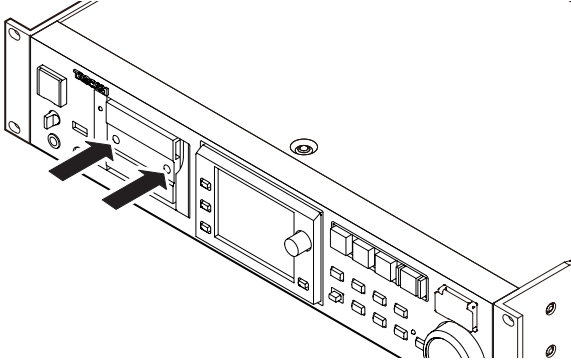

About the display

Adjusting the display angle

Push the **LCD TILT** button to unlock the display, and then pull the bottom of the display forward to adjust the angle. Pull the bottom of the display until you hear a clicking sound.

To restore it to its flat position, push the **LCD TILT** button again to unlock the display, and push the bottom of the display. Push the bottom of the display until you hear a clicking sound.

CAUTION

Do not push the display screen itself.

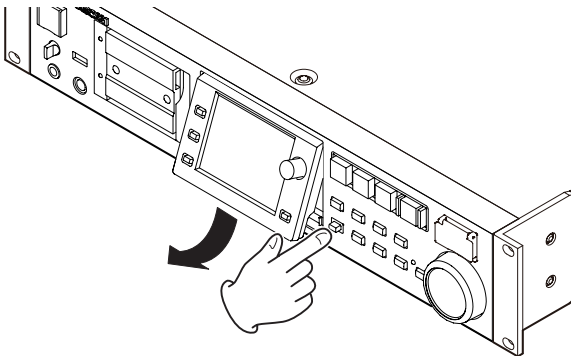

Adjusting display and indicator brightness

Turn the **DATA** dial while pressing and holding the **HOME** key to adjust the brightness of the color display, the **PAUSE**, **REC**, **PLAY** and **ON LINE** keys, and the **JOG [SHUTTLE]**, **SLOT 1** and **SLOT 2** indicators. Push and turn the **DATA** dial while pressing and holding the **HOME** key to adjust only the brightness of the color display.

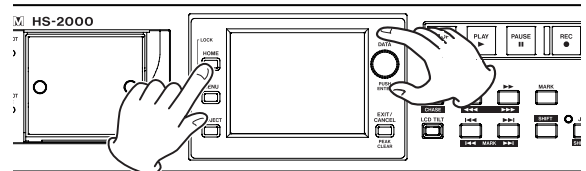

Cautions related to display use

- The display can easily be scratched, so do not use pointed objects, including fingernail tips, to touch it. Always touch it with your fingers.
- Do not press the display forcefully with a finger or poke it with a pen, toothpick or other pointed object. Doing so could scratch the display or cause malfunction.
- The display touch screen is constructed of a film and glass. Do not apply strong force to its surface. Doing so could break the glass.
- When using the display, do not put a hand on the panel or push around the display forcefully. Doing so could prevent accurate position detection.
- Do not place anything on top of the display or otherwise put weight on the same place for a long time. Doing so could cause the panel to warp or result in inaccurate position detection.
- Do not apply a commercially-available screen protection film to the display. Doing so could prevent normal operation.
- Gently wipe the display with a soft dry cloth that does not shed dust (e.g. a cleaning cloth). Avoid wiping with a stiff cloth or rubbing with force. Doing so could damage the surface of the LCD. Do not use benzene, thinner, manicure remover, alcohol or similar substances.

NOTE

The display is produced with extremely high-precision manufacturing technologies, and 99.99% or more of the pixels are effective, but sometimes pixels might not appear or might appear as red or black dots. This is not a malfunction.

3 – Preparations

Turning the power ON and OFF

Open the front panel **POWER** switch cover and press the **POWER** switch.

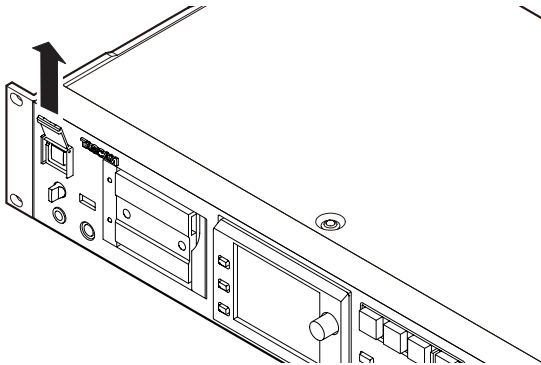

Startup screen

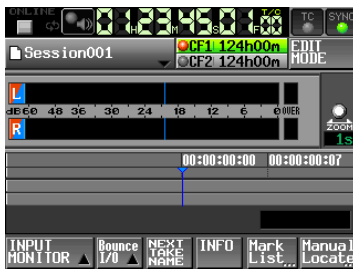

Home Screen

To turn the power OFF, push the **POWER** switch on the front panel again.

CAUTION

Never turn the power OFF during recording, playback, or any other operation that accesses the CF card. Doing so could, for example, cause recording errors, loss of recorded data, and sudden loud noises to be output through monitoring equipment, which could result in damaged equipment and hearing loss.

Setting the built-in clock

1. Press the **MENU** key on the front panel to open the **MENU** screen.

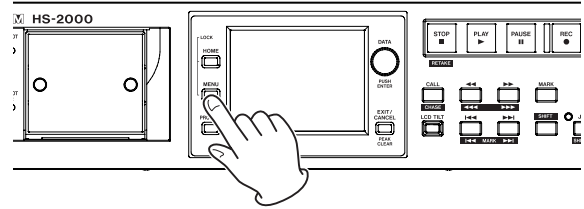

2. Touch the **SYSTEM SETUP** button to open the **SYSTEM SETUP** screen.

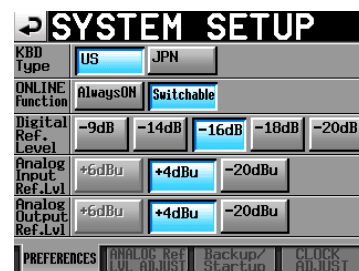

3. Touch the **CLOCK ADJUST** tab to open the **CLOCK ADJUST** page where you can set the built-in clock.

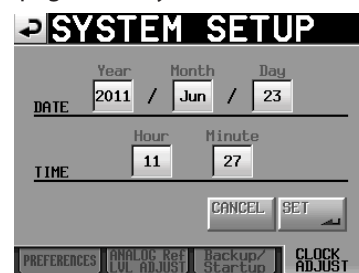

4. Touch the item that you want to change, and use the **DATA** dial on the front panel to change the value.

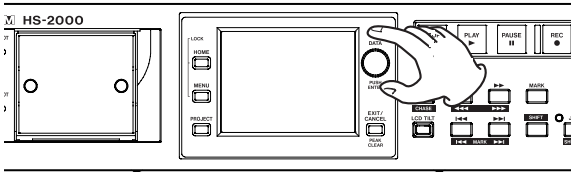

5. Touch the SET button or push the **DATA** dial to confirm the setting.

NOTE

After purchasing this unit, set the clock before making your first recording. If you do not set the clock, the time stamps on recording files will be incorrect.

Lock function

Press the **MENU** key while pressing and holding the **HOME** key on the front panel to open the **LOCK SETUP** screen where you can disable or enable operation from the front panel and external devices.

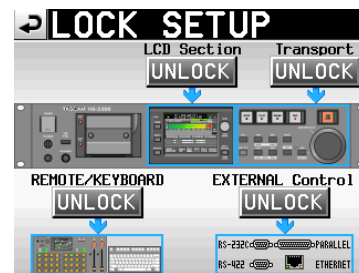
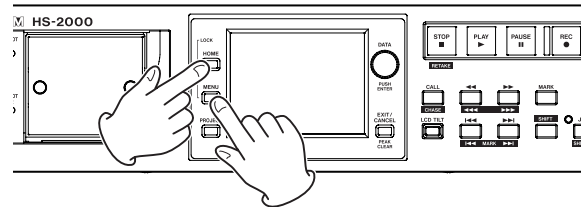

The front panel is divided into two sections, which can be locked and unlocked separately. Control from external devices is also divided into two categories, which can be locked and unlocked separately. If you press the button for a section, it changes from UNLOCK to LOCK (with a yellow background) and the locked area appears dimmed.



LOCK SETUP screen with all sections locked

3 – Preparations

- When the LCD Section is set to LOCK:

- If the display is touched, the following pop-up message appears.

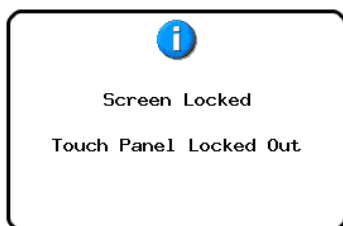

Touch panel display (LCD) locked

- If one of the keys around the display is pressed, the following pop-up message appears.

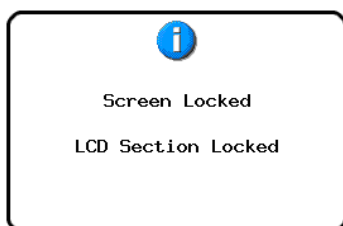

Keys around display (LCD) locked

- When the Transport section is set to LOCK, if one of the transport keys is pressed, the following pop-up message appears.

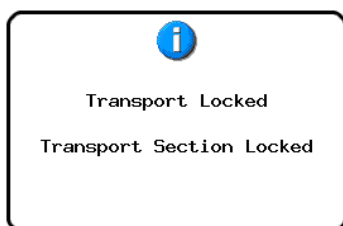

Transport section locked

- When the REMOTE/KEYBOARD section is set to LOCK, if a remote control or keyboard connected to a remote connector is used, the following pop-up message appears.

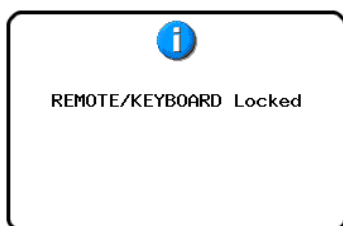

Remote/keyboard control locked

- When the EXTERNAL CONTROL section is set to LOCK, if an operation is conducted through the RS-232C, RS-422, PARALLEL or ETHERNET connections, the following pop-up message appears.

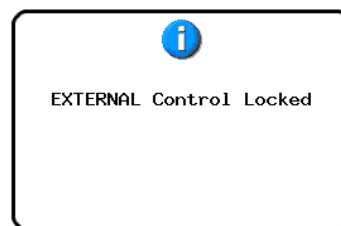

Other external control locked

Recording ties

The table below shows the total amount of recording tie (in hours and minutes) possible on CF cards of various capacities for each recording format.

File recording format	Card capacity		
	8 GB	16 GB	32 GB
16-bit/44.1kHz	12:34	25:10	50:21
16-bit/48kHz	11:32	23:07	46:16
24-bit/44.1kHz	8:22	16:46	33:34
24-bit/48kHz	7:41	15:24	30:50
24-bit/88.2kHz	4:11	8:23	16:47
24-bit/96kHz	3:50	7:42	15:25
24-bit/176.4kHz	2:05	4:11	8:23
24-bit/192kHz	1:55	3:51	7:42

- The recording times shown above are estimates. They might differ depending on the CF card in use.
- The recording times shown above are not continuous recording times, but rather they are the total possible recording times for the CF card.

4 – Basic operation

In this chapter, we explain the basic operation procedures that are the same in each operation mode. The display functions as a touchscreen.

Operate the unit using its keys, switches and touchscreen display buttons.

On every screen except the Home Screen, a  button appears at the top left. Touch to return to the previous screen.

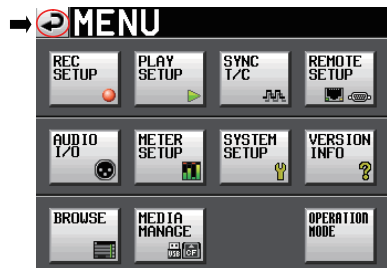

NOTE

You can also return to the previous screen by pressing the **EXIT/CANCEL [PEAK CLEAR]** key.

CF card preparation

Card selection

1. Press the **MENU** key on the front panel to open the **MENU** screen.

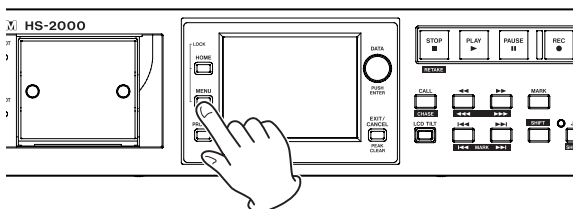

2. Touch the **MEDIA MANAGE** button to open the **MEDIA MANAGE** screen.

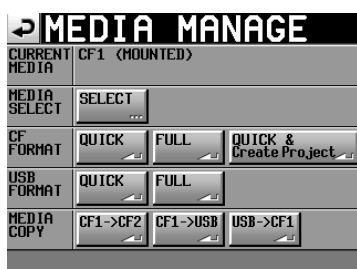

3. Touch the **MEDIA SELECT** button next to the **SELECT** item to open the **SELECT** screen.

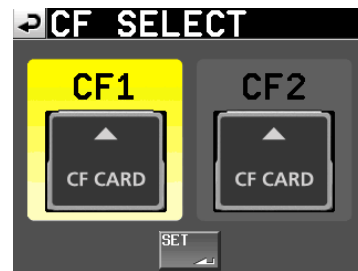

NOTE

You can also open **MEDIA SELECT** screen by touching the recording media button on the Home Screen.

4. Touch the button for the card that you want to use to select it. The background of the selected card appears yellow.
5. Touch the **SET** button to return to the **MEDIA MANAGE** screen.
6. If you also want to format the card now, follow the procedure starting with step 3 in “Formatting a CF card” in the next section

4 – Basic operation

Formatting a CF card

CAUTION

- Formatting a CF card erases all the data on it.
- Always format a CF cards with this unit before using them. If a CF card that has been formatted by another device or PC is used, operation might be affected.

1. Press the **MENU** key on the front panel to open the MENU screen.

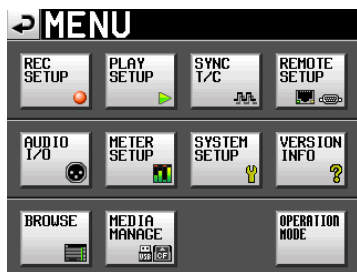
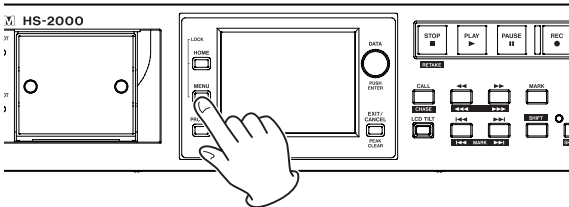

2. Touch the **MEDIA MANAGE** button to open the MEDIA MANAGE screen.

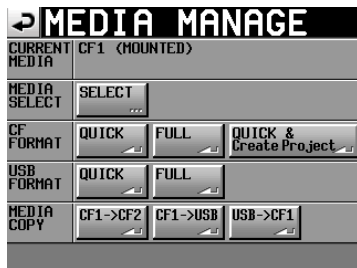

3. Touch the **QUICK** button next to the CF FORMAT item. The following pop-up message appears.

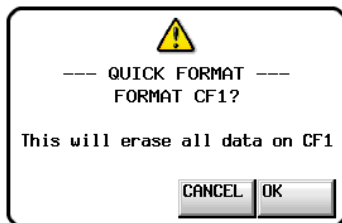

NOTE

If no CF card is inserted in that slot, the following pop-up message appears.



4. A reconfirmation pop-up window appears. Touch the **OK** button in the pop-up window.

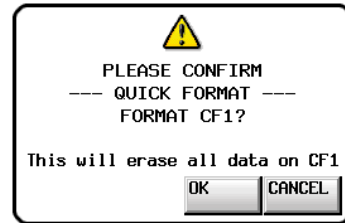

5. Touch the **OK** button in the pop-up window. During formatting, the following pop-up message appears.

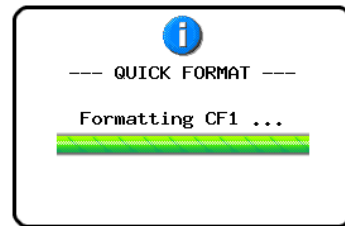

When formatting completes, the following pop-up message appears.

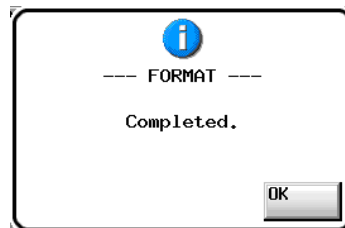

6. Touch the **OK** button in the pop-up window. The **CREATE PROJECT** screen automatically opens.



7. To make a new project, follow the procedures starting with step 2 in "Creating a new project" on page 31.

Creating a project automatically after quick formatting

If you press the **QUICK & Create Project** button instead of the **QUICK** button next to the **FORMAT** item, a new project will be created after the CF card is quick-formatted.

When doing this, however, you cannot change the project settings. The new project will be created with the same settings as the current project.

1. Press the **MENU** key on the front panel to open the **MENU** screen. Then, touch the **MEDIA MANAGE** button on the **MENU** screen to open the **MEDIA MANAGE** screen.

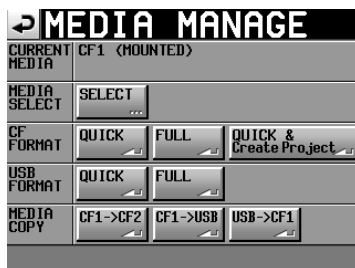

2. Touch the **QUICK & Create Project** button next to the **FORMAT** item. The following pop-up message appears.

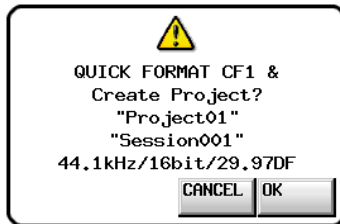

This window shows the project name, session name, sampling frequency, bit rate and frame type in the project to be created.

3. Touch the **OK** button in the pop-up window. Another pop-up window appears to reconfirm.

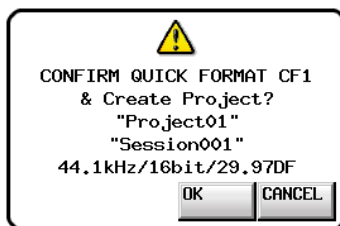

4. Touch the **OK** button in the pop-up window to start quick formatting. After quick formatting completes, a new project is created automatically. After the project is created, the Home Screen reappears.

NOTE

Touch the **CANCEL** button in the pop-up window to cancel formatting and return to the **MEDIA MANAGE** screen.

Creating a new project

1. Press the **PROJECT** key on the front panel to open the **PROJECT** screen.

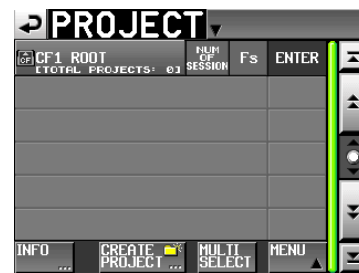
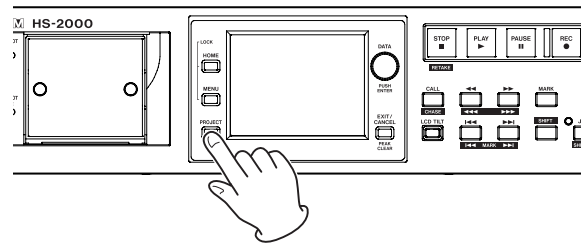

2. Touch the **CREATE PROJECT** button to open the **CREATE PROJECT** screen.



The **CREATE PROJECT** screen has 3 pages. On the first page, you can change the project name, the name of the first created session, the sampling frequency, and the sampling frequency written to BWF chunks.

For details about each item, see “Creating new projects” on page 38.

3. Touch the **NEXT** button to open the next page. On this page, you can change the frame type and bit length.

NOTE

Instead of touching the **NEXT** button, you can touch the **CREATE PROJECT** button on **CREATE PROJECT** screen page one (1/3 at the bottom of the page) to create a project with the current settings without adjusting them on the following screens. Touching the **CREATE PROJECT** button on **CREATE PROJECT** page two (2/3) has the same effect. In either case, continue the procedures from step 6.

4. Touch the **NEXT** button again to open the third page [3/3] where you can set the starting time in timeline mode, for example. For details about each item on **CREATE PROJECT** screens 1–3, see “Creating new projects” on page 38.

4 – Basic operation

- After you complete making settings touch the **CREATE PROJECT** button.

NOTE

If a project with the same project name already exists, the **CREATE PROJECT** button appears gray and you will not be able to create a new project. If this happens, change the project name.

- A confirmation pop-up will appear. Confirm the settings, and touch the **OK** button in the pop-up window to return to the Home Screen.

Setting the master clock

- Press the **HOME** key on the front panel to open the Home Screen.

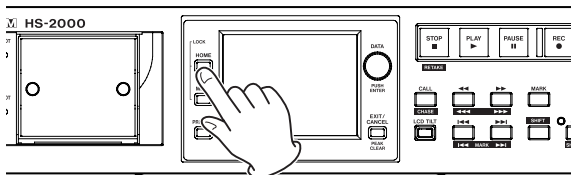

- Touch the **SYNC** button to open the **SYNC T/C** screen.

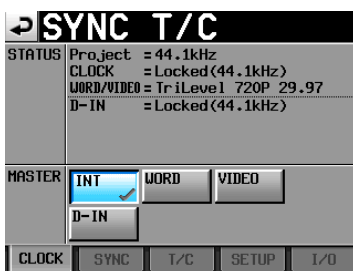

NOTE

You can also open the **SYNC T/C** screen by touching the **SYNC T/C** button on the **MENU** screen.

- Select the master clock that you want to use from the **MASTER** item. (See “Sync and timecode settings (SYNC T/C)” on page 103.)

Setting inputs and outputs

Setting the inputs

- Press the **MENU** key on the front panel to open the **MENU** screen.

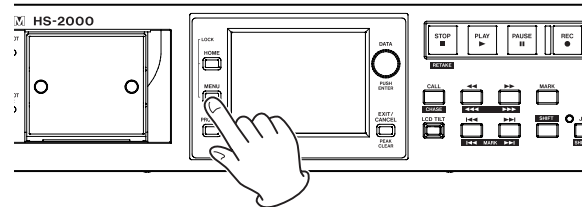

- Touch the **AUDIO I/O** button to open the **AUDIO I/O** screen.



On the **INPUT** page, make settings for each channel's input source. For details, see “**INPUT** page” on page 110.

- If necessary, touch the **OUTPUT** or **SETUP** tab to open the corresponding page where various settings can be made.

On the **OUTPUT** page, make settings related to the output and signal routing. For details about this screen, see “**OUTPUT** page” on page 110.

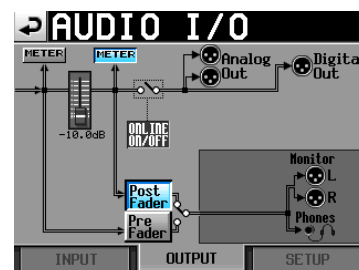

On the **SETUP** page, you can turn the muting function for monitoring during online playback ON/OFF. For details about this screen, see "Setting audio signal inputs and outputs (SETUP page)" on page 110.



Setting reference levels

1. Press the **MENU** key on the front panel to open the **MENU** screen.

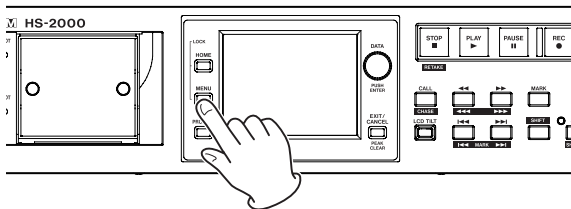

2. Press the **SYSTEM SETUP** button to open the **SYSTEM SETUP** screen.

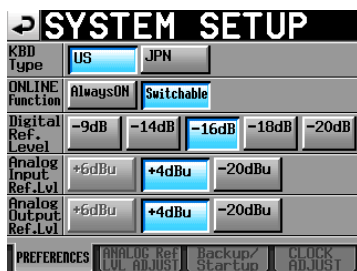

On the **PREFERENCES** page, set the digital reference level, analog input reference level and analog output reference level. (You can also set the keyboard type and online function on this page.) For details, see "PREFERENCES page" on page 112.

3. If necessary, touch the **ANALOG Ref LEVEL ADJUST** tab and adjust each channel.

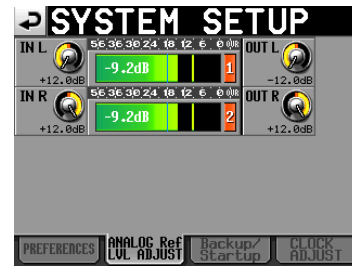

On the **ANALOG Ref LEVEL ADJUST** page, you can make precise adjustments to the reference levels of the analog inputs and outputs for each channel independently. For details about this screen, see "ANALOG Ref LEVEL ADJUST page" on page 113.

NOTE

You can change the system time on the **CLOCK ADJUST** page.

Connecting headphones

Connect headphones to the **PHONES** jack on the front panel. Keep the headphones knob turned all the way to the left (volume minimized) when connecting headphones.

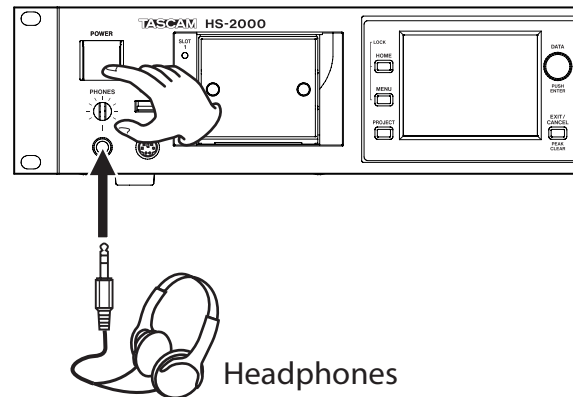

CAUTION

Before connecting headphones, turn the **PHONES** knob to the minimum volume. Failure to do so could result in sudden loud noises, which might damage your hearing or equipment.

4 – Basic operation

Using online functions

Turn the **ON LINE** key ON to enable sound to be output through the output connectors. (The **ON LINE** key on the front panel has a cover, so open this cover to press it.)

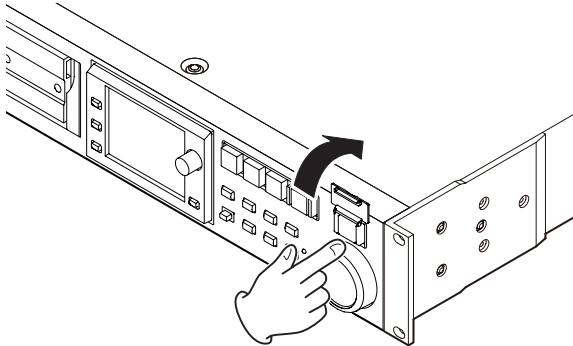

The **ON LINE** key lights when ON.

You can also connect a TASCAM HS32PD/RC-HS20PD remote controller (sold separately), for example, and use its master fader to adjust the level suitably. When the master fader is lowered completely, sound is not output from the output connectors.

Press the **ON LINE** key again to turn it OFF. That switch becomes unlit, and sound ceases to be output from the output connectors.

For details about the online function, see “Online function” on page 129.

Recording operation limitations

With this unit, recording to a folder can become impossible when the total number of files, subfolders and other items in that folder becomes large. For this reason, the following things might occur.

- **When the total number of items in one folder exceeds about 20,000**

Recording of a new take might not be possible when starting from a stopped state. In addition, when a project or session is loaded, recording to that session might not be possible. In these cases, the following pop-up message appears.

- **When recording/editing is repeated in timeline mode and the available memory space is insufficient**

Repeated recording and editing can result in a shortage of available memory necessary to manage regions and editing history. In this case, recording cannot be performed, and the following pop-up message appears.



In this case, Rec Limit appears for the remaining recording time for the currently selected card on the Home Screen.

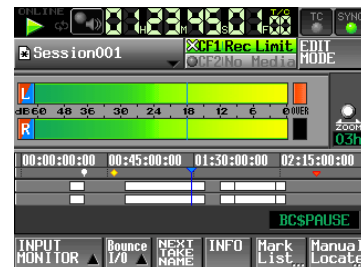

CAUTION

The total number of items inside one folder includes files and folders not created by this unit. Management files, system files and other files and folders that are not ordinarily visible are also included in the total.

Project organization

This unit manages audio files in projects.

A CF card contains project folders, and each project folder contains session folders. The session folders contain audio files, which are called “takes”.

Project	Contains all materials for one program or work
Session	Collection of materials within a project
Take	Recorded materials in a session

CAUTION

Each project has a fixed sampling frequency, and can only contain audio files of that sampling frequency.

File formats

This unit can record and play files of the following formats.

File format	BWF/WAV*
Sampling frequency	44.1, 47.952, 48, 48.048, 88.2, 96, 176.4, 192 kHz (47.952, 48.048: 48 kHz ± 0.1% pull-down/pull-up)
Bit-length	16/24-bit
Number of tracks	2

*This unit always records BWF files. It cannot record standard WAV files, but can play them.

Using the PROJECT screen

Press the **PROJECT** key on the front panel to open the PROJECT screen. The last used PROJECT screen page (project selection, session selection, AES31 file selection, take selection or playlist selection) opens.

The following explanations assume that the PROJECT selection screen is open.

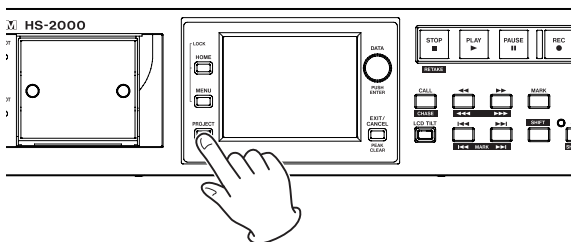

Project selection screen

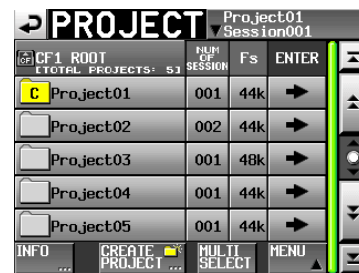

- Directory**
 The current directory level and the number of projects are shown. (In the example above, the root directory of the CF card contains five projects)
- NUM OF SESSION**
 This shows the number of sessions in each project.
- Fs**
 This shows the sampling frequency of the project. Sampling frequency values are abbreviated as follows.

Sampling frequency	Fs abbreviation
44.1 kHz	44k
47.952 kHz (48 kHz – 0.1% pull-down)	48k–
48.048 kHz (48 kHz + 0.1% pull-up)	48k+
88.2 kHz	88k
176.4 kHz	176k

- ENTER buttons**
 Touch the → button for the current project to view the contents of that project. The icon **C** of the currently loaded project has the letter “C” and is yellow.
 If you touch the → button for any project other than the current project a pop-up window will appear to confirm that you want to load that project. Touch the **OK** button to load the project and show its contents after it completes loading.
- Project name buttons**
 Touch to select that project.
 The icon **C** of the currently loaded project has the letter “C” and is yellow.
- INFO button**
 Touch to open a pop-up window that shows information about the project that is currently selected. If no project is selected, press this button to show information about the entire card.
- CREATE PROJECT button**
 Touch to open the **CREATE PROJECT** screen.
- MULTI SELECT button**
 Touch to enable the selection of multiple projects.

5 – Projects

- **MENU button**
Touch to open a pull-up menu where you can select **LOAD**, **REBUILD**, **EDIT NAME** and **DELETE**.
- **Scroll buttons**
Use these buttons to scroll to the beginning or end of the project list or scroll one page (five lines) forward or backward. You can also use the **DATA** dial to scroll through the project list one line at a time.
- **Project and session names at top right**
Touch to open the following screen according to the current mode.

Timeline mode	AES31 file selection screen for the current session
Take mode	Take selection screen for the current session
Playlist mode	Playlist selection screen for the current session

Session selection screen



- **Project name**
This shows the current project name.
Touch to open the project selection screen.
- **NUM OF TAKE (timeline and take modes)**
This shows the number of takes in the session.
- **TOTAL TIME (timeline and take modes)**
This shows the total time of the takes in the session.
- **NUM OF PLAYLISTS (playlist mode)**
This shows the number of playlists in the session.
- **ENTER buttons**
Touch the → button for the current session to view its contents. The icon **C** of the currently loaded session has the letter "C" and is yellow.
If you touch the → button for any session other than the current session a pop-up window will appear confirming that you want to load that session. Touch the **OK** button to load that session and show its contents.
- **Session name buttons**
Touch to select that session.
The icon **C** of the currently loaded session has the letter "C" and is yellow.
- **INFO button**
Touch to open a pop-up window that shows information about the session that is currently selected.

If no session is selected, press this button to show information about the current project.

- **MAKE SESSION button**
Touch to open a screen where you can create a new session.
- **MULTI SELECT button**
Touch to enable the selection of multiple sessions.
- **MENU button**
Touch to open a pull-up menu where you can select **LOAD**, **REBUILD**, **EXPORT** and **DELETE**.
- **Scroll buttons**
Use these buttons to scroll to the beginning or end of the session list or scroll one page (five lines) forward or backward. You can also use the **DATA** dial to scroll through the session list one line at a time.
- **Project and session names at top right**
Touch to open the following screen according to the current mode.

Timeline mode	AES31 file selection screen for the current session
Take mode	Take selection screen for the current session
Playlist mode	Playlist selection screen for the current session

AES31 file selection screen

The AES31 file selection screen is only shown when in timeline mode.



- **Session name**
This shows the current session name.
Touch to open the session selection screen.
- **LOAD → buttons**
Touch the → button for the corresponding AES31 file to import its editing information.
- **AES31 file name buttons**
Touch to select the corresponding AES31 file.
- **INFO button**
Touch when an AES31 file is selected to open a pop-up window with information about the selected file.
Press when no AES31 file is selected to show information about the current session.
- **CREATE AES31 button**
Touch to open a screen for creating new AES31 files.
- **MENU button**
Touch to open a pull-up menu where you can select LOAD, EDIT NAME and DELETE.

Take selection screen

The take selection screen is only shown when in take mode.



- **Session name**
This shows the current session name.
Touch to open the session selection screen.

NOTE

The session selection screen cannot be opened from a take selection screen opened by touching the TAKE LIST button in the pull-down menu that appears after you touch a take name button on the Home Screen.

- **LENGTH**
Shows the take length (time).
- **LOAD → buttons**
Press a take's → button to load that take.
- **Take name buttons**
Touch to select a take.
The icon of the currently loaded take has the letter "C" and is yellow.
- **INFO button**
Touch to open a pop-up window that shows information about the selected take.
If no take is selected, press this button to show information about the current session.
- **CIRCLE @ TAKE button**
Touch when a take is selected to add an "@" to the beginning of that take's name. If that take already has "@" at its beginning, touch this to remove it.
- **MULTI SELECT button**
Touch to enable the selection of multiple takes.
- **MENU button**
Touch to open a pull-up menu for selecting LOAD, REBUILD, EDIT TC, EXPORT, DELETE, SORT, MOVE and EDIT NAME.
- **Scroll buttons**
Use these buttons to scroll to the beginning or end of the take list or scroll one page (five lines) forward or backward. You can also use the **DATA** dial to scroll through the take list one line at a time.

5 – Projects

Playlist selection screen

The playlist selection screen is only shown when in playlist mode.



- **Session name**
Shows the current session name.
Touch to open the session selection screen.
- **LOAD → buttons**
Touch a → button to open a pop-up to confirm that you want to load that playlist.
- **Playlist name buttons**
Touch to select a playlist.
The icon of the currently loaded playlist has the letter "C" and is yellow.
- **INFO button**
Touch to open a pop-up window that shows information about the selected playlist.
If no playlist is selected, press this button to show information about the current session.
- **CREATE PLAYLIST button**
Shows the screen for creating a new playlist.
- **MENU button**
Touch to open a pull-up menu where you can select LOAD, EDIT NAME and DELETE.
- **Scroll buttons**
Use these buttons to scroll to the beginning or end of the playlist or scroll one page (five lines) forward or backward. You can also use the **DATA** dial to scroll through the playlist one line at a time.

Project operations

Creating new projects

1. Press the **PROJECT** key on the front panel to open the PROJECT screen.
2. Touch the **CREATE PROJECT** button on the PROJECT screen to open the **CREATE PROJECT** screen.

This screen has three pages.



CREATE PROJECT screen 1

You can make the following settings on this screen.

- **Project Name**
Touch the Project Name button to open a screen where you can edit the project name.
Up to 31 characters can be used for project and session names. Extra characters are discarded.
- **Session Name**
Touch the Session Name button to open the 1st Session screen where you can change the name given to the first session created.
On the 1st Session screen, the maximum number of characters allowed is indicated by a yellow background.
- **Fs**
Set that sampling frequency for the project.
- **BWF Chunk Fs**
Set the sampling frequency written to the BWF chunk of each recorded audio file. To use the actual sampling frequency of the recordings, select Actual Rate.
For pull-up/pull-down, select Fake Rate to write 48k instead of 48k ± 0.1%.

■ **NEXT button**

Touch to open the next page.

■ **CREATE PROJECT button**

Touch this to create a project with the current settings.

If a project with the same name already exists, this button appears gray and you will not be able to create a new project.

3. After you complete making settings, press the **NEXT** button.

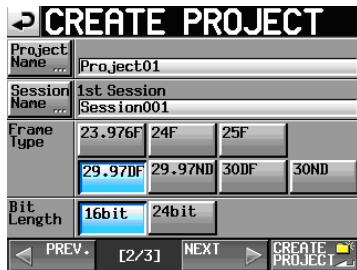

CREATE PROJECT screen 2

You can make the following settings on this screen.

■ **Frame Type**

Set the timecode frame type.

■ **Bit Length**

Set the bit length used to record.

■ **PREV button**

Open the previous screen.

4. After you finish making settings, press the **NEXT** button.



CREATE PROJECT screen 3

You can make the following settings on this screen.

■ **TIMELINE START TIME**

Set the starting time used in timeline mode. Press the

EDIT button to open a screen where you can change the starting time.

■ **OTHERS**

Touch the **Current Setting** button to use the current settings for parameters other than those that appear on the Create Project screens when creating a project.

Touch **Factory Preset** to use the default settings instead.

5. After you finish making settings, touch the **CREATE PROJECT** button.

NOTE

- If a project with the same project name already exists, the **CREATE PROJECT** button appears gray and you will not be able to create a new project. If this happens, change the project name.
- On screens 2 and 3, press the **PREV** button to return to the previous screen.

6. When the confirmation pop-up appears, press the **OK** button.



When project creation completes, the Home Screen reappears.

NOTE

- Immediately after creation, the new project becomes the current (loaded) project.
- On the **PROJECT** screen, the icon to the left of the currently loaded project has the letter "C" and is yellow.

5 – Projects

Editing project names

Similar procedures can also be used to enter and edit session and take names, for example.

1. Touch the Project Name button on the CREATE PROJECT screen to open the PROJECT NAME screen.



CAUTION

Screens where names are inputs such as the PROJECT NAME screen cannot display any characters other than alphanumeric characters and symbols. If characters other than alphanumeric characters and symbols are contained in a name, those characters will be removed when a name input screen such as the PROJECT NAME screen is displayed.

■ Date button

Touch to change the project name to the currently set date in a “yyyy-mm-dd” format.

If the same project name or session name already exists, an underscore (_) followed by a number not already in use is added.

NOTE

- After pressing the Date button to change the name to the current date, you can further edit the name on this screen.

■ Project name display area

The input project name is shown.

The maximum number of characters allowed is indicated by the yellow background.

■ Character buttons

Use to input the project name.

■ BS button

Use to erase the character to the left of the cursor.

■ DEL button

Use to erase the character to the right of the cursor.

■ Shift button

Touch to switch between numerals and symbols and uppercase and lowercase letters.

■ Caps button

Use to input uppercase letters.

■ Space button

Use to input a space.

■ <- / -> button

Use these to move the cursor.

■ Enter button

Touch this to confirm the input name.

NOTE

When the PROJECT NAME screen is open, you can also use an external keyboard to input names.

2. Touch the Enter button on the PROJECT NAME screen or press the DATA dial to confirm the project name.

Character input limitation

The maximum number of characters allowed is indicated by the yellow background in the project name display area. Excess characters have a gray background and are discarded when the Enter button is pressed.

Changing project names later

1. Select the project that you want to change on the PROJECT screen. The background of the selected project name appears yellow.
2. Touch the MENU button on the PROJECT screen to open its pull-up menu.

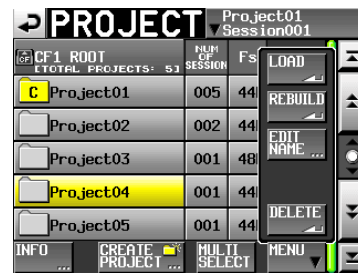

3. Touch the EDIT NAME button in the pull-up menu to open the PROJECT NAME screen.

NOTE

When multiple projects are selected, the EDIT NAME button in the pull-up menu cannot be used.

4. Input the project name using the procedures described above.
5. Touch the Enter button on the PROJECT NAME screen or press the DATA dial to confirm the project name and return to the PROJECT screen.

Editing the name of the first session

Touch the **Session Name** button on the **CREATE PROJECT** screen to open the **1st SESSION** screen, as shown below.

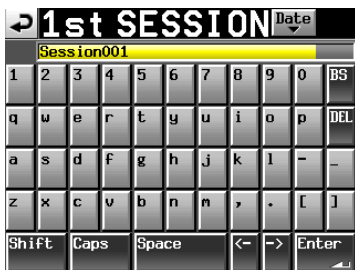

Follow the same procedures as in “Editing project names” on page 40 to change the name.

NOTE

The name of a session cannot be changed after the session is created.

Loading projects

1. Press the **PROJECT** key on the front panel to open the **PROJECT** screen.

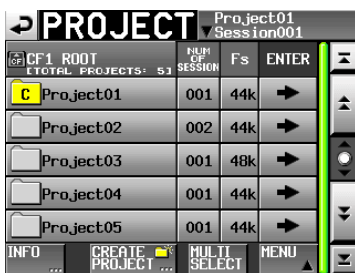

2. Select the project to load.
3. Touch the **MENU** button on the **PROJECT** screen to open its pull-up menu.
4. Touch the **LOAD** button in the pull-up menu.

NOTE

When multiple projects are selected, the **LOAD** item cannot be used.

5. Touch the **OK** button or press the **DATA** dial when the confirmation pop-up message appears. After loading completes the Home Screen opens.



Rebuilding projects

You should rebuild a project whenever there is an inconsistency between the unit's project management file and the audio files. This can occur when an audio file has been deleted from the unit via FTP, for example.

1. Press the **PROJECT** key on the front panel to open the **PROJECT** screen.
2. Select the project that you want to rebuild. You can use the **MULTI SELECT** button on the **PROJECT** screen to allow the selection of multiple projects.
3. Touch the **MENU** button on the **PROJECT** screen to open its pull-up menu.

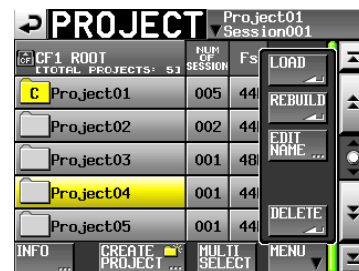

One project selected

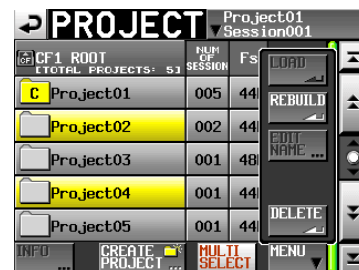

Multiple projects selected

4. Touch the **REBUILD** button in the pull-up menu.
5. When a confirmation pop-up appears, touch the **OK** button or press the **DATA** dial.



During rebuilding, a progress status pop-up appears. When rebuilding completes, the pop-up disappears.

NOTE

If you select **REBUILD** when no project has been selected in the **PROJECT** screen, the entire content of the selected card will be rebuilt.

5 – Projects

Deleting a project

1. Press the **PROJECT** key on the front panel to open the **PROJECT** screen.
2. Select the project that you want to delete.
You can use the **MULTI SELECT** button on the **PROJECT** screen to allow the selection of multiple projects.
3. Touch the **MENU** button on the **PROJECT** screen to open its pull-up menu.

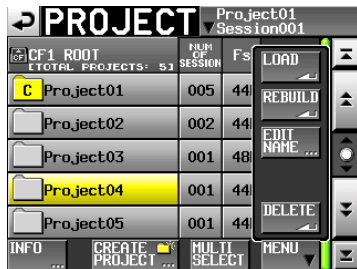

One project selected

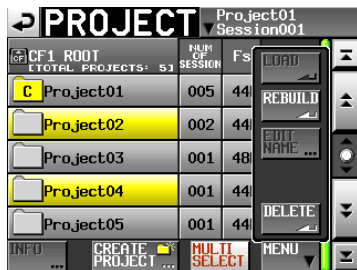

Multiple projects selected

4. Touch the **DELETE** button in the pull-up menu.
5. When a confirmation pop-up appears, touch the **OK** button or press the **DATA** dial.



During deletion, a progress status pop-up appears. When deletion completes, the pop-up disappears.

CAUTION

Deleting a project also deletes all session folders, timeline data, takes and playlists in the project.

Session operations

Creating new sessions

1. Press the **PROJECT** key on the front panel to open the **PROJECT** screen.
2. Touch the **→** button of the project to which you want to add a session to open the session selection screen. If the project is not the current project, a pop-up window appears confirming that you want to load it. Touch the **OK** button.



3. Touch the **MAKE SESSION** button to open the **MAKE SESSION** screen.



You can make the following settings on this screen.

■ Session Name

Touch to open a screen where you can change the name of the session.

Session names can have up to 31 characters. Extra characters are discarded. The maximum number of characters allowed is indicated by a yellow background.

■ TIMELINE START TIME

Touch the **EDIT** button to open a screen where you can change the starting time in timeline mode.

CAUTION

- The name of a session cannot be changed after the session is created.
- You cannot use the "@" symbol at the beginning of a session name.

4. Touch the **MAKE SESSION** button.
5. When a confirmation pop-up appears, touch the **OK** button or press the **DATA** dial.



While a session is being created, a progress status pop-up appears. When session creation completes, the pop-up disappears.

NOTE

- Immediately after creation, the new session becomes the current (loaded) session.
- On the session selection screen, the icon to the left of the currently loaded session has the letter "C" and is yellow.

Loading sessions

1. Press the **PROJECT** key on the front panel to open the **PROJECT** screen.
2. Touch the \rightarrow button for the project that contains the session that you want to load to open the session list. If this project is not the current project, a pop-up window appears confirming that you want to load it. Touch the **OK** button.
3. Select the session that you want to load.
4. Touch the **MENU** button on the **SESSION** screen to open a pull-up menu.



5. Touch the **LOAD** button in the pull-up menu.
6. When a confirmation pop-up appears, touch the **OK** button or press the **DATA** dial.



After loading completes, the Home Screen opens.

NOTE

On the session selection screen, the icon to the left of the currently loaded session has the letter "C" and is yellow.

Rebuilding sessions

You should rebuild a session whenever there is an inconsistency between the unit's session management file and the audio files. This can occur when an audio file has been deleted from the unit via FTP, for example.

1. Press the **PROJECT** key on the front panel to open the **PROJECT** screen.
2. Touch the \rightarrow button for the project that contains the session that you want to rebuild to open the session selection screen. If the selected project is not the current project, a pop-up window appears confirming that you want to load it. Touch the **OK** button.
3. Select the session that you want to rebuild. Touch the **MULTI SELECT** button to enable the selection of multiple sessions.
4. Touch the **MENU** button on the session selection screen to open a pull-up menu.



One session selected



Multiple sessions selected

5. Touch the **REBUILD** button in the pull-up menu.
6. When a confirmation pop-up appears, touch the **OK** button or press the **DATA** dial.

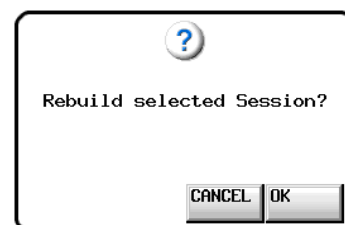

During rebuilding, a progress status pop-up appears. When rebuilding completes, the pop-up disappears.

NOTE

- You can also rebuild a session from that session's take selection screen.
- If you do not select a session on the Session screen, the entire current project will be rebuilt.

5 – Projects

Exporting sessions

You can export session folders from the selected media to other media (two media devices are necessary). When you export a session, the source directory structure is duplicated to the export destination.

CAUTION

Do not export a session to a project with a different sampling frequency. If you do so, the session will not be able to be rebuilt and will not be usable in that project.

NOTE

You cannot export to USB flash memory, but you can copy files to it. For details, see "Copying a folder/file" on page 117.

1. Press the **PROJECT** key on the front panel to open the **PROJECT** screen.
2. Touch the **→** button for the project that contains the session that you want to export to open the session selection screen.
If it is not the current session, a pop-up window appears confirming that you want to load it. Touch the **OK** button.
3. Select the session that you want to export.
Touch the **MULTI SELECT** button to enable the selection of multiple sessions.
4. Touch the **MENU** button on the session selection screen to open a pull-up menu.



One session selected



Multiple sessions selected

5. Touch the **EXPORT** button in the pull-up menu.

6. When a confirmation pop-up appears, touch the **OK** button or press the **DATA** dial.



During export, a progress status pop-up appears. When export completes, the pop-up disappears.

CAUTION

If a session with the same name already exists on the destination media, the following confirmation pop-up will appear.



Touch the **OK** button or press the **DATA** dial to delete the existing session on the destination media and replace it with the session being exported.

Deleting sessions

1. Press the **PROJECT** key on the front panel to open the **PROJECT** screen.
2. Touch the **→** button for the project that contains the session that you want to delete to open the session selection screen. If the selected project is not the current project, a pop-up window appears confirming that you want to load it. Touch the **OK** button.
3. Select the session that you want to delete. Touch the **MULTI SELECT** button to enable the selection of multiple sessions.
4. Touch the **MENU** button on the session selection screen to open a pull-up menu.



One session selected



Multiple sessions selected

5. Touch the **DELETE** button in the pull-up menu.
6. When a confirmation pop-up appears, touch the **OK** button or press the **DATA** dial.

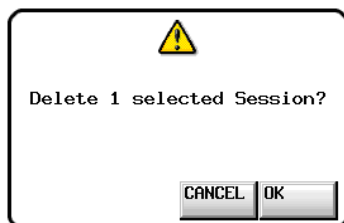

During deletion, a progress status pop-up appears. When deletion completes, the pop-up disappears.

CAUTION

When you erase a session, all timeline **DATA**, takes and playlists in the folder are also erased.

Switching project screens

When you press the **ENTER** button or a folder name (project name or session name) button on a project screen (project selection screen, session selection screen, AES31 file selection screen, take selection screen, playlist selection screen), a different screen will open as shown below.

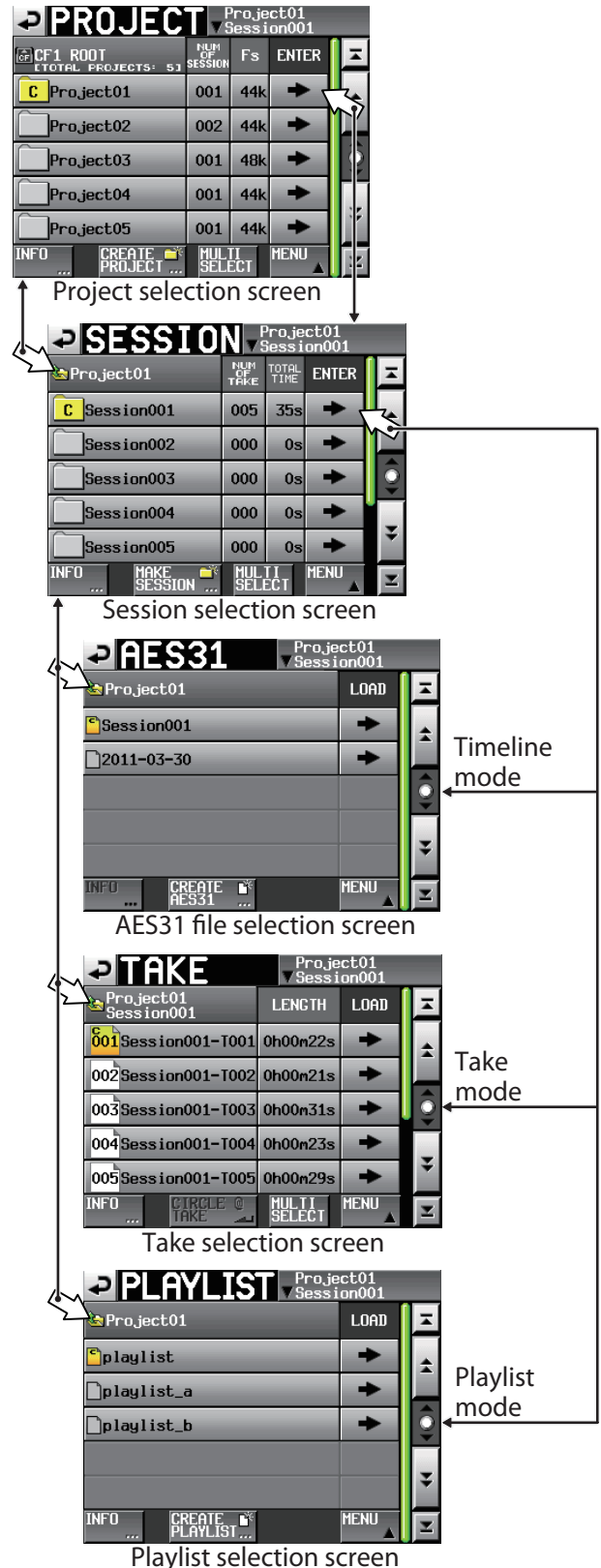

6 – Operation Modes

This unit has the following four operation modes.

● Timeline mode

Timeline mode provides a linear working environment similar to a tape recorder. In timeline mode, two tracks can be recorded and played back. Marks, including BWF-J CUE points, can also be edited.

● Take mode

Take mode uses takes (files) as recording and playback units. Two tracks can be recorded and one or two tracks can be played back.

Marks, including BWF-J CUE points, can also be edited.

● Playlist mode

Playlist mode provides a playlist playback function. One or two tracks can be played back.

● On-air mode

This mode plays back audio files (that match the unit's set sampling frequency) in the root folder of the current card.

Two tracks can be played back.

Timeline mode functions

The following functions can be used in timeline mode.

- Two-channel recording and playback possible at all compatible sampling frequencies (Fs)
- Confidence monitoring allows the audio being recorded to be played back simultaneously (when the sampling frequency is 44.1kHz, 48kHz or 48kHz±0.1% and the REC Mode is Single)
- Mirror recording function using both CF card slots
- Recording and playback synchronized to timecode
- Bounce function can make a single file from a designated section of the timeline
- Marks, including BWF-J CUE points, can be set, managed, edited and used for playback
- AES31 standard compatibility allows exchange of data with other devices

In timeline mode, playback units are called “regions,” and their extent is shown in the track area of the Home Screen.

NOTE

Because the AES31 file standard does not support 176.4kHz or 192kHz sampling frequencies, editing information for projects created using these sample rates will be saved using a TASCAM original format, based on AES31. This format might not be compatible with other products.

Take mode functions

The following functions can be used in take mode.

- Two-channel recording and playback possible at all compatible sampling frequencies (Fs)
- Confidence monitoring allows the audio being recorded to be played back simultaneously (when the sampling frequency is 44.1kHz, 48kHz or 48kHz±0.1% and the REC Mode is Single)
- Mirror recording function using both CF card slots
- Auto cue, auto ready and incremental play functions
- Flash start playback possible using TASCAM RC-HS32PD (3 pages of 32 keys each) RC-HS20PD (5 pages of 20 keys each) or other remote control devices (all sold separately)
- Marks, including BWF-J CUE points, can be set, managed, edited and used for playback

Playlist mode functions

The following functions can be used in playlist mode.

- Playlists can be edited and managed
- Auto cue, auto ready and incremental play functions
- Compatibility with JPPA flash start standards enables the exchange of playlists with other devices.
- Two-channel playback possible at all compatible sampling frequencies (Fs)
- Flash start playback possible using TASCAM RC-HS32PD (3 pages of 32 keys each) RC-HS20PD (5 pages of 20 keys each) or other remote control devices (all sold separately)

On-air mode functions

The following functions can be used in on-air mode.

- Two-channel playback possible at all compatible sampling frequencies (Fs)
- BWF-J CUE point playback
- CREDITS playback

Selecting the operation mode

1. Press the **MENU** key on the front panel to open the MENU screen.

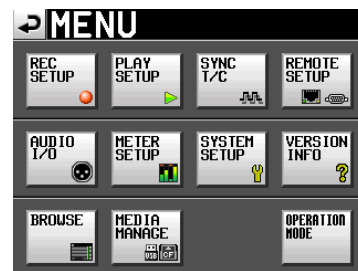
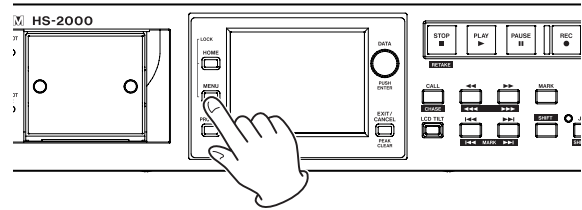

2. Touch the **OPERATION MODE** button to open the OPERATION MODE screen.

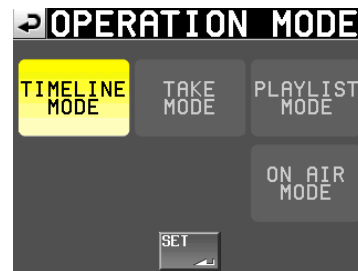

3. Select the mode you want to use by touching its button.
The button for the selected mode appears yellow.
TIMELINE MODE
TAKE MODE
PLAYLIST MODE
ON AIR MODE
4. Touch the **SET** button to enable the selected mode and return to the Home Screen.

7 – Timeline mode

In this chapter, we explain how to use the unit when its operation mode is set to TIMELINE MODE. (See “Selecting the operation mode” on page 47.)

Please refer to “4–Basic operation” when reading this chapter.

Preparing to record

Basic preparations

Refer to “4–Basic operation” and make the basic preparations for recording.

Creating a new project

1. Press the **PROJECT** key on the front panel to open the **PROJECT** screen.
2. Touch the **CREATE PROJECT** button on the **PROJECT** screen to open the **CREATE PROJECT** screen [1/3].



On this screen, set the project name, the name for the first session, the sampling frequency and the sampling frequency written to BWF chunks.

Touch the **NEXT** button to open the next page [2/3].

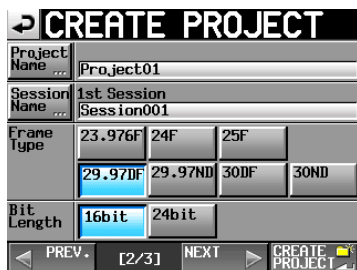

Set the frame type and bit length.

Touch the **NEXT** button to open the next page [3/3].



Finally, set the timeline mode starting time, and then set whether other settings should be retained from the

currently open project or whether the factory defaults should be used instead.

For further details about these settings, see “Creating new projects” on page 38.

3. After you complete making settings touch the **CREATE PROJECT** button.

NOTE

- If a project with the same project name already exists, the **CREATE PROJECT** button appears gray and you will not be able to create a new project. If this happens, change the project name.
- You can also touch the **CREATE PROJECT** button on **CREATE PROJECT** screens 1/3 and 2/3 to create a project.

4. Touch the **OK** button when the confirmation pop-up message appears.

Creating new sessions

Create new sessions as necessary.

1. Press the **PROJECT** key on the front panel to open the **PROJECT** screen.
2. Touch the **→** button of the project in which you want to create a new session to open its session selection screen.

If the selected project is not the current project, a pop-up window appears confirming that you want to load it. Touch the **OK** button.



3. Touch the **MAKE SESSION** button to open the **MAKE SESSION** screen.



4. Touch the **Session Name** button to open the **SESSION NAME** screen where you can change the session name.



To input the session name follow the same procedures as in “Editing project names” on page 40.

NOTE

You cannot start a session name with the “@” symbol.

5. Touch the **Enter** button or press the **DATA** dial to return to the **MAKE SESSION** screen.
6. If necessary, set the timeline start time.
7. When you have finished making settings, touch the **MAKE SESSION** button.
8. When a confirmation pop-up appears, touch the **OK** button or press the **DATA** dial to return to the Home Screen.

For details about session operations, see “Session operations” on page 42.

Recording mode settings

1. Press the **MENU** key on the front panel to open the **MENU** screen.

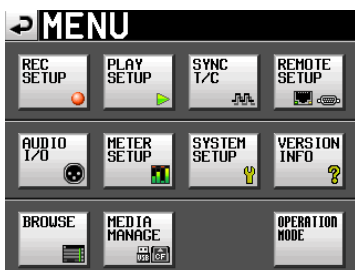
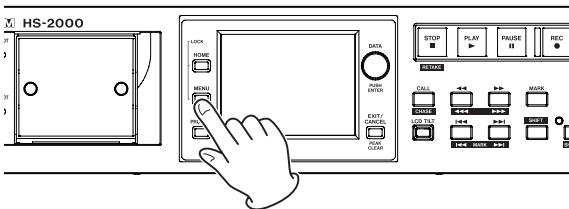

2. Touch the **REC SETUP** button to open the **REC SETUP** screen.

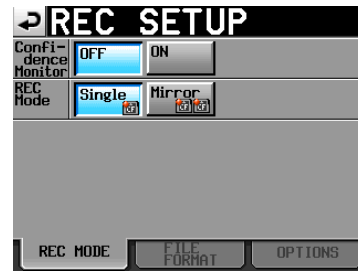

On the **REC MODE** page, you can change the recording mode. The background color for an active setting is light blue. For more details, see “REC MODE page” on page 100.

Setting the file format

Touch the **FILE FORMAT** tab on the **REC SETUP** screen to open the following screen.

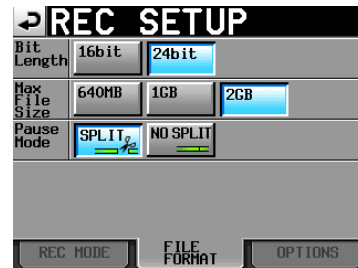

On the **FILE FORMAT** page, set bit length, maximum file size, and how files are treated when recording is paused. The background color for an active setting is light blue.

For details, see “FILE FORMAT page” on page 101.

Other recording settings

Touch the **OPTIONS** tab of the **REC SETUP** screen to open the following screen.



On the **OPTIONS** page, you can change the pre-recording time and auto marker settings. For details, see “OPTIONS page” on page 101.

Setting input monitoring

Turn input monitoring OFF during playback. If input monitoring is ON, input signals will be output through all output connectors.

1. Touch the **INPUT MONITOR** button on the Home Screen to open a pull-up with the input monitoring ON/OFF button.



2. If input monitoring is ON (button appears blue), touch the OFF button to turn it OFF (button appears blue).

Online function settings

Refer to "Online function" on page 129 to make online output settings.

Locate to the playback start position

Use the **◀◀ [◀◀◀]** and **▶▶ [▶▶▶]** keys, jump to a mark or use the manual locate function to locate to the time where you want to start playback.

When timecode synchronization is ON, playback will occur at the input timecode, so locating as described above is not necessary.

Playback control in timeline mode

Press the **PLAY** key to start playback.

Press the **PAUSE** key to pause playback.

Press the **PLAY** key again to resume playback.

Press the **STOP [RETAKE]** key to stop playback.

Press the **◀◀ [MARK ◀◀◀]** key or **▶▶ [MARK ▶▶▶]** key to skip to the start of another region.

Press and hold the **◀◀ [◀◀◀]** or **▶▶ [▶▶▶]** key to search backward or forward.

Press the **◀◀ [MARK ◀◀◀]** key or **▶▶ [MARK ▶▶▶]** key while pressing and holding the **SHIFT** key to move between marks.

Press and hold the **◀◀ [◀◀◀]** or **▶▶ [▶▶▶]** key while pressing and holding the **SHIFT** key to search at high-speed.

While pressing and holding the **STOP** key, press the **◀◀ [MARK ◀◀◀]** key or **▶▶ [MARK ▶▶▶]** key to skip to the beginning of the first region recorded or the end of the last region. (This only works with the front panel keys.)

NOTE

Playback functions can also be performed using a remote control connected through the parallel connector.

Using the call function

Press the **CALL [CHASE]** key to locate to the point where playback was last started from playback standby (call point) and put the unit in playback standby mode.

BWF-J cue point (timeline mode)

When the Follow BWF-J item is set to ON, if a BWF-J cue point is detected during playback, the following corresponding operation will occur. In addition, if the BWF-J Tally Out item is set to ON, in response to each BWF-J cue point, the CUE signal and tally signal will be output from the parallel connector. However, when playback is synchronized with timecode, only the cue and tally signals will be output and the following operations will not occur.

BC\$STANDBY	When a session is loaded, the transport locates to the first BC\$STANDBY point that occurs and pauses. During playback, playback pauses when this cue point is detected. In either case, a BC\$STANDBY tally is output.
BC\$CM	During playback, when this cue point is detected, a BC\$CM CUE signal is output.
BC\$END	During playback, when this cue point is detected, a BC\$END CUE signal is output.
BC\$STOP	During playback, when this cue point is detected, a BC\$STOP CUE signal is output, and playback stops.
BC\$FILE	During playback, when this cue point is detected, a BC\$END CUE signal is output.
BC\$PAUSE	During playback, when this cue point is detected, a BC\$PAUSE tally is output, and playback pauses.

7 – Timeline mode

Loading, saving and creating AES31 editing information

Loading AES31 editing information

You can load AES31 editing information in the current session to the timeline.

When viewed on a computer, the directory of the card should be as follows.

```
{drive name of the card}:\{project name}\{session name}\{AES31 editing information}
```

NOTE

- You cannot load an AES31 editing information file from a folder other than that of the current session.
- Because the AES31 file standard does not support 176.4kHz or 192kHz sampling frequencies, editing information for projects created using these sample rates will be saved using a TASCAM original format, based on AES31. This format might not be compatible with other products.

1. Press the **PROJECT** key to open the **PROJECT** screen.

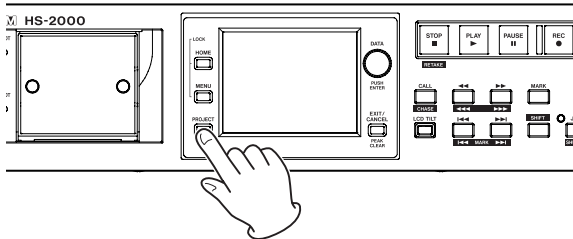

- Touch the → button next to the project that contains the session with the AES31 editing information that you want to load to open the session selection screen. If the selected project is not the current project, a pop-up window appears confirming that you want to load it. Touch the **OK** button.
- Touch the → button for the session with the AES31 editing information that you want to load to open the session selection screen. If it is not the current session, a pop-up window appears confirming that you want to load it. Touch the **OK** button. If AES31 editing data files are found in the session, they appear in the list.



TIP

- After touching a filename area to select a file, touch the **INFO** button to show the date and time it was last changed and its file size.
 - The icon for the currently loaded AES31 file has a "C" in it and appears yellow ().
- Press the → button next to the AES31 editing information that you want to load.
 - When a confirmation pop-up appears, touch the **OK** button or press the **DATA** dial.

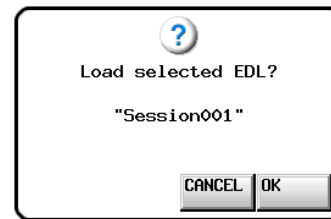

When AES31 editing information is loading, a progress status pop-up appears. When loading completes, the pop-up window disappears and the Home Screen reappears. The loaded information is now used by the timeline.

Saving AES31 editing information

You can save the current timeline as an AES31 file. The saved file is created in the current session folder.

CAUTION

When you edit the timeline, save the AES31 editing information where necessary. If you do not save it, changes will be lost if other AES31 editing information is loaded, the card is removed, or the unit is turned off. If you have not saved the information after editing, a "*" mark will be shown on the AES31 file name display button.

When a "*" is shown, if you load other AES31 editing information, create new AES31 editing information, or change the operation mode, for example, a pop-up message asking if you want to save the current AES31 editing information will appear.

1. Press the **HOME** key on the front panel to open the Home Screen.
2. Touch the AES31 file name display button on the Home Screen to open a pull-down menu.



3. When you touch the **SAVE** button on the pull-down menu, the information will be saved on the selected card. While saving, a progress status pop-up appears. When saving is complete, the pop-up window will disappear.



Naming and saving AES31 editing information

You can name and save the current timeline as an AES31 file. The created file is saved in the current session folder.

1. Press the **HOME** key on the front panel to open the Home Screen.
2. Touch the AES31 file name display button on the Home Screen to open a pull-down menu.



3. Touch the **SAVE AS** button in the pull-up menu to open the **AES31 NAME** screen where you can input the AES31 data file name.



Input the file name. Follow the procedures in "Editing project names" on page 40.

7 – Timeline mode

4. Touch the **Enter** button on the **AES31 NAME** screen or press the **DATA** dial to save the data with the input name.

While saving, a progress status pop-up appears. When saving is complete, the pop-up window will disappear.



NOTE

If a file with the same name already exists, a pop-up window opens to confirm that you want to overwrite the existing file. Touch the **OK** button to overwrite existing file, or touch the **CANCEL** button to return to the **AES31 NAME** screen.



Creating new AES31 editing information

You can create a new AES31 file in the current session (loaded session).

1. Press the **HOME** key on the front panel to open the Home Screen.
2. Touch the AES31 file name display button on the Home Screen to open a pull-down menu.



3. Touch the **CREATE AES31** button on the pull-down menu item to open the **AES31 NAME** screen where you can name the AES31 editing data file. Input the file name. Follow the procedures in "Editing project names" on page 40.



NOTE

You can also create a new AES31 file by touching the **CREATE AES31** button on the AES31 file selection screen.

4. Touch the **Enter** button or press the **DATA** dial on the **AES31 NAME** screen.

- When a confirmation pop-up message appears, touch the **OK** button or press the **DATA** dial to create the new AES31 data information file with the input name.



NOTE

If the a file with the same name already exists, a pop-up window warns, "This name already exists." Touch the **CLOSE** button to return to the AES31 NAME screen, and enter another name.



Importing all takes

Importing all takes clears the current timeline, and imports the AES31 editing information of all takes in the current session folder.

Each take is imported to the timeline at the timecode value set for the take. If a timecode value is not set, the take is imported to the beginning of the timeline (00 h 00 m 00 s 00 f).

NOTE

Takes are imported in take list order. If takes overlap, the take added later will be played back in the overlapping regions. If two takes overlap completely, the take closer to the end of the list will be played back.

- Press the **HOME** key on the front panel to open the Home Screen.
- Touch the AES31 file name display button on the Home Screen to open a pull-down menu.



- Touch the **IMPORT ALL TAKES** button on the pull-down menu item.
- A confirmation pop-up will appear.



Touch the **OK** button or press the **DATA** dial to clear the current timeline and import all the takes from the current session folder.

Touch the **CANCEL** button to return to Home Screen.

7 – Timeline mode

Renaming AES31 file names

1. Press the **PROJECT** key on the front panel to open the **PROJECT** screen.
2. Touch the **→** button of the project containing the AES31 file you want to rename to display the session selection screen.



If the selected project is not the current project, a pop-up window appears confirming that you want to load it. Touch the **OK** button.

3. Touch the **→** button of the project containing the AES31 file that you want to rename to open the AES31 file selection screen.



If it is not the current session, a pop-up window appears confirming that you want to load it. Touch the **OK** button.

4. Select the AES31 file that you want to rename. The background of the selected AES31 file will become yellow.



5. Touch the **MENU** button to open a pull-up menu.



6. Touch the **EDIT NAME** button in the pull-up menu to open the **AES31 NAME** screen where you can edit the AES31 file name. Follow the procedures in "Editing project names" on page 40.



NOTE

If the loaded AES31 file is selected, the **EDIT NAME** button on the pull-up menu is disabled.

7. Touch the **Enter** button on the **AES31 NAME** screen or press the **DATA** dial.

NOTE

If the entered file name already exists, a pop-up window warns, "This name already exists." Touch the **CLOSE** button to return to the **AES31 NAME** screen, and enter another name.



Deleting an AES31 file

1. Press the **PROJECT** key on the front panel to open the **PROJECT** screen.
2. Touch the → button of the project containing the AES31 file to be deleted to open the session selection screen.

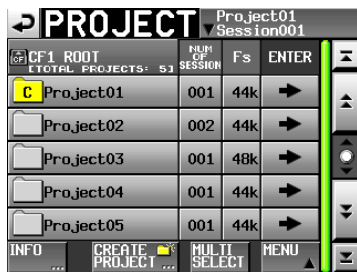

If the selected project is not the current project, a pop-up window appears confirming that you want to load it. Touch the **OK** button.

3. Touch the → button of the project containing the AES31 file to be deleted to open the AES31 file selection screen.



If it is not the current session, a pop-up window appears confirming that you want to load it. Touch the **OK** button.

4. Select the AES31 file that you want to delete. The background of the selected AES31 file becomes yellow.



5. Touch the **MENU** button to open a pull-up menu.



6. Touch the **DELETE** button in the pull-up menu.

NOTE

If the loaded AES31 file is selected, the **DELETE** button on the pull-up menu is disabled

7. Touch the **OK** button or press the **DATA** dial when the confirmation pop-up appears. When deleting is complete, the pop-up window will disappear.



7 – Timeline mode

Timeline editing

You can cut, erase and divide regions. The basic editing procedures are as follows. For details about each operation, see its explanation.

NOTE

Editing in timeline mode is non-destructive. When you edit regions, the original audio files are preserved.

1. Press the **HOME** key on the front panel to open the Home Screen.

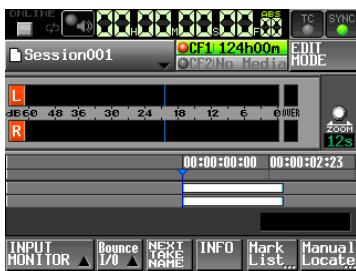

2. Touch the **EDIT MODE** button to enter edit mode. The **EDIT MODE** button becomes white with red lettering, and the **REC/MON**, **Bounce I/O** and **NEXT TAKE NAME** buttons are replaced with **EDIT**, **Fade/Level** and **SET/SELECT** buttons, as shown below.

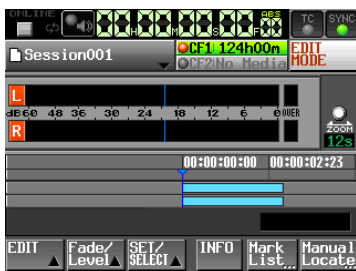

3. Touch the **EDIT** button to open a pull-up menu.



The pull-up menu includes nine editing function buttons (**Copy**, **Cut**, **Erase**, **Divide**, **Insert**, **Insert File**, **Insert Mute**, **Paste** and **Paste File**) and **UNDO** and **REDO** buttons.

CAUTION

If you do not save AES31 editing information, changes will be lost if another project, session or AES31 editing information file is loaded, the card is removed, or the unit is turned off.

NOTE

Repeated recording and editing can result in a shortage of available system memory, which is necessary to manage regions and editing history. In this case, recording is not possible, and a pop-up message warns “Cannot Edit. System limit reached.”

Selecting the range to copy/cut/delete

- If editing start (IN) and end (OUT) points are set, the range between the points is selected (see below).
- If editing start and end points are not set, the entire region under the time cursor is selected.

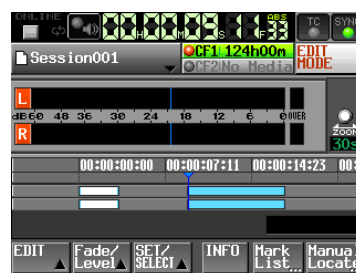

Editing start and end points not set

- When the timeline cursor is on a borderline between regions, the region to the right of the cursor will be edited unless it is muted, in which case nothing will be selected.

Setting the editing start (IN) point

1. Press the **HOME** key on the front panel to open the Home Screen.
2. Touch the **EDIT MODE** button to enter the edit mode.
3. Use the **◀◀/▶▶** keys (or other controls) to locate the timeline cursor to the position (time) where you want editing to start.
4. Touch the **SET/SELECT** button to open a pull-up menu.



5. Touch the **SET IN** button in the pull-up menu to set the editing start (IN) point. The IN mark (📌) will appear in the mark display area at the current position.

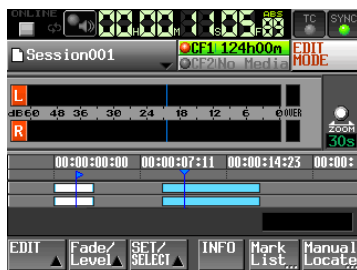

Setting the editing end (OUT) point

6. Use the **◀◀/▶▶** keys (or other controls) to locate the timeline cursor to the position (time) where you want editing to end.
7. Touch the **SET/SELECT** button to open a pull-up menu.
8. Touch the **SET OUT** button in the pull-up menu to set the editing end (OUT) point. The OUT mark (📌) will appear in the mark display area at the current position.



The interval shown in light blue between the IN (📌) and OUT (📌) marks will be affected by editing operations.

Clearing the start and end (OUT) points

1. Touch the **SET/SELECT** button to open a pull-up menu.



2. Touch the **CLEAR** button in the pull-up menu. When a confirmation pop-up appears, touch the **OK** button or press the **DATA** dial. The current IN and OUT points are removed, and the IN (📌) and OUT (📌) marks disappear.

7 – Timeline mode

Selecting a complete region for editing

1. Press the **HOME** key on the front panel to open the Home Screen.
2. Touch the **EDIT MODE** button to enter the edit mode.

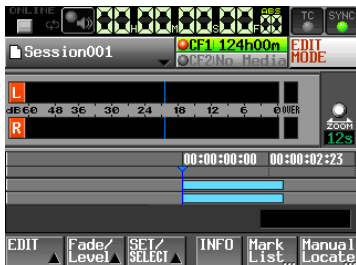

3. Move the timeline cursor to the region to be edited.
4. Touch the **SET/SELECT** button to open a pull-up menu.



5. When you touch the **SELECT Region** button in the pull-up menu, the entire region below the timeline cursor is selected and the beginning of that region is set as the editing start (IN) point and its end is set as the end (OUT) point.



The interval shown in light blue between the IN () and OUT () marks (the selected region) will be affected by editing operations.

Copying the data of the selected area (Copy)

You can copy the selected area.

NOTE

- Copied data is retained in the copy buffer.
- If an entire fade (in/out) area is included, the fade information is also be retained.

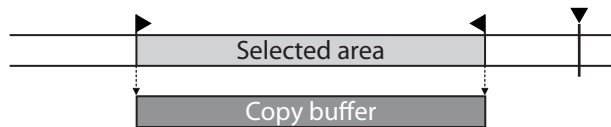

1. Press the **HOME** key on the front panel to open the Home Screen.
2. Touch the **EDIT MODE** button to enter the edit mode.
3. Move the timeline cursor to the area to copy.
4. Touch the **SET/SELECT** button and select the region you want to copy using the **SET IN** and **SET OUT** or **SELECT Region** buttons in the pull-up menu.

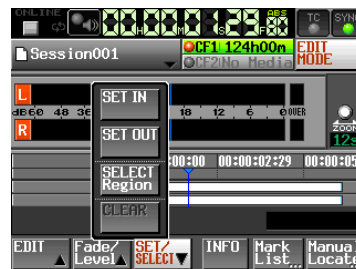

5. Touch the **EDIT** button to open a pull-up menu.



6. Touch the **COPY** button in the pull-up menu. When copying is complete, a pop-up window will appear momentarily, and then the Home Screen will reopen.



In this case, the **EDIT** pull-up menu will remain open.

Cutting the data in a selected area (Cut)

You can cut the data in a selected region. This copies it to the copy buffer. The newly emptied area is then filled by moving the session data after the OUT point of the cut data forward to where its IN point was.

NOTE

- Cut data will be retained in the copy buffer.
- If an entire fade (in/out) area is included, the fade information will also be retained.
- If an IN or OUT point is within a region, any part of the region outside of the cut area will become a new region.
- When the IN point or OUT point is within a fade in/out area, the fade information will be deleted.

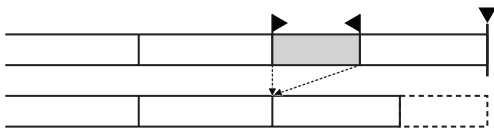

1. Press the **HOME** key on the front panel to open the Home Screen.
2. Touch the **EDIT MODE** button to enter the edit mode.
3. Move the timeline cursor to the area to be cut.
4. Touch the **SET/SELECT** button and set the area you want to cut using the **SET IN** and **SET OUT** or **SELECT Region** buttons in the pull-up menu.



5. Touch the **EDIT** button to open a pull-up menu.



6. Touch the **Cut** button in the pull-up menu. When cutting is complete, a pop-up window will appear momentarily, and then the Home Screen will reopen.

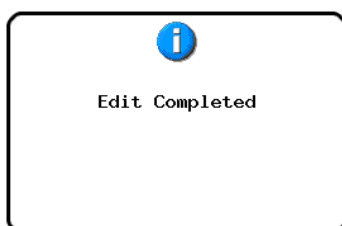

In this case, the EDIT pull-up menu will remain open.

Erasing the data in the selected area (Erase)

You can erase a selected region to make it silent. The positions of any regions after the erased area will remain unchanged.

NOTE

- Erased data will be retained in the copy buffer.
- If an entire fade (in/out) area is included, the fade information will also be retained in the copy buffer.
- When an IN or OUT point is within a region, any part of the region outside of the area erased will become a new region.
- When the IN point or OUT point is set in a fade in/out area, the fade information will be erased.

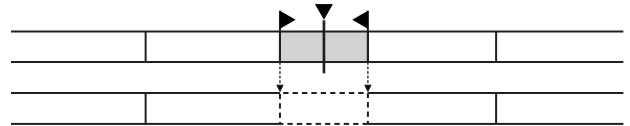

1. Press the **HOME** key on the front panel to open the Home Screen.
2. Touch the **EDIT MODE** button to enter the edit mode.
3. Move the timeline cursor to the area to be erased.
4. Touch the **SET/SELECT** button and set the area you want to erase using the **SET IN** and **SET OUT** or **SELECT Region** buttons in the pull-up menu.



5. Touch the **EDIT** button to open a pull-up menu.



7 – Timeline mode

- Touch the **Erase** button in the pull-up menu. When erasing is complete, a pop-up window will appear momentarily, and then the Home Screen will reopen.



In this case, the EDIT pull-up menu will remain open.

Dividing regions at a specified position (Divide)

You can divide a selected region into two regions at the position of the timeline cursor.

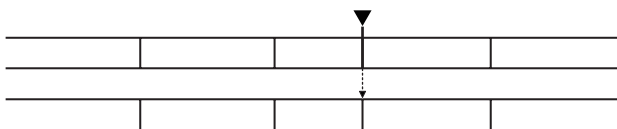

- Press the **HOME** key on the front panel to open the Home Screen.
- Touch the **EDIT MODE** button to enter the edit mode.
- Move the timeline cursor to the point where you want to divide the region.
- Touch the **EDIT** button to open a pull-up menu.



- Touch the **Divide** button in the pull-up menu. When dividing is complete, a pop-up window will appear momentarily, and then the Home Screen will reopen.

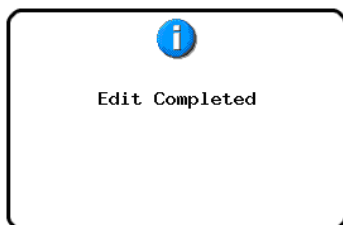

In this case, the EDIT pull-up menu will remain open.

Inserting copy buffer data at a set position (Insert)

NOTE

All regions after the inserted position will move backward along the timeline by the amount of time of the inserted data.

- Inserting into a region creates three regions: a region before the timeline cursor, the contents of the copy buffer, and a region after the timeline cursor.
- If the insertion position is within a fade in/out, the fade information will be deleted.

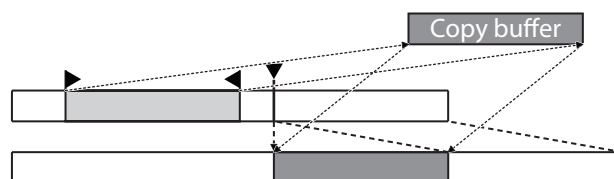

- Press the **HOME** key on the front panel to open the Home Screen.
- Touch the **EDIT MODE** button to enter the edit mode.
- Move the timeline cursor to the position where you want to insert the data.
- Touch the **EDIT** button to open a pull-up menu.



Touch the **Insert** button in the pull-up menu.

NOTE

The **Insert** button is available only when the copy buffer contains data.

- When insertion is complete, a pop-up window will appear momentarily, and then the Home Screen will reopen.



In this case, the EDIT pull-up menu will remain open.

Inserting a file at a set position (Insert File)

You can insert an entire 2-channel BWF/WAV file into a set position.

The file does not have to be in the same project, or even on the same media, but it must be at the same sampling frequency as the project.

NOTE

- All regions after the inserted position will move backward along the timeline by the amount of time of the inserted data.
- Inserting into a region creates three regions: a region before the timeline cursor, the contents of the copy buffer, and a region after the timeline cursor.
- If the insertion position is within a fade in/out, that fade information will be deleted.

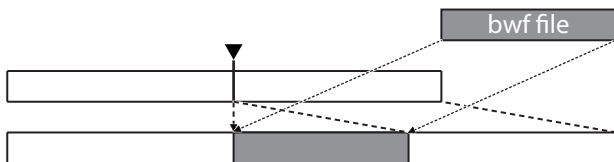

1. Press the **HOME** key on the front panel to open the Home Screen.
2. Touch the **EDIT MODE** button to enter the edit mode.
3. Move the timeline cursor to the position where you want to insert the file.
4. Touch the **EDIT** button to open a pull-up menu.

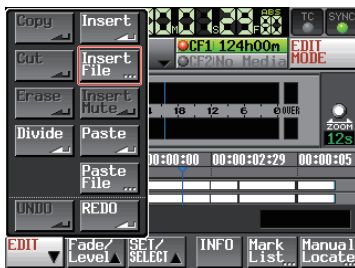

Touch the **Insert File** button in the pull-up menu to open the **BROWSE** screen.

5. On the **BROWSE** screen, touch the **→** button to select the media containing the file to insert.

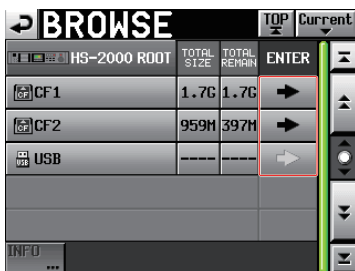

NOTE

If the top page of the **BROWSE** screen is not displayed, touch **TOP** at the top of the screen to open the media selection screen.

6. After selecting a file to insert on the **BROWSE** screen, touch the **Insert File** button.



7. When the **Select Insert Position** pop-up window appears, touch either the **Current Position** or **File T/C** button to start inserting.



You can also touch the **CANCEL** button to return to the **BROWSE** screen.

NOTE

- If the **File T/C** button is touched, but the selected file contains no timecode information, the file will be inserted at the beginning (00 h 00 m 00 s 00 f).
- If you select a file from other than the current session folder, the file is copied to the current folder and then inserted.
- If a file with the same name already exists in the current session folder, "Cannot Copy for Insert" appears in a pop-up window. In this case, you can touch the **RENAME** button to change the name of the file before inserting. You can also touch the **CANCEL** button to cancel insertion.



8. When insertion is complete, a pop-up window will appear momentarily, and then the Home Screen will reopen. In this case, the **EDIT** pull-up menu will be closed.



7 – Timeline mode

Inserting silence into a set area (Insert Mute)

You can insert silence into a designated area.

NOTE

- All regions following the IN point will be moved backward.
- All regions after the IN position will move backward along the timeline by the amount of time of the inserted data.
- Inserting into a region creates two regions: a region before the timeline cursor and a region after the timeline cursor
- When the IN point is set in a fade in/out area, that fade information will be deleted

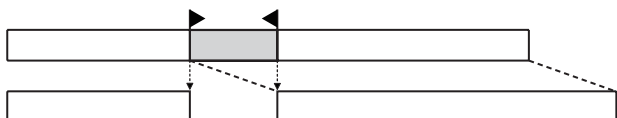

1. Press the **HOME** key on the front panel to open the Home Screen.
2. Touch the **EDIT MODE** button to enter the edit mode.
3. Touch the **SET/SELECT** button and set the area you want to insert silence using the **SET IN** and **SET OUT** or **SELECT Region** buttons in the pull-up menu.



4. Touch the **EDIT** button to open a pull-up menu.



5. Touch the **Insert Mute** button in the pull-up menu to insert silence. When completed, a pop-up window will appear momentarily, and then the Home Screen will reopen.



In this case, the EDIT pull-up menu will remain open.

Pasting copy buffer data into the set position (Paste)

You can paste copied data into a set position.

NOTE

When the area pasted into is set in a fade in/out area, the fade information will be deleted.

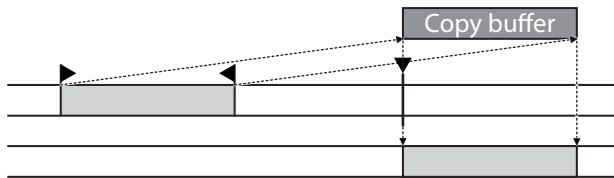

1. Press the **HOME** key on the front panel to open the Home Screen.
2. Touch the **EDIT MODE** button to enter the edit mode.
3. Move the timeline cursor to the position where you want to paste the copy buffer.
4. Touch the **EDIT** button to open a pull-up menu.



Touch the Paste button in the pull-up menu.

NOTE

The Paste button appears white and is available only when the copy buffer contains data.

5. When pasting is complete, a pop-up window will appear momentarily, and then the Home Screen will reopen.



In this case, the EDIT pull-up menu will remain open.

Pasting a file at a set position (Paste File)

You can paste an entire 2-channel BWF/WAV file into a set position.

The file does not have to be in the same project, or even on the same media, but it must be at the same sampling frequency as the project.

NOTE

When the area pasted into is in a fade in/out area, the fade information will be deleted.

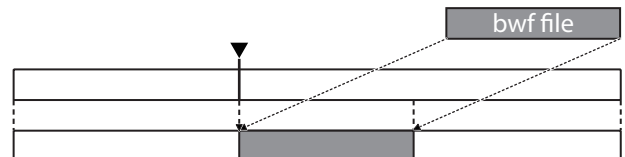

1. Press the **HOME** key on the front panel to open the Home Screen.
2. Touch the **EDIT MODE** button to enter the edit mode.
3. Move the timeline cursor to the position where you want to paste the file.
4. Touch the **EDIT** button to open a pull-up menu.



Touch the Paste File button in the pull-up menu to open the BROWSE screen

5. On the BROWSE screen, touch the → button to select the media containing the file to paste.

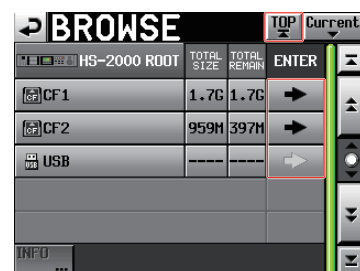

NOTE

If the top page of the BROWSE screen is not displayed, touch **TOP** at the top of the screen to open the media selection screen.

7 – Timeline mode

- After selecting a file to paste on the **BROWSE** screen, touch the **Paste File** button



- When the **Select Paste Position** pop-up window appears, touch either the **Current Position** or **File T/C** button to start inserting.



You can also touch the **CANCEL** button to return to the **BROWSE** screen.

NOTE

- If the **File T/C** button is touched, but the selected file contains no timecode information, the file will be pasted at the beginning (00 h 00 m 00 s 00 f).
- If you select a file from other than the current session folder, the file is copied to the current folder and then pasted.
- If a file with the same name already exists in the current session folder, "Cannot Copy for Paste" appears in a pop-up window. In this case, you can touch the **RENAME** button to change the name of the file before pasting. You can also touch the **CANCEL** button to cancel pasting.



- When pasting is complete, a pop-up window will appear momentarily, and then the Home Screen will reopen. In this case, the **EDIT** pull-up menu will be closed.

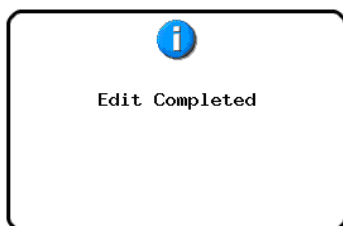

Setting Fades for regions (Fade IN/ FadeOut)

You can set the lengths of region fade-ins and fade-outs as you like. These linear fades are non-destructive (they only affect playback, not the actual data stored).

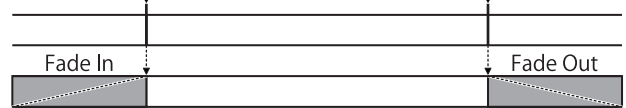

NOTE

- Fade-in/out areas are indicated in light blue.
 - The fade-in lasts from the beginning of the region until the set point.
 - The fade-out lasts from the set point until the end of the region.
- Press the **HOME** key on the front panel to open the Home Screen.
 - Touch the **EDIT MODE** button to enter the edit mode.
 - In the region where you want to set a fade-in or fade-out, move the timeline cursor to the end of fade-in or the beginning of fade out.
 - Touch the **Fade/Level** button to open a pull-up menu.



- To set a fade-in, touch the **Fade IN** button.
 - To set a fade-out, touch the **Fade Out** button.
- After the fade-in/out is set, a pop-up window will appear momentarily, and then the Home Screen will reopen.



In this case, the **Fade/Level** pull-up menu will remain open.

Removing fades (Remove Fade IN/ Remove FadeOut)

1. Press the **HOME** key on the front panel to open the Home Screen.
2. Touch the **EDIT MODE** button to enter the edit mode.
3. Move the timeline cursor to the region with the fade-in/out that you want to remove.
4. Touch the **Fade/Level** button to open a pull-up menu.



- To remove a fade-in, touch the **Remove Fade IN** button.
 - To remove a fade-out, touch the **Remove Fade Out** button.
5. When fade removal is complete, a pop-up window will appear momentarily, and then the Home Screen will reopen.

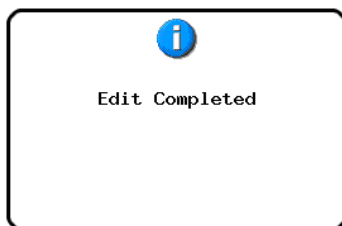

In this case, the **Fade/Level** pull-up menu will remain open.

Setting the playback level of a region (Level)

You can set the playback level for an entire region (from after the fade-in to before the fade-out). If no fades have been set, the whole region is affected. This setting only affects playback, not the actual data.

1. Press the **HOME** key on the front panel to open the Home Screen.
2. Touch the **EDIT MODE** button to enter the edit mode.
3. Move the timeline cursor to the region where you want to set the playback level.
4. Touch the **Fade/Level** button to open a pull-up menu.



5. Touch the **Level** button in the pull-up menu. The yellow region under the timeline cursor will be the subject of Level adjustment.



6. A level knob appears above the **Level** button. Use the **DATA** dial to set playback level.

Setting range

$-\infty$, -120 dB to +10.0 dB

7. Touch the **Level** button again to hide the level knob. (The playback level setting will be retained.)

7 – Timeline mode

Undoing the previous edit (UNDO)

You can undo the previous timeline edit.

1. Press the **HOME** key on the front panel to open the Home Screen.
2. Touch the **EDIT MODE** button to enter the edit mode.
3. Touch the **EDIT** button to open a pull-up menu.



4. Touch the **UNDO** button in the pull-up menu. After the edit is undone, a pop-up window will appear momentarily, and then the Home Screen will reopen.

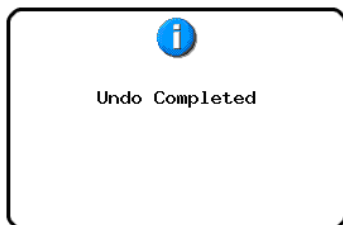

In this case, the **EDIT** pull-up menu will remain open.

NOTE

- The Fade/Level pull-up menu also has an **UNDO** button that can be used to undo edits.
- The **UNDO** button appears with white letters when it is possible to undo an edit. The **UNDO** button is disabled if no editing has been conducted.
- In timeline mode, up to 10 of the most recent recording/editing operations can be retained as an editing history. You can undo and redo edits within this history. However, as the numbers of edits and regions increase, the number of operations that can be stored may decrease.
- The timeline mode editing history will be cleared by the following actions:
 - Turning off the power of this unit
 - Loading a project or session
 - Loading AES31 edit information
 - Changing the operation mode

Redoing an edit (REDO)

After undoing an edit, you can redo it.

1. Press the **HOME** key on the front panel to open the Home Screen.
2. Touch the **EDIT MODE** button to enter the edit mode.
3. Touch the **EDIT** button to open a pull-up menu.



4. Touch the **REDO** button in the pull-up menu. After the edit is redone, a pop-up window will appear momentarily, and then the Home Screen will reopen.

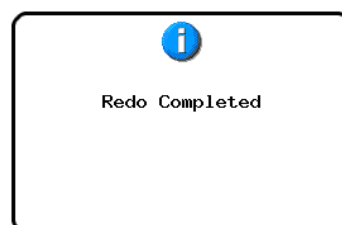

In this case, the **EDIT** pull-up menu will remain open.

NOTE

- The Fade/Level pull-up menu also has an **REDO** button that can be used to redo edits.
- If no edit has been undone, the **REDO** button is disabled. The **REDO** button appears with white letters when it is possible to redo an edit.
- In timeline mode, up to 10 of the most recent recording/editing operations can be retained as an editing history. You can undo and redo edits within this history. However, as the numbers of edits and regions increase, the number of operations that can be stored may decrease.
- The timeline mode edit history will be cleared by the following actions:
 - Turning off the power of this unit
 - Loading a project or session
 - Loading AES31 edit information
 - Changing the operation mode

Bouncing

You can save part of a region or an interval that crosses multiple regions as a single take.

Setting the bounce starting point

1. Touch the **HOME** key to open the Home Screen.
2. Use the **◀** and **▶** keys (or other controls) to locate the timeline cursor to the bounce starting point (time).
3. Touch the **Bounce I/O** button to open a pull-up menu.



4. Touch the **SET IN** button in the pull-up menu to set the bounce starting (IN) point. The IN mark (📌) appears in the mark display area at the current position.



Setting the bounce ending point

5. Use the **◀** and **▶** keys (or other controls) to locate the timeline cursor to the bounce ending point (time).
6. Touch the **Bounce I/O** button to open a pull-up menu.
7. Touch the **SET OUT** button in the pull-up menu to set the bounce ending (OUT) point. The OUT mark (📌) appears in the mark display area at the current position.



The interval shown in light blue between the IN (📌) and OUT (📌) marks will be bounced.

Bouncing the interval

8. Touch the **Bounce I/O** button to open a pull-up menu.
9. Touch the **BOUNCE** button in the pull-up menu to open the **BOUNCE NAME** screen where you can input the name of the file that will be bounced.



Input the file name. Follow the procedures in “Editing project names” on page 40.

10. Touch the **Enter** button. A confirmation message pop-up will appear.



- Touch the **Root dir** button to save the bounced file in the root directory of the current CF card.
- Touch the **Current Session** button to save the bounced file in the current session.
- Touch the **CANCEL** button to return to the **BOUNCE NAME** screen without bouncing.

While the file is being created, a progress status pop-up appears.

When file creation completes, the pop-up disappears.

NOTE

You can cancel a bounce by pressing the **CANCEL** button while the progress pop-up window is open.

Clearing bounce starting and ending points

11. Touch the **Bounce I/O** button to open a pull-up menu.
12. Touch the **CLEAR** button in the pull-up menu. When a confirmation pop-up appears, touch the **OK** button or press the **DATA** dial. The IN and OUT points that had been set will be cleared and the IN (📌) and OUT (📌) marks in the mark display area will disappear.

8 – Take mode

In this chapter, we explain how to use the unit when its operation mode is set to TAKE MODE. (See “Selecting the operation mode” on page 47.)

Please refer to “4–Basic operation” on page 29 when reading this chapter.

Preparing to record

Basic preparations

Refer to “4–Basic operation” on page 29 and make the basic preparations for recording.

Creating a new project

Create new projects as necessary. You do not need to create a new project if you plan to record into an existing one.

1. Press the **PROJECT** key on the front panel to open the **PROJECT** screen.
2. Touch the **CREATE PROJECT** button on the **PROJECT** screen to open the **CREATE PROJECT** screen [1/3].



On this screen, set the project name, the name for the first session the sampling frequency and the sampling frequency written to BWF chunks.

Touch the **NEXT** button to open the next page [2/3].

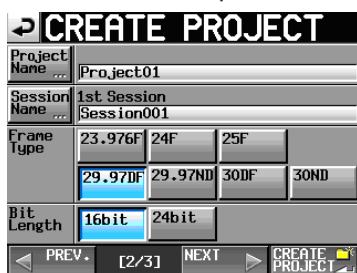

Set the frame type and bit length.

Touch the **NEXT** button to open the next page [3/3].

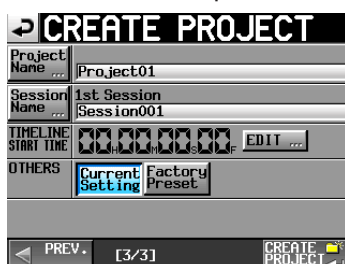

Finally, set the timeline mode starting time, and then set whether other settings should be retained from the currently open project or whether the factory defaults should be used instead.

For further details about these settings, see “Creating a new project” on page 31.

3. After you complete making settings touch the **CREATE PROJECT** button.

NOTE

If a project with the same project name already exists, the **CREATE PROJECT** button appears gray and you will not be able to create a new project. If this happens, change the project name.

4. Touch the **OK** button when the confirmation pop-up message appears.

Creating new sessions

Create new sessions as necessary. You do not need to create a new session if you plan to record into an existing one.

1. Press the **PROJECT** key on the front panel to open the **PROJECT** screen.
2. Touch the **→** button of the project in which you want to create a new session to open its session selection screen.

If the selected project is not the current project, a pop-up window appears confirming that you want to load it. Touch the **OK** button.



3. Touch the **MAKE SESSION** button to open the **MAKE SESSION** screen.



4. Touch the **Session Name** button to open the **SESSION NAME** screen where you can change the session name.



To input the session name follow the same procedures as in “Editing project names” on page 40.

NOTE

You cannot use the “@” symbol at the beginning of a session name.

5. Touch the **Enter** button or press the **DATA** dial to return to the **MAKE SESSION** screen.
6. If necessary, set the timeline start time.
7. When you have finished making settings, touch the **MAKE SESSION** button.
8. When a confirmation pop-up appears, touch the **OK** button or press the **DATA** dial to return to the Home Screen.
For details about session operations, see “Session operations” on page 42.

Recording mode settings

1. Press the **MENU** key on the front panel to open the **MENU** screen.

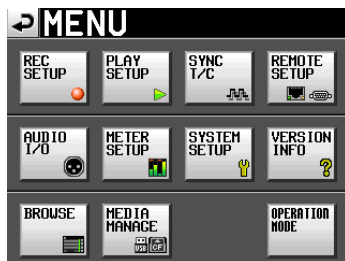
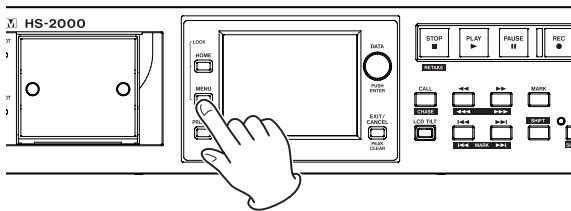

2. Touch the **REC SETUP** button to open the **REC SETUP** screen.

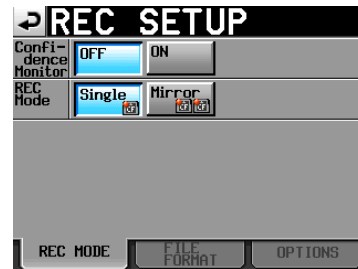

On the **REC MODE** page, you can select the recording mode. The background color for an active setting is light blue. For more details, see “REC MODE page” on page 100.

Setting the file format

Touch the **FILE FORMAT** tab on the **REC SETUP** screen to open the following screen.

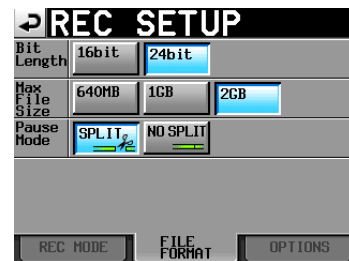

On the **FILE FORMAT** page, set bit-length, maximum file size, and how files are treated when recording is paused. The background color for an active setting is light blue.

For details, see “FILE FORMAT page” on page 101.

Other recording settings

Touch the **OPTIONS** tab of the **REC** open the following screen.

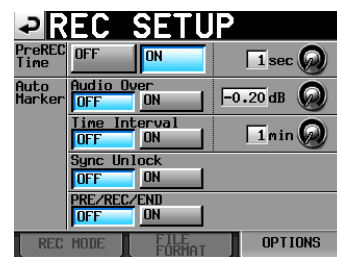

On the **OPTIONS** page, you can change the pre-recording time and auto marker settings. For details, see “OPTIONS page” on page 101.

8 – Take mode

Making a recording

Recording

When the unit is stopped, press the **REC** key to put the unit into recording standby. At this time, the  icon indicates this transport status.

In recording standby, press the **PLAY** key to start recording.

The transport status display at the top left of the Home Screen changes into the recording status display and part of the background of the Home Screen becomes red, indicating that the unit is recording. The time counter starts at the same time.



NOTE

- When stopped, pressing the **PLAY** key while pressing and holding the **REC** key will also start recording.
- Recording can also be controlled using parallel control (except retaking).
- Unlike timeline mode, pressing the **PLAY** key while pressing and holding the **REC** key during playback will not start overwrite recording.
- When in recording standby, the parallel control signals output are high for TALLY_RECORD and low for TALLY_PAUSE.
- When in recording standby, the **REC** and **PAUSE** keys on the front panel will be lit.

Stopping recording

To stop recording, press the **STOP [RETAKE]** key.

Retaking a recording

Press the **STOP [RETAKE]** key while pressing and holding the **SHIFT** key to erase the last recorded take. (The recorded audio file itself will be deleted.)

If you press the **PAUSE** key during recording to record multiple consecutive takes (files) and the PAUSE MODE is set to SPLIT, this will only erase the last take. If it is set to NO SPLIT, the recording is not split into multiple takes, so this will erase the entire recording from start to finish. For details about the PAUSE MODE item see "FILE FORMAT page" on page 101.

Playback in timeline mode

Selecting a project, session and take

1. Press the **PROJECT** key on the front panel to open the PROJECT screen.

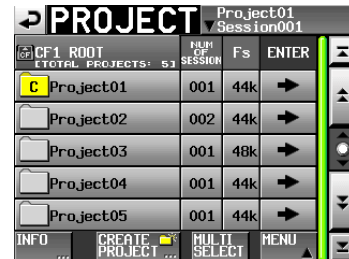

NOTE

You can also touch the session/take name area on the Home Screen to open the PROJECT screen.

2. Touch the **→** button next to the project that contains the take you want to load to open the session selection screen
If the selected project is not the current project, a pop-up window appears confirming that you want to load it. Touch the **OK** button.



3. Touch the **→** button for the session that contains the take you want to load to open the take selection screen.
If it is not the current session, a pop-up appears confirming that you want to load it. Touch the **OK** button.



NOTE

To load a take from the current session, instead of steps 1–4 above, you can also touch the session name button at the top right of the PROJECT screen, or touch the take name button on the Home Screen and touch the TAKE List button in the pull-down menu to open the take selection screen for the current session.

4. Select the take that you want to load.
5. Touch the **MENU** button in the take selection screen to open the pull-up menu.

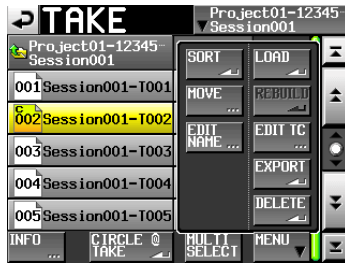

6. Touch the **LOAD** button in the pull-up menu.
7. When a confirmation pop-up appears, touch the **OK** button or press the **DATA** dial.

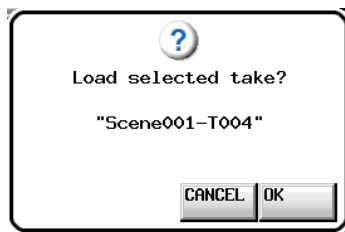

When loading completes, the Home Screen opens.

NOTE

You can also press the **→** button for a take to load it. In this case, no pop-up appears, and the take selection screen remains open after loading (the Home Screen does not reopen).

Online function settings

Refer to “Online function” on page 129 to make online output settings.

Setting input monitoring

Turn input monitoring OFF when you are playing back. If input monitoring is ON, sound from the input connectors will be output through all the output connectors of this unit.

1. Touch the **INPUT MONITOR** button on the Home Screen to open a pull-up with the input monitoring ON/OFF button.

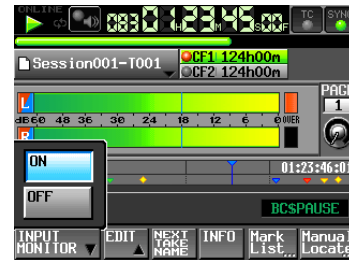

2. If input monitoring is on (**ON** button appears blue), touch the **OFF** button to turn it off (**OFF** button appears blue).

Playback control in take mode

Press the **PLAY** key to start playback.

Press the **PAUSE** key to pause playback.

Press the **PLAY** key again to resume playback.

Press the **STOP [RETAKE]** key to stop playback.

Press the **◀◀ [MARK ◀◀]** key or **▶▶ [MARK ▶▶]** key to skip to the next take.

Press and hold the **◀◀ [◀◀◀]** or **▶▶ [▶▶▶]** key to search backward or forward.

Press the **◀◀ [MARK ◀◀]** or **▶▶ [MARK ▶▶]** key while pressing and holding the **SHIFT** key to move between marks.

Press and hold the **◀◀ [◀◀◀]** or **▶▶ [▶▶▶]** key while pressing and holding the **SHIFT** key to search at high-speed.

NOTE

- On the **PLAY SETUP** screen, you can set whether only the currently selected take is played or whether all the takes within the current session are played. You can also enable and disable repeat playback. (See “Playback settings (PLAY SETUP)” on page 102.)
- Playback functions can also be performed using a remote control connected through the parallel connector.

Using the call function

Press the **CALL [CHASE]** key to locate to the point where playback was last started from playback standby (call point) and put the unit in playback standby mode.

8 – Take mode

BWF-J cue point (take mode)

When the Follow BWF-J item is set to ON, if a BWF-J cue point is detected during playback, the following corresponding operation will occur. In addition, if the BWF-J Tally Out item is set to ON, in response to each BWF-J cue point, the cue signal and tally signal will be output from the parallel remote connector.

BC\$STANDBY	When a take is loaded, the transport locates to the first BC\$STANDBY point as the playback start point. During playback, playback pauses when this cue point is detected. In either case, a BC\$STANDBY tally is output.
BC\$CM	During playback, when this cue point is detected, a BC\$CM CUE signal is output.
BC\$END	During playback, when this cue point is detected, a BC\$END CUE signal is output.
BC\$STOP	During playback, when this cue point is detected, a BC\$STOP CUE signal is output, and playback stops.
BC\$FILE	During playback, when this cue point is detected, a BC\$END CUE signal is output. If there is a BC\$STANDBY cue point in the next take, playback will move to it and pause at that point. A BC\$STANDBY tally is output.
BC\$PAUSE	During playback, when this cue point is detected, a BC\$PAUSE tally is output, and playback pauses.

Using the flash start function

Flash start playback is possible using a TASCAM RC-HS32PD or RC-HS20PD (sold separately) or other remote controller.

For details, see “Flash start function” on page 130.

Take operations

Multiple takes can be created in the same session folder. For details about project and session operations, see “5–Projects” on page 35.

The following operations are possible with takes.

- Change take start times
- Export takes
- Delete takes
- Sort takes
- Change the order of takes
- Edit take names
- Divide takes
- Combine takes
- Undo the previous edit
- Redo the cancelled edit

Changing the start time of a take

1. Press the **PROJECT** key on the front panel to open the **PROJECT** screen.
2. Touch the → button for the project that contains the take for which you want to edit the start time to open the session selection screen.
If the selected project is not the current project, a pop-up window appears confirming that you want to load it. Touch the **OK** button.
3. Touch the → button for the session that contains the take for which you want to edit the start time to open the take selection screen.
If it is not the current session, a pop-up window appears confirming that you want to load it. Touch the **OK** button.

NOTE

To load a take from the current session, instead of steps 2–3, touch the session name button at the top right of the project screen, or touch the take name button on the Home Screen, and touch the **TAKE List** button in the pull-down menu to open the take selection screen for the current session.

4. Select the take for which you want to edit the start time.
5. Touch the **MENU** button on the take selection screen to open a pull-up menu.

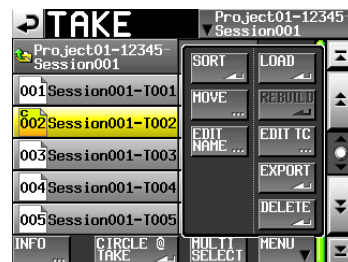

6. Touch the **EDIT TC** button in the pull-up menu to open the **TAKE TC** screen.

- On the TAKE T/C screen, use the FRAME EDIT button to set whether or not to edit the frame value.

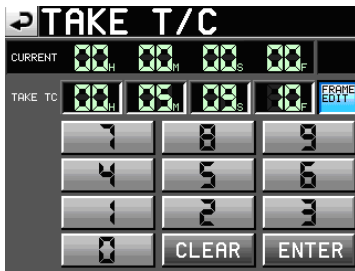

Frame editing on

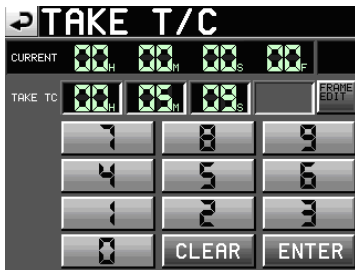

Frame editing off

- Use the number buttons to input the take start time.
 - If you begin input without selecting a unit, input will start from the smallest one.
 - To input a specific unit, touch it to make its background yellow, and then use the number buttons or the DATA dial to enter two digits at a time.
 - Touch the CLEAR button to set all values to 00.
- Touch the ENTER button to confirm the setting.

TIP

- This can also be edited using an external keyboard.
- Press the keyboard's ESC key to clear all values (set them to 00).

- When a confirmation pop-up appears, touch the OK button or press the DATA dial.

Exporting takes

You can export takes from the current session to the following destinations.

- Root of the same CF card
- Root of another CF card
- Current session of another CF card

- Select the take you want to export on the take selection screen.
- Touch the MENU button on the take selection screen to open a pull-up menu.



- Touch the EXPORT button in the pull-up menu to open the following pop-up window. Touch the button for the desired destination to export the take to. Touch the OK button or press the DATA dial to export the selected take. Touch the CANCEL button on the pop-up window to return to the take list screen.

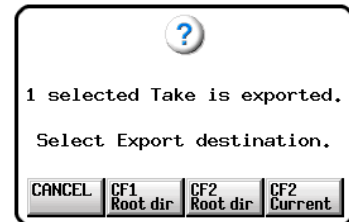

NOTE

- If the export destination is empty (no current session when CFn Current selected) the same project/session structure as the source will be created automatically during the export.
- If the export destination contains a file with the same name, exporting will fail and a pop-up appears warning, "Selected Take Already exists in Export destination."
- If the total size of the export file exceeds the free space of the export destination, exporting will fail and a pop-up appears warning, "Cannot EXPORT. Not enough space on CFn."
- If sampling frequency of the export destination project differs, exporting will fail and a pop-up appears warning, "Cannot EXPORT. Destination Project is different Fs."

8 – Take mode

Deleting a take

1. Select the take that you want to delete on the take selection screen.
2. Touch the **MENU** button on the take selection screen to open a pull-up menu.

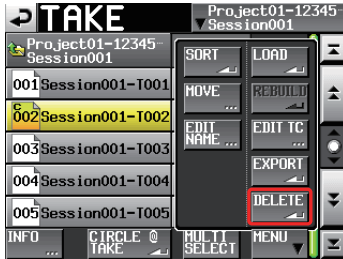

Take selection screen with pull-up menu open

3. Touch the **DELETE** button in the pull-up menu.
4. When a confirmation pop-up appears, touch the **OK** button or press the **DATA** dial.



Confirmation message

5. Touch the **OK** button or press the **DATA** dial again when a second confirmation pop-up message appears.



Second confirmation message

During deletion, a progress status pop-up appears. When deletion completes, the pop-up window will disappear.

CAUTION

You can delete takes that are being used by timeline and playlist modes.

If you delete such a take, an error pop-up will appear if you attempt to play the corresponding region or entry.

Sorting takes

You can sort the playback order of takes by name.

1. Touch the **MENU** button on the take selection screen to open a pull-up menu.



Take selection screen with pull-up menu open

2. Touch the **SORT** button in the pull-up menu to open a confirmation pop-up.



Confirmation message

3. Touch the **OK** button on the pop-up or press the **ENTER** key to sort the order of take playback by name. Touch the **CANCEL** button to return to the take selection screen.

Reordering takes

You can move takes to change the playback order.

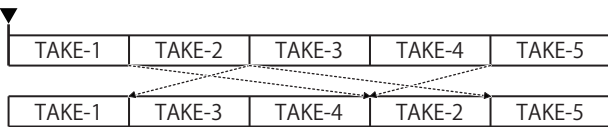

1. Select the take to move on the take selection screen.
2. Touch the **MENU** button on the take selection screen to open a pull-up menu.



Take selection screen with pull-up menu open

3. Touch the **MOVE** button in the pull-up menu to open the TAKE MOVE screen.



4. Use the **DATA** dial and scroll buttons to move the selected take.



5. Touch the **MOVE** button or press the **ENTER** key to move the take to the location shown. Touch the button on the upper left on the screen or press the **EXIT/CANCEL** key to return to the take selection screen without moving the take.

Editing take names

1. Select the take with the name that you want to edit on the take selection screen.
2. Touch the **MENU** button on the take selection screen to open a pull-up menu.



Take selection screen with pull-up menu open

3. Touch the **EDIT NAME** button in the pull-up menu to open the TAKE NAME screen.



TAKE NAME screen

NOTE

When multiple takes are selected, you cannot select the **EDIT NAME** button in the pull-up menu.

4. Edit the take name. See “Editing project names” on page 40 for the input method.
5. Touch the **Enter** button on the TAKE NAME screen or press the **DATA** dial to determine the take name and to return to the take selection screen.

CAUTION

You can change the names of takes that are being used by timeline and playlist modes.

If you change the name of such a take, an error pop-up will appear if you attempt to play the corresponding region or entry.

8 – Take mode

Dividing takes

You can divide a take into two at the point you choose.

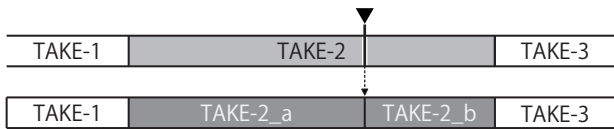

1. Press the **HOME** key on the front panel to open the Home Screen.
2. Move the timeline cursor to the approximate point where you want to divide the take.
3. Touch the **EDIT** button on the Home Screen to open a pull-up menu.



4. Touch the **Divide** button in the pull-up menu.
5. When -- Divide Mode -- is displayed, scrub playback is enabled, and you can use the following operations to find the exact division position.
 - Turn the **JOG/SHUTTLE** dial
 - Press the **◀◀/▶▶** key to move one sample
 - Press the **◀◀[◀◀◀] or ▶▶[▶▶▶]** key while pressing and holding the **SHIFT** key to move one 1 ms
 - Press the **◀◀[MARK◀◀] or ▶▶[MARK▶▶]** key while pressing and holding the **SHIFT** key to move to the next mark



When the division point is determined, touch the **Divide** button at the lower-left of the screen.

To cancel division, touch the **CANCEL** button at the lower left of the screen, or press the **STOP** or **EXIT/CANCEL** key.

If one of the new file names that will be assigned after division already exists, the take cannot be divided, and a pop-up appears, warning, "Cannot Divide."

6. When division completes, a pop-up window will appear momentarily, and then the Home Screen will reopen.



Take names and playback order after division

- Take names are assigned as follows after division:
 - First half : <Take name before division>_a
 - Second half : <Take name before division>_b
- The first half will be followed by the second half in playback order.
- The second half will become the current take.
- Other takes that followed the take before division will follow the second half take.
- The total number of takes increases by one after division.
- If a mark point exists at the division point, it becomes a mark at the beginning of the second half take.

Example of division

Take list before dividing Scene001-T001

Project01 Session001	LENGTH	LOAD
001 Scene001-T001	0h00n20s	▶
002 Scene002-T001	0h00n20s	▶
003 Scene003-T001	0h00n20s	▶

Take list after dividing Scene001-T001

Project01 Session001	LENGTH	LOAD
001 Scene001-T001_a	0h00n03s	▶
002 Scene001-T001_b	0h00n16s	▶
003 Scene002-T001	0h00n20s	▶
004 Scene003-T001	0h00n20s	▶

CAUTION

You can divide takes that are being used by timeline and playlist modes.

If you divide such a take, an error pop-up will appear if you attempt to play the corresponding region or entry.

Combining takes

You can combine two takes into one.

NOTE

You cannot combine takes in the following cases.

- The bit lengths, numbers of channels or sampling frequencies are different
- The file size of the combined takes exceeds the Max File Size shown on the REC SETUP screen FILE FORMAT page
- The open space on the media is less than the file size of the second of the two takes to be combined

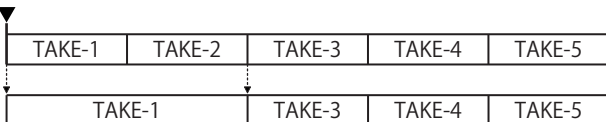

1. Press the **HOME** key on the front panel to open the Home Screen.
2. Select a take as the current take. This will be the first half of the combined take.
3. Touch the **EDIT** button on the Home Screen to open a pull-up menu.



4. Touch the **Combine** button in the pull-up menu.
5. After the take selection screen opens, touch the **→** button of the take to be combined with the current take as the second half.
(The yellow icon indicates the take that was selected in step 3 as the first half of the combined take.)

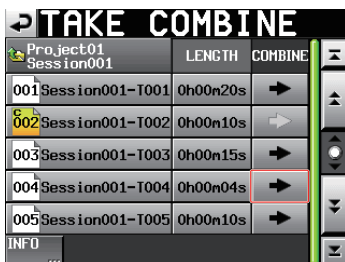

6. A confirmation message appears, and a 4-second loop of before and after the combination point will be played.

Touch the **OK** button or press the **ENTER** key to combine the takes.

Touch the **CANCEL** button or press the **EXIT/CANCEL** key to stop the loop and reopen the take selection screen.

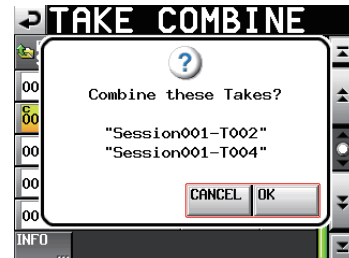

7. While the takes are being combined, a progress status pop-up appears.

When the combination completes, the pop-up window closes and the Home Screen reopens.

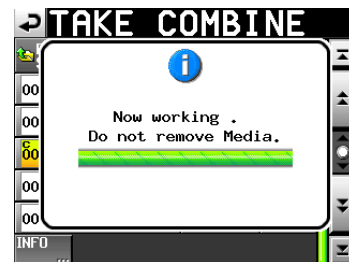

NOTE

- The file name of the first take will be used for the combined take.
- The time code information of the first take will be used for the combined take.
- If the number of mark points for the combined take exceeds 100, all marks after the 100th in order will be lost. These mark points cannot be recovered with **UNDO**.

CAUTION

You can combine takes that are being used by timeline and playlist modes. If you combine such a take, an error pop-up will appear if you attempt to play the corresponding region or entry.

8 – Take mode

Undoing the previous take edit

You can undo the previous take divide or combine operation.

1. Press the **HOME** key on the front panel to open the Home Screen.
2. Touch the **EDIT** button to open a pull-up menu.



3. Touch the **UNDO** button in the pull-up menu. After the edit is undone, a pop-up window will appear momentarily, and then the Home Screen will reopen.



In this case, the **EDIT** pull-up menu will remain open.

NOTE

- If no editing has been conducted, the **UNDO** button is disabled. The **UNDO** button appears with white letters when it is possible to undo an edit.
- The take mode edit history will be erased by the following actions:
 - Turning off the power of this unit
 - Loading a project or session
 - Changing the operation mode
 - Recording

Redoing a take edit

After undoing a take edit, you can redo it, but only once.

1. Press the **HOME** key on the front panel to open the Home Screen.
2. Touch the **EDIT** button to open a pull-up menu.



3. Touch the **REDO** button on the pull-up menu. When the edit is redone, a pop-up window will appear momentarily, and then the Home Screen will reopen.

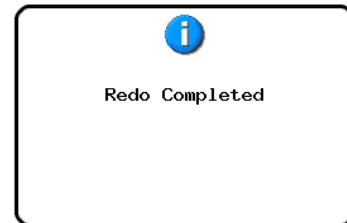

In this case, the **EDIT** pull-up menu will remain open.

NOTE

- If no editing has been conducted, the **UNDO** button is disabled. The **UNDO** button appears with white letters when it is possible to undo an edit.
- The take mode edit history will be erased by the following actions:
 - Turning off the power of this unit
 - Loading a project or session
 - Changing the operation mode
 - Recording

9 – Playlist mode

In this chapter, we explain how to use the unit when it's in playlist mode (See "Selecting the operation mode" on page 47.)

Please refer to "4–Basic operation" on page 29 when reading this chapter.

Playlist operations

Loading projects and sessions

Takes and files can only be added to the playlist from the folder of the currently loaded session. When takes and files from other session folders are added to a playlist, they are first copied to the current session folder. Load the session first.

1. Press the **PROJECT** key on the front panel to open the **PROJECT** screen.

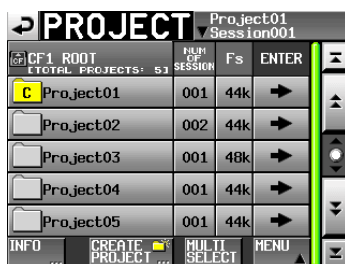
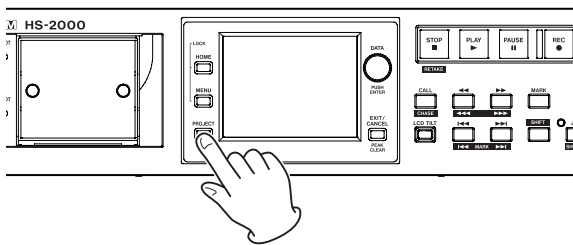

2. Touch the → button next to the project that you want to select to open the session selection screen.
If the selected project is not the current project, a pop-up window appears confirming that you want to load it. Touch the **OK** button.
3. Touch the name of the session to select it.
Its background appears yellow.
4. Touch the **MENU** button on the session selection screen to open a pull-up menu.



5. Touch the **LOAD** button in the pull-up menu.

NOTE

You can also load a session by pressing its → button. In this case, if it is not the current session, a pop-up window appears confirming that you want to load it. Touch the **OK** button.

6. When a confirmation pop-up appears, touch the **OK** button or press the **DATA** dial.



When loading completes, the last loaded playlist (or a playlist created by default for a new session) is automatically loaded and the Home Screen reopens.

9 – Playlist mode

Creating a new playlist

You can create a playlist (JPPA PPL file) in the folder of the current session.

The path when viewing the card on a computer will be as follows:

{Card drive name}:\{Project name}\{Session name}\{playlists}\{Playlist file}

1. Press the **PROJECT** key on the front panel to open the **PROJECT** screen.
2. Touch the → button for the project in which you want to create a new playlist to open the session selection screen.

If the selected project is not the current project, a pop-up window appears confirming that you want to load it. Touch the **OK** button.

3. Touch the → button for the session in which you want to create a new playlist to open the playlist selection screen.

If it is not the current session, a pop-up window appears confirming that you want to load it. Touch the **OK** button.



NOTE

When you create a session, one JPPA PPL file is created automatically.

4. Touch the **CREATE PLAYLIST** button to open the **PLAYLIST NAME** screen.



Enter the playlist name.

To enter the playlist name, follow the procedures in “Editing project names” on page 40.

5. Touch the **Enter** button or press the **DATA** dial.

6. When the confirmation message pop-up appears, touch the **OK** button or press the **DATA** dial to confirm the playlist name.



While the playlist is being created, a progress status pop-up appears. When playlist creation completes, the pop-up will disappear.

NOTE

- Immediately after a new playlist is created, it is loaded as the current playlist.
- You can also create a new playlist can by touching the **CREATE PLAYLIST** button in the pull-down menu that is opened by touching an entry name button on the Home Screen.
- “C” (current) appears inside the 📁 icon of the currently loaded playlist.

Changing playlist names later

You can change playlist names later.

1. Press the **PROJECT** key on the front panel to open the **PROJECT** screen.
2. Touch the → button for the project that contains the playlist for which you want to change the name to open the session selection screen.

If the selected project is not the current project, a pop-up window appears confirming that you want to load it. Touch the **OK** button.

3. Touch the → button for the playlist that contains the session for which you want to change the name to open the playlist selection screen.

If it is not the current session, a pop-up window appears confirming that you want to load it. Touch the **OK** button.

4. Select the playlist that you want to change. The background of the selected playlist name appears yellow.

5. Touch the **MENU** button to open a pull-up menu.



6. Touch the **EDIT NAME** button in the pull-up menu to open the **PLAYLIST NAME** screen.



NOTE

If the loaded playlist is selected, the **EDIT NAME** button in the pull-up menu cannot be selected.

7. Edit the playlist name. Follow the procedures in "Editing project names" on page 40.
8. Touch the **Enter** button on the **PLAYLIST NAME** screen or press the **DATA** dial to confirm the project name and return to the **PLAYLIST** screen.

Loading playlists

You can load a playlist (JPPA PPL file) that is in the folder of the current session.

The path when viewing the card on a computer will be as follows:

{Card drive name}:\{Project name}\{Session name}\[_playlists]\{Playlist file}

NOTE

You cannot load a playlist file that is not in the current session.

1. Press the **PROJECT** key on the front panel to open the **PROJECT** screen.
2. Touch the **→** button for the project that contains the playlist you want to load to open the session selection screen.
If the selected project is not the current project, a pop-up window appears confirming that you want to load it. Touch the **OK** button.
3. Touch the **→** button for the session that contains the playlist you want to load to open the playlist selection screen.
If it is not the current session, a pop-up window appears confirming that you want to load it. Touch the **OK** button.
4. Select the playlist that you want to load.
5. Touch the **MENU** button on the playlist selection screen to open a pull-up menu.



6. Touch the **LOAD** button in the pull-up menu.

NOTE

You can also load a playlist by touching its **→** button.

7. When a confirmation pop-up appears, touch the **OK** button or press the **DATA** dial.



After loading completes, the Home Screen opens.

9 – Playlist mode

Deleting a playlist

1. Press the **PROJECT** key on the front panel to open the **PROJECT** screen.
2. Touch the **→** button for the project that contains the playlist you want to delete to open the session selection screen.
If the selected project is not the current project, a pop-up window appears confirming that you want to load it. Touch the **OK** button.
3. Touch the **→** button for the session that contains the playlist you want to delete to open the playlist selection screen.
If it is not the current session, a pop-up window appears confirming that you want to load it. Touch the **OK** button.
4. Select the playlist that you want to delete.
5. Touch the **MENU** button on the playlist selection screen to open a pull-up menu.

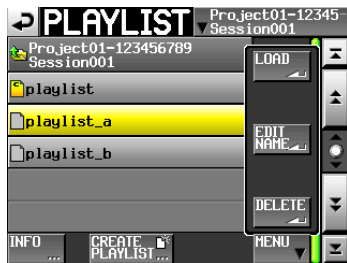

6. Touch the **DELETE** button in the pull-up menu.

NOTE

If you have selected the currently loaded playlist, you cannot use the **DELETE** button on the pull-up menu item.

7. When a confirmation pop-up appears, touch the **OK** button or press the **DATA** dial.



During deletion, a progress status pop-up appears. When deletion completes, the pop-up window will disappear.

Editing playlists (adding, removing and working with entries)

A playback unit in a playlist is called an “entry”.

A maximum of 100 entries can be added to a playlist. Only takes (files) in the session in which the playlist was created can be added as entries.

If a take (file) that is in another session folder of the same project is added to a playlist, it will be copied to the folder of the session where the playlist was made.

Even during playback of a playlist, entries can be added to or removed from it and their names can be changed. The entry that is currently playing, however, cannot be changed.

Use the **ENTRY** list and **ASSIGN** file screens to edit playlists.

ENTRY list screen

To open this screen, touch a take or entry name button on the Home Screen to open a pull-down menu and touch the **ENTRY LIST** button, or touch the **ENTRY** ◀ part of the **ENTRY** ◀ ▶ **ASSIGN** button on the **ASSIGN** file screen.

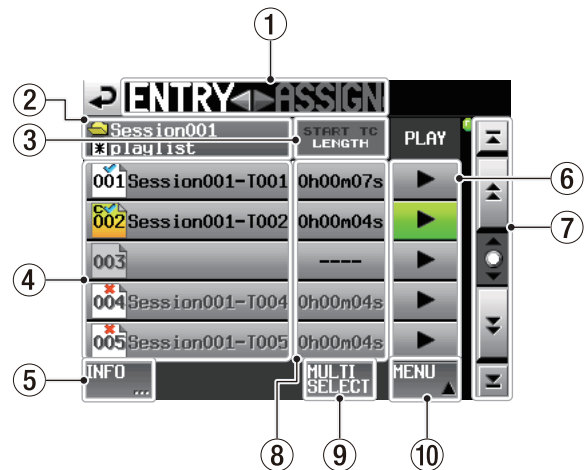

① **ENTRY** ◀ ▶ **ASSIGN** button

Switches between the **ENTRY** list screen and **ASSIGN** file screen.

Touch the ▶ **ASSIGN** part to open the **ASSIGN** file screen.

② **Playlist name display**

The current playlist name is shown.

✳ is displayed if editing has been performed without saving.

③ **START TC/LENGTH** button



Touch this area to switch between showing the starting time (**START TC**) and the length (**LENGTH**) in the **START TC/LENGTH** column. The one shown in white is currently displayed.





④ Entry name button

Touch to select the corresponding entry.
Touch this button to display the take list on the right side.
You can assign a take to this button by touching its take name.



Take list on

The entry number appears inside the  icon.
The status of the entry appears inside the  icon. If the format of the file is different or the file does not exist, its name appears in gray.

	Currently loaded entry
	Entry okay
	Entry in format that cannot be played
	Entry missing because the registered file has been deleted via FTP or on the BROWSE screen
	No entry

⑤ INFO button

When an entry is selected, press this button to open an information pop-up for that entry.
When an entry is not selected, press this button to show information about the current playlist.

⑥ PLAY buttons

Touch to play the corresponding entry.
These turn green during playback of the corresponding entries.
Touch one during playback to stop playback of the corresponding entry.

⑦ Scroll buttons

Use these buttons to scroll to the beginning or end of the entry list, or to scroll one page (five lines) forward or backward. You can also use the **DATA** dial to scroll through the entry list one line at a time.

⑧ START TC/LENGTH display

The entry starting time or entry length (time) is shown. The START TC/LENGTH button item shown in white is currently displayed.

⑨ MULTI SELECT button

Touch to enable the selection of multiple entries.

⑩ MENU button

Touch to open a pull-up menu where you can select REBUILD, CAPTURE BC#, CLEAR, ADJUST, SAVE and SAVE AS.

9 – Playlist mode

ASSIGN file screen

To open this screen, touch a take or entry name button on the Home Screen to open a pull-down menu and touch the **ASSIGN FILE** button, or touch the **▶ ASSIGN** part of the **ENTRY ◀▶ ASSIGN** button on the ASSIGN file screen.

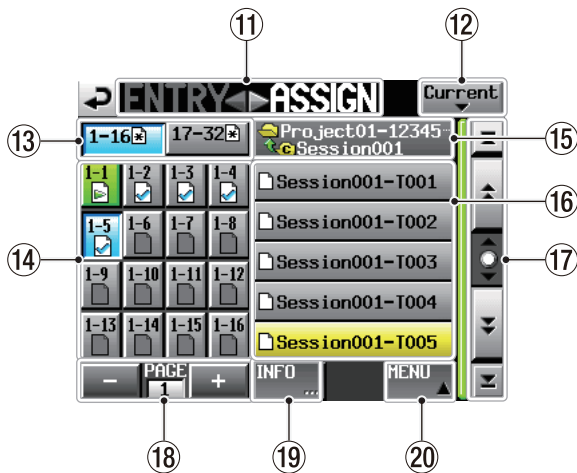

RC-HS32PD connected/remote control not connected

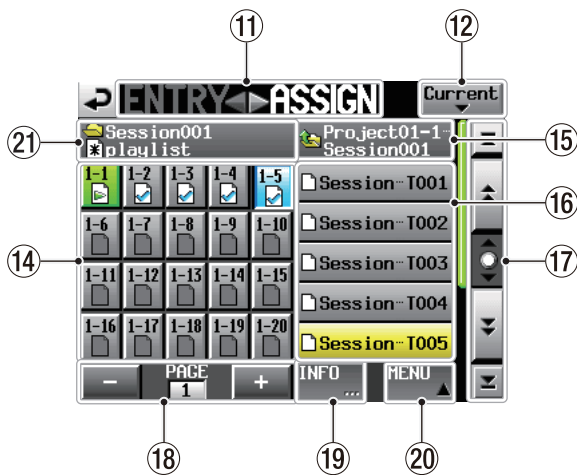

RC-HS20PD connected

- 11 ENTRY ◀▶ ASSIGN button**
Switches between the ENTRY list screen and ASSIGN file screen.
Touch the **ENTRY ◀** part to open the ENTRY list screen.
- 12 Current button**
Touch this button to open the take name list of the current session.
- 13 Key set selection buttons**
Set whether the key assignment buttons for the left or right key set are shown.
When entries have been edited but not saved, appears.
- 14 Key assignment list buttons**
These buttons are for entry assignments.
The flash page number and flash key number are shown separated by a “-”.

The playlist verification status also appears inside the icon.

The icon for the currently playing entry is and its button is highlighted in green.

- Currently playing entry
- Entry okay
- Entry in format that cannot be played
- Entry missing because the registered file has been deleted via FTP or on the BROWSE screen
- No entry

Touch one of these buttons, and then touch a take name to assign that take to that button.

- 15 Current folder button**
This is the name of the folder that is shown in the take list area.
Touch this button to show the session list in the take list area.
- 16 Take/session list buttons**
This list usually shows the takes in the current session.
After touching a key assign button, touch a take name to assign that take to that button.
Touch the current folder button to show the session list for the current project here.
Touch the button of the session that you want to load to open the list of takes in that session.
- 17 Scroll buttons**
Use these buttons to scroll to the beginning or end of the take list or session list, or to scroll one page (five lines) forward or backward. You can also use the **DATA** dial to scroll through the list one line at a time.
- 18 Page display and selection buttons**
The current key assign button page is shown.
Use the + and - buttons to change the page.
- 19 INFO button**
When a key assignment button is selected, press this button to open an information pop-up for that button.
When a take is not selected, press this button to show information about the selected take.
When nothing is selected, touch this button to show information about the current playlist.
- 20 MENU button**
Touch to open a pull-up menu where you can select **REBUILD, CAPTURE BC#, CLEAR, ADJUST, SAVE** and **SAVE AS**.
- 21 Session and playlist name display**
The current session name and playlist name are shown.
When changes have been made but not saved, appears.

NOTE

Explanations hereafter will use the screens shown when an RC-HS32PD connected.

Assigning a take to an entry

1. Press the **HOME** key on the front panel to open the Home Screen.

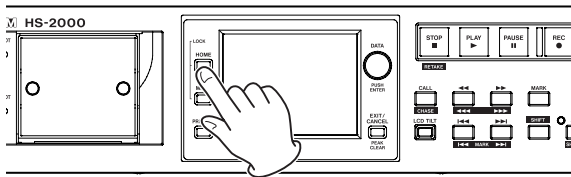

2. Touch the file name or title name button to open a pull-down menu, and touch the **ASSIGN FILE** button to open the ASSIGN file screen where you can assign entries.



On the left side are the buttons that can receive assignments, and on the right side is the list of takes that can be assigned.

3. Use the + and - buttons to open the page where you want to assign the file.
4. Touch the key assignment button that you want to assign a take to in the list on the left. The selected button appears light blue.
5. Touch a take name in the take list to assign that take to that button. When a take is assigned to a button, the button's icon changes from (no assignment) to .
6. Repeat steps 3–6 as necessary.
7. After you have completed making assignments, save the playlist as necessary.

To save a playlist, touch the **MENU** button on the ASSIGN file or ENTRY list screen to open a pull-down menu, and touch the **SAVE** button. You can also save from the Home Screen by touching a file name or title name button to open a pull-down menu and touch the **SAVE** button.

For details about saving, see "Saving playlists" on page 94.

CAUTION

If you do not save the playlist, all changes will be lost when another playlist is loaded, the card is removed or the unit's power is turned off.

NOTE

- If you touch a key assignment button that already has an entry assigned to it, the corresponding take appears yellow in the take list.
- Only takes in the project where the playlist is can be added to the playlist.
- If the take that you want to add does not appear in the list, use the scroll buttons and **DATA** dial to scroll through the list until the take appears and then touch its name.
- If the take that you want to add is in a different session in the same project, touch the current session name button to open the session list. Then, touch the name of the session that contains that take to open that session's take name list.

TIP

- You can also assign takes to entries using the same procedure on the **ENTRY** screen.
- You can also touch the **▶ ASSIGN** button on the **ENTRY** screen to open the **ASSIGN** screen.



Allocation of entries to pages

Playlist entry numbers appear on the pages as follows.

RC-HS32PD connected

Page number	Entry numbers
1	1-32
2	33-64
3	65-96

RC-HS20PD connected

Page number	Entry numbers
1	1-20
2	21-40
3	41-60
4	61-80
5	81-100

9 – Playlist mode

Clearing entry assignments

1. Press the **HOME** key on the front panel to open the Home Screen.
2. Touch the file name or title name and then touch the **ENTRY LIST** button in the pull-down menu to open the **ENTRY** list screen where you can work with entries.



3. Select the entry for which you want to clear the assignment. Its background will become yellow and the take list will be shown on the right side. When you select an entry to which a take has been assigned, the background of the applicable take on the take list will be yellow.
4. Touch the **MENU** button in the **ENTRY** list screen to open a pull-up menu.



5. Touch the **CLEAR** button in the pull-up menu to clear the entry.

NOTE

- You can also clear the selected entry assignment by touching the highlighted take name.
- On the **ASSIGN** file screen, when a button on the left is selected, you can clear its entry by touching the take name that appears yellow in the take list on the right side or by touching the **MENU** button and then touching the **CLEAR** button on the pull-up menu.



Editing entry names

1. Press the **HOME** key on the front panel to open the Home Screen.
2. Touch the file name or title name and then touch the **ADJUST ENTRY** button in the pull-down menu to open the **ADJUST XXX** screen. (“XXX” is the entry number.)

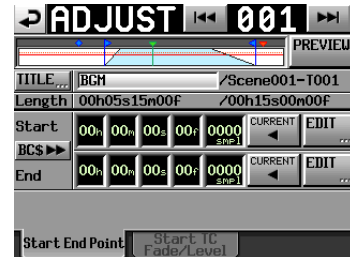

3. The characters shown next to the **TITLE** button is the title of the selected entry. Touch the **TITLE** button to open the **EDIT TITLE** screen where you can change the title of the entry.



Input the title name. Follow the procedures in “Editing project names” on page 40.

4. Touch the **Enter** button on the **EDIT TITLE** screen or press the **DATA** dial to confirm the title change.

NOTE

When a take is selected on the **ENTRY** screen or one of the key assign buttons on the left is selected on the **ASSIGN** file screen, you can also open the **ADJUST** screen by touching the **MENU** button and then touching the **ADJUST** button in the pull-up menu.



ENTRY list screen



ASSIGN file screen

Editing playback starting/ending points

1. Press the **HOME** key on the front panel to open the Home Screen.
2. Touch the file name or title name and then touch the **ADJUST ENTRY** button in the pull-down menu to open the **ADJUST XXX** screen. ("XXX" is the entry number.)

The Start End Point page will be shown automatically.

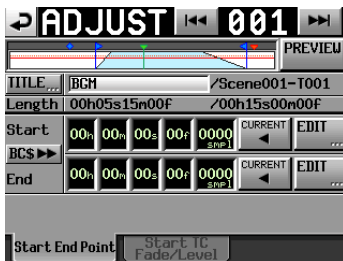

3. When you touch a time display unit, its background will become yellow and the corresponding cursor will start blinking.
After a time display unit has been selected, use the **DATA** dial to change the Start and End points. Changing a selected unit past its maximum (minimum) limit will increase (decrease) the next larger (smaller) unit by one.
4. Select the unit of resolution that you want to change. Select the frame (f) unit to change by frame precision, or select the sample (smpl) unit to change by sample precision.

NOTE

- When a take is selected on the **ENTRY** screen or one of the key assign buttons on the left is selected on the **ASSIGN** file screen, you can also open the **ADJUST** screen by touching the **MENU** button and then touching the **ADJUST** button in the pull-up menu.
- Touch the **CURRENT** button to capture the current playback position as the Start/End point.
- Touch the **BC\$ ►►** button to open pop-up window where you can either set the Start and End point times to the **BC\$STANDBY** and **END** mark times or reset them to the file beginning and end times.
 - Touch the **CAPTURE** button to set the Start and End Point times to the **BC\$STANDBY** and **END** mark times.
 - Touch the **RESET** button reset the Start and End Point times to the file beginning and end times.

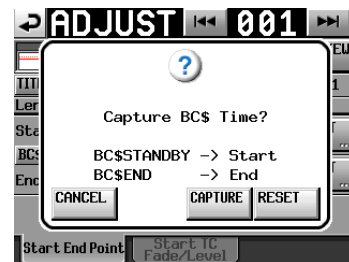

9 – Playlist mode

Setting playback to the BC\$STANDBY/END range

You to change the playback range to the BC\$STANDBY–BC\$END mark interval with one operation.

1. Touch the MENU button on the playlist mode ASSIGN or ENTRY screen to open the pull-up menu.



2. Touch the CAPTURE BC\$ button to open the following pop-up window.

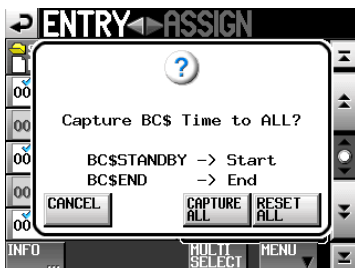

NOTE

Touch the CANCEL button in the pop-up window to return to the ASSIGN or ENTRY screen.

3. Touch the CAPTURE ALL button to open a confirmation pop-up.

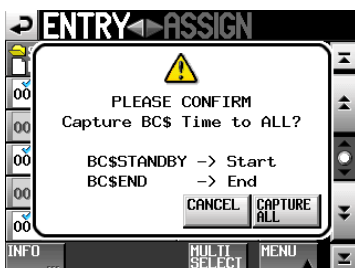

4. In the confirmation pop-up, touch the CAPTURE ALL button to change the playback range to the BC\$STANDBY–BC\$END interval.

NOTE

Touch the CANCEL button in the pop-up window to return to the ASSIGN or ENTRY screen.

5. In the pop-up window that appears after step 1, if you touch the RESET ALL button, the following pop-up window appears.



6. Touch the RESET ALL button in the pop-up window to reset the starting and ending times to the beginning and end of the file.

NOTE

Touch the CANCEL button in the pop-up window to return to the ASSIGN or ENTRY screen.

Editing the playback starting and ending points using the number buttons and mark list screen

- When you touch the **EDIT** button on the Start End Point page of the **ADJUST XXX** screen, the **EDIT START POINT** or **EDIT END POINT** screen for editing the playback start or end point is shown.

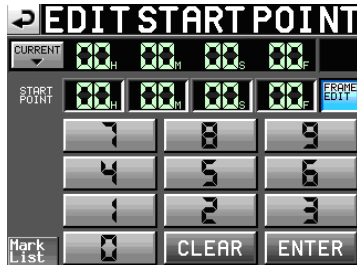

Use the **FRAME EDIT** button on the **EDIT START POINT** screen to set whether or not you will edit the frame value.

- Use the number buttons to input the playback start/end point.
 - If you begin input without selecting a unit, input will start from the smallest one.
 - To input a specific unit, touch it to make its background yellow, and then use the number buttons and the **DATA** dial to enter two digits at a time.
 - Touch the **CURRENT ▼** button to copy the current playback position to the input value.
 - Touch the **SET MAX ▲** button to set the end time of the file as the value.

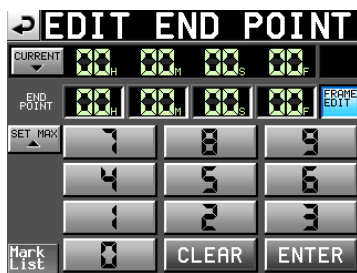

- Touch the **CLEAR** button to reset all values to 00.
- Touch the **Mark List** button to open the mark list where you can copy the time from a specific mark.

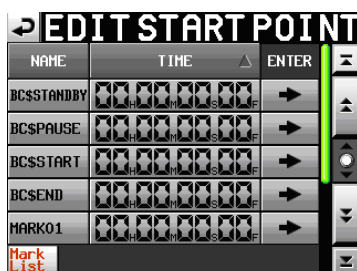

On this screen, touch the **→** button of next to a mark to copy its time to the playback start/end point and return to the **ADJUST XXX** screen.

- Touch the **ENTER** button to confirm the setting.

NOTE

When you change the playback start/end time, the length of the interval between the playback start and end times will be adjusted automatically so that it is longer than the total length of the fade-in and fade-out.

TIP

- You can also use the **PLAY** key and other transport keys while listening to the audio to find a location, and then touch the **CURRENT ▼** button to input that value.
- This can also be edited using an external keyboard on the **EDIT START POINT** and **EDIT END POINT** screens. Press the keyboard's **ESC** key to clear all values (set them to 00).

9 – Playlist mode

Editing playback starting times

1. Press the **HOME** key on the front panel to open the Home Screen.
2. Touch a file name or title name and then touch the **ADJUST ENTRY** button in the pull-down menu to open the **ADJUST XXX** screen (“XXX” is the entry number).

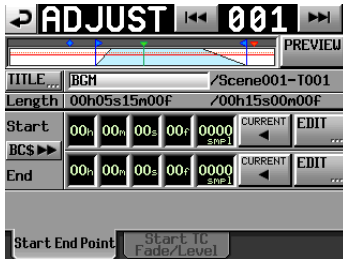

NOTE

When a take is selected on the **ENTRY** screen or one of the key assign buttons on the left is selected on the **ASSIGN** file screen, you can also open the **ADJUST** screen by touching the **MENU** button and then touching the **ADJUST** button in the pull-up menu.

3. Touch the **Start TC Fade/Level** tab to open the page shown below. The value shown next to the **Start TC** item is the playback starting time for the selected entry.

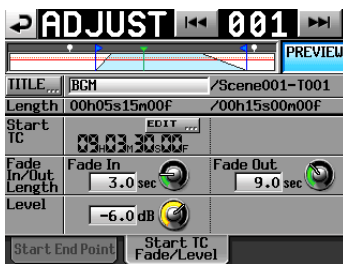

4. Touch the **EDIT** button to open the **EDIT START T/C** screen, and use the number buttons to change the **Start TC**.



Use the **FRAME EDIT** button on the **EDIT START T/C** screen to set whether or not you will edit the frame value.

5. Use the number buttons to input the playback starting time.
 - If you begin input without selecting a unit, input will start from the smallest one.
 - To input a specific unit, touch it to make its background yellow, and then use the number buttons and the **DATA** dial to enter two digits at a time.
 - Touch the **CURRENT** ▼ button to copy the current timecode to the input value.
 - Touch the **CLEAR** button to reset all values to 00.
7. Touch the **ENTER** button to confirm the setting.

TIP

- You can also use the **PLAY** key and other transport keys while listening to the audio to find a location, and then touch the **CURRENT** ▼ button to input that value.
- This can also be edited using an external keyboard.
- Press the keyboard's **ESC** key to clear all values (set them to 00).

Editing lengths and levels of fade-ins/outs

1. Press the **HOME** key on the front panel to open the Home Screen.
2. Touch a file name or title name and then touch the **ADJUST ENTRY** button in the pull-down menu to open the **ADJUST XXX** screen (“XXX” is the entry number).

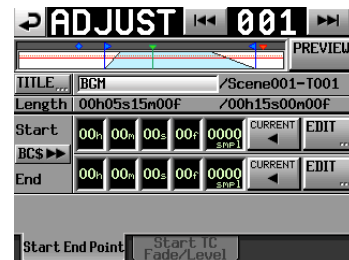

3. Touch the **Start TC Fade/Level** tab to open the page shown below.

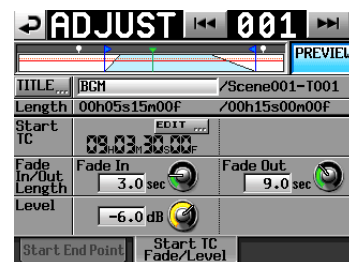

- Select the Fade In, Fade Out or Level knob, and turn the **DATA** dial to change the value.

Setting ranges:

Fade In / Out Length: 0–30 seconds
 (0.1 second per step or 1.0 second per step when the dial is pressed and rotated)
 Level: $-\infty$ to +10dB

NOTE

- When the length of the fade-in or fade out is changed, the value is automatically adjusted to stay within the length set by the playback start and end time.
- The playback level is shown by the solid red line.
- The nominal level (0dB) is shown by the dotted orange line.

Playback on ADJUST screens

You can use the transport controls while on an **ADJUST XXX** screen to play a take while you are adjusting its settings.

- Operation is the same as during normal transport operation except that the **◀◀** or **▶▶** keys are used to jump to the file beginning, Start Point, End Point and file end.
- If you change the Start Point or Fade In Length, the playback point will move to the Start Point. If you change these during playback, playback will resume after the playback point has moved.
- If you change the End Point or Fade Out Length, the playback point will move to the point below. If you change these during playback, playback will resume after the playback point has moved.

	PREVIEW OFF	PREVIEW ON
When changing End Point	Two seconds before End Point	Two seconds before Fade Out start point
When changing Fade Out Length	Two seconds before Fade Out start point	Two seconds before Fade Out start point

- Touch the **PREVIEW** button to change how playback occurs on the **ADJUST XXX** screen.

Playback when PREVIEW is OFF

- The original audio is played back without being affected by the Fade IN/OUT and Level Adjust settings.
- You can move out of the range between the Start and End Points.
- When the End Point is reached during playback, the playback position jumps back to the Start Point and stops.
- Press the **PLAY** key to start playback from the Start Point.
- Move to positions after the End Point by using the **▶▶** key, **▶▶|** key, **SHIFT+▶▶|** key and **JOG/SHUTTLE** dial.

Playback when PREVIEW is ON

- Only the range between the Start and End Points is played back. Locating to points outside this range is not possible.
- The audio is played back with the Fade IN/OUT and Level Adjust settings applied.

9 – Playlist mode

Saving playlists

You can save the current playlist in the session currently loaded as a JPPA PPL file.

CAUTION

After editing a playlist, save it as necessary. If you do not save a playlist after editing, all changes will be lost when, for example, you load another playlist, remove the selected card, or turn off the unit's power. An "*" appears in the file name or title name button when editing has occurred but it has not been saved yet. When an "*" is shown, a pop-up message asking if you want to save the playlist will appear when you try to do something that would clear the edits, including loading another playlist, creating a new playlist or changing the operation mode.

1. Press the **HOME** key on the front panel to open the Home Screen.
2. Touch a file name or title name button to open a pull-down menu and touch the **SAVE** button to start saving the playlist.



While saving, a progress status pop-up appears. When saving completes, the pop-up disappears.

NOTE

You can also save a playlist by touching the **MENU** button on the **ASSIGN** or **ENTRY** screen to open a pull-up menu and touching the **SAVE** button.



ENTRY list screen



ASSIGN file screen

Naming and saving playlists

On the **ENTRY** or **ASSIGN** screen, after touching the **MENU** button to open the pull-up, if you touch the **SAVE AS** button instead of the **SAVE** button, you can rename the playlist before saving it.

1. Press the **HOME** key on the front panel to open the Home Screen.
2. Touch a file name or title name button to open a pull-down menu and touch the **SAVE AS** button.



The **PLAYLIST NAME** screen where you can input a new playlist name opens.



3. Input the playlist name. Follow the procedures in "Editing project names" on page 40.
4. Touch the **Enter** button on the **PLAYLIST NAME** screen or press the **DATA** dial to save the playlist with this name. While the file is being created, a progress status pop-up appears. When file creation completes, the pop-up disappears.

NOTE

When a file with the input name already exists, a pop-up window confirming whether you want to overwrite the file is displayed. Touch the **OK** button to overwrite the file. Touch the **CANCEL** button to return to the **PLAYLIST NAME** screen.

TIP

You can also name and save a playlist by touching the **MENU** button on the **ASSIGN** file or **ENTRY** list screen to open a pull-up menu, and touch the **SAVE AS** button.



Playback in playlist mode

Project, session and playlist selection

1. Press the PROJECT key on the front panel to open the PROJECT screen.

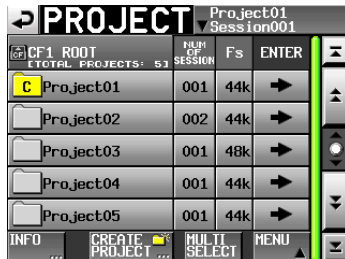

2. Touch the → button next to the project that contains the playlist that you want to play to open the session selection screen.
If the selected project is not the current project, a pop-up window appears confirming that you want to load it. Touch the OK button.



3. Touch the → button for the session that contains the playlist that you want to play to open the playlist selection screen.
If it is not the current session, a pop-up window appears confirming that you want to load it. Touch the OK button.



TIP

You can also touch the current project/session name button at the top right of the PROJECT screen to open the playlist selection screen for the current session.

4. Touch the name of the playlist that you want to play to select it. Its background becomes yellow.
5. Touch the MENU button on the Playlist selection screen to open a pull-up menu.



Playlist selection screen pull-up

6. Touch the LOAD button in the pull-up menu to load the playlist.
A confirmation pop-up window appears.



7. Touch the OK button or press the DATA dial.
When loading completes, the Home Screen opens.

NOTE

On the playlist selection screen, you can also touch the → button for the playlist that you want to play to load it instead of touching the MENU button followed by the LOAD button in the pull-up menu item.
When the same pop-up message as shown above appears, touch the OK button or press the DATA dial.

Online function settings

Refer to "Online function" on page 129 to make online output settings.

9 – Playlist mode

Playback control in playlist mode

Press the **PLAY** key to start playback.

Press the **PAUSE** key to pause playback.

Press the **PLAY** key again to resume playback.

Press the **STOP [RETAKE]** key to stop playback.

Press the **⏮ [MARK ⏮]** key or **⏭ [MARK ⏭]** key to skip to the next take.

Press and hold them **⏮ [⏮]** or **⏭ [⏭]** key to search backward or forward.

Press the **⏮ [MARK ⏮]** or **⏭ [MARK ⏭]** key while pressing and holding the **SHIFT** key to move between marks.

Press and hold them **⏮ [⏮]** or **⏭ [⏭]** key while pressing and holding the **SHIFT** key to search at high-speed.

NOTE

- On the **PLAY SETUP** screen, you can set whether only the currently selected take is played or whether all the takes in the current session are played. You can also enable and disable repeat playback. (See “Playback settings (PLAY SETUP)” on page 102.)
- Playback functions can also be performed using a remote control connected through the parallel connector.

Using the call function

Press the **CALL [CHASE]** key to locate to the point where playback was last started from playback standby (call point) and put the unit in playback standby mode.

BWF-J cue point (playlist mode)

When the Follow BWF-J item is set to ON, if a BWF-J cue point is detected during playback, the following corresponding operation will occur. In addition, if the BWF-J Tally Out item is set to ON, in response to each BWF-J cue point, the cue signal and tally signal will be output from the parallel remote connector.

BC\$STANDBY	When an entry is selected, the transport locates to the first BC\$STANDBY point as the playback start point. During playback, playback pauses when this cue point is detected. In either case, a BC\$STANDBY tally is output.
BC\$CM	During playback, when this cue point is detected, a BC\$CM CUE signal is output.
BC\$END	During playback, when this cue point is detected, a BC\$END CUE signal is output.
BC\$STOP	During playback, when this cue point is detected, a BC\$STOP CUE signal is output, and playback stops.
BC\$FILE	During playback, when this cue point is detected, a BC\$END CUE signal is output. If there is a BC\$STANDBY cue point in the next entry, playback will move to it and pause at that point. A BC\$STANDBY tally is output.
BC\$PAUSE	During playback, when this cue point is detected, a BC\$PAUSE tally is output, and playback pauses.

Using the flash start function

Flash start playback is possible using a TASCAM RC-HS32PD or RC-HS20PD (sold separately) or other remote controller.

For details, see “Flash start function” on page 130.

In this chapter, we explain how to use the unit when it's operation mode is on-air mode (See "Selecting the operation mode" on page 47.)

Please refer to "4–Basic operation" on page 29 when reading this chapter and "In on-air mode" on page 22.

Selecting files for playback

In this mode, you can select audio files in the CF card root folder for playback. (Only files that have the same sampling frequency as the current unit setting can be played back.)

1. Touch the information area or the take name button on the Home Screen to open a pull-down menu, and touch the **ON AIR LIST** button to open the **ON AIR LIST** screen. You can also push the **PROJECT** key to open the **ON AIR LIST** screen. The **ON AIR LIST** screen shows the audio files that match the set sampling frequency in the root directory of the CF card in file name order.
The **ON AIR LIST** screen shows the audio files that match the set sampling frequency in the root directory of the CF card in file name order.
2. Touch the **SELECT** buttons on the left side of the **ON AIR LIST** screen to check/uncheck files. Checked files will be used for on-air playback. Remove a check mark, making the box gray, to deselect the file for on-air playback.



NOTE

- By default, all files in the root folder of the CF card are checked.
- Only files that match the currently set sampling frequency (Fs) are shown.
- Even if the Fs setting matches, files with more than 2 channels and other files that cannot be played back by this unit will not be recognized or shown.
- The maximum number of audio files that can be recognized and shown is 100. If the root folder contains more than 100 files with the currently set Fs, the first 100 (in file name order) will be recognized.
- The **SELECT** buttons can only be used when playback is stopped and the **ON AIR** button is OFF.
- The **LENGTH** column item shows the length of the playable area of the file. Beneath the "LENGTH" column name at the top right, the total playback time of all the selected files is shown.
- Touch the **INFO** button to open a pop-up window that shows information about the file of the currently selected take if there is one.



If there is no take selected currently, or there are no valid files at all, the Fs setting and card capacity information is shown.



Playback area in on-air mode

ON AIR button	BWF-J Follow	BC\$END Mode	Playable area
OFF	–	–	Entire take
ON	OFF	–	Entire take
ON	ON	Normal	Entire take
ON	ON	Jump to Standby	If next take has BC\$STANDBY mark: BC\$STANDBY to BC\$END
			If next take does not have BC\$STANDBY mark: BC\$STANDBY to take end

NOTE

- If there is no BC\$STANDBY mark, playback is from the take beginning
- If there is no BC\$END mark, playback is until take end
- Marks other than BC\$STANDBY and BC\$END have no effect on the playback area.
- For details about the use of BC\$END MODE, see "GENERAL page (playback settings)" on page 102.

Examples of playback areas when the ON AIR button is ON, Follow BWF-J is ON and the BC\$ END mode is Jump to Standby

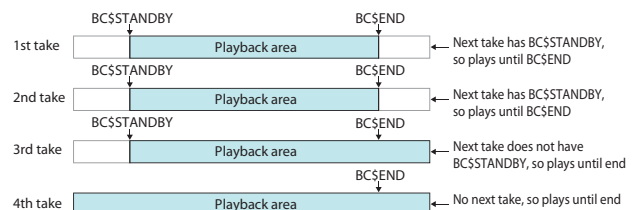

10 – On-air mode

Using the ON AIR button to switch between rehearsal/confirmation playback and broadcast playback modes

You can use the ON AIR buttons on the HOME and ON AIR LIST screens to switch between “rehearsal/confirmation” and “broadcast” playback modes.

- ON AIR button ON (red): broadcast playback mode
The CREDITS playback button is disabled, and only the playback area can be played back. (The CREDITS playback and ON AIR LIST screen check and file name buttons are also disabled.) When you switch from OFF to ON, the Home Screen time counter changes to total time display and playback pauses at the beginning of the first take.
- ON AIR button OFF: rehearsal/confirmation playback mode
The CREDITS playback button is enabled, and locating to and playing back any part of a file (take) is possible.

When you switch from ON to OFF, the Home Screen time counter is automatically set to elapsed time display.

NOTE

The ON AIR button can only be used when the transport is stopped.

Playback control in on-air mode

Press the **PLAY** key to start playback.

Press the **PAUSE** key to pause playback.

Press the **PLAY** key again to resume playback.

Press the **STOP [RETAKE]** key to stop playback.

Press the **◀◀ [MARK ◀◀]** key or **▶▶ [MARK ▶▶]** key to skip to the next entry.

Press and hold the **◀◀ [◀◀◀◀]** or **▶▶ [▶▶▶▶]** key to search backward or forward.

Press the **◀◀ [MARK ◀◀]** or **▶▶ [MARK ▶▶]** key while pressing and holding the **SHIFT** key to move between marks.

Press and hold the **◀◀ [◀◀◀◀]** or **▶▶ [▶▶▶▶]** key while pressing and holding the **SHIFT** key to search at high-speed.

NOTE

- On the PLAY SETUP screen, you can set whether only the currently selected take is played or whether all the takes in the root folder are played. You can also enable and disable repeat playback. (See “Playback settings (PLAY SETUP)” on page 102.)
- Playback functions can also be performed using a remote control connected through the parallel connector.

Credits playback

This function makes it easy to play just the beginnings of files.

The term “credits” is commonly used in Japan for the audio played at the introduction of a program.

1. Turn off the ON AIR button on the HOME or ON AIR LIST screen.
2. Set the current file (take) using the ON AIR LIST screen file name buttons or the **◀◀** and **▶▶** keys.

NOTE

- Only playable files can be set as the current take.
 - After starting up, changing the Fs or activating on-air mode, the first playable file in the list will be selected as the current take for playback.
3. Touch the CREDITS playback button on the HOME or ON AIR LIST screen to start credits playback of the current take from its beginning. Playback stops when the appropriate mark is reached.
 - When the Follow BWF-J setting is ON, playback continues from the beginning of the file to the first BC\$STANDBY mark.
 - When the Follow BWF-J setting is OFF, playback continues from the beginning of the file to the first mark.
 - If neither of the above conditions apply, the file plays until its end and then playback stops.

During playback, the take name button of the file being played back appears green on the ON AIR LIST screen.



4. During credit playback, you can press the CREDITS playback button to stop playback.

NOTE

The take name and CREDITS playback buttons on the ON AIR LIST screen can only be used when the ON AIR button is OFF and playback is stopped or during credit playback. They cannot be used when the ON AIR button is ON or during ordinary playback.

Using the call function

Press the **CALL [CHASE]** key to locate to the point where playback was last started from playback standby (call point) and put the unit in playback standby mode.

BWF-J cue point (on-air mode)

When the Follow BWF-J item is set to ON, if a BWF-J cue point is detected during playback, the following corresponding operation will occur. In addition, if the BWF-J Tally Out item is set to ON, in response to each BWF-J cue point, the cue signal and tally signal will be output from the parallel remote connector

BC\$STANDBY	When the ON AIR button is turned ON, the transport locates to the first BC\$STANDBY point in the first take as the playback starting point. During playback, playback pauses when this type of cue point is detected.* In either case, a BC\$STANDBY tally is output. *If BC\$END Mode is set to Jump to Standby, playback will pause.
BC\$CM	During playback, when this cue point is detected, a BC\$CM CUE signal is output.
BC\$END	During playback, when this cue point is detected, a BC\$END CUE signal is output. "If BC\$END Mode is set to Jump to Standby and the next take has a BC\$STANDBY cue point, playback will continue from that point.
BC\$STOP	During playback, when this cue point is detected, a BC\$STOP CUE signal is output, and playback stops.
BC\$FILE	During playback, when this cue point is detected, a BC\$END CUE signal is output. If there is a BC\$STANDBY cue point in the next entry, playback will move to it and pause at that point. A BC\$STANDBY tally is output.
BC\$PAUSE	During playback, when this cue point is detected, a BC\$PAUSE tally is output, and playback pauses.

Changing the sampling frequency in on-air mode

You can change the sampling frequency when playback is stopped in on-air mode using the **CLOCK** page of the **SYNC T/C** screen.

1. Touch the **SYNC** button on the Home Screen or the **SYNC T/C** button on the **MENU** screen to open the **SYNC T/C** screen **CLOCK** page.

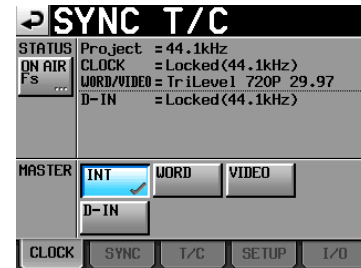

2. Touch the **ON AIR F_s** button at the top left of the screen to open the **ON AIR F_s** screen.

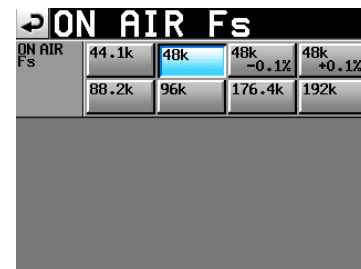

3. Touch the button for the desired sampling frequency to open a confirmation message. Touch the **OK** button.
4. When a second confirmation message appears, touch the **OK** button again.

NOTE

- After you change the sampling frequency (Fs), only files that match the selected Fs will be shown on the **ON AIR LIST** screen.
- Even if the Fs setting matches, files with more than 2 channels and other files that cannot be played back by this unit will not be recognized.

Limitations in on-air mode

- Certain settings (repeat mode, auto cue, auto ready, incremental play) on the **PLAY SETUP** screen will be turned OFF when the operation mode is switched to on-air mode. They can be turned ON, but this change will not be retained.
- In on-air mode, marks cannot be set, edited or cleared. If you press the Mark key, a pop-up appears, warning "Cannot set Mark point in ON AIR Mode."
- The **EDIT NAME**, **EDIT TIME** and **DELETE** buttons on the Mark list screen will appear disabled.

11 – Internal settings

In this chapter, we explain the internal settings of the unit in detail.

Menu screen

Press the **MENU** key on the front panel to open the MENU screen as shown below.

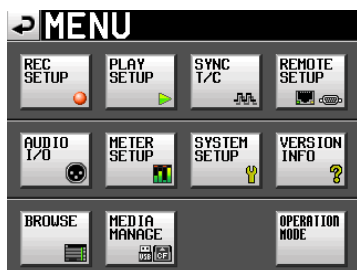
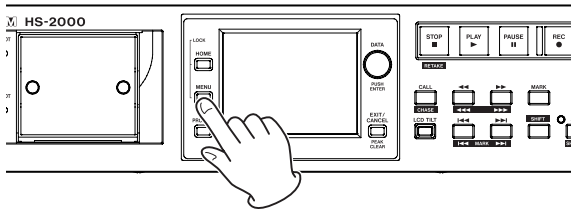

- **REC SETUP button**
Make recording settings.
- **PLAY SETUP button**
Make playback settings.
- **SYNC T/C button**
Make synchronization and timecode settings.
- **REMOTE SETUP button**
Make settings for external remote control.
- **AUDIO I/O button**
Make settings related to the input and output audio signals.
- **METER SETUP button**
Make level meter settings.
- **SYSTEM SETUP button**
Make system settings.
- **VERSION INFO button**
View the system version.
- **BROWSE button**
View and perform operations on the folders and files on CF cards and USB memory.
- **MEDIA MANAGE button**
Perform operations, including copying and formatting, on CF cards and USB memory.
- **OPERATION MODE button**
Set the operation mode.

Recording settings (REC SETUP)

The REC SETUP screen has three tabbed pages: REC MODE, FILE FORMAT and OPTIONS.

Touch a tab at the bottom of the screen to open the corresponding page.

REC MODE page

Make settings related to the recording mode.

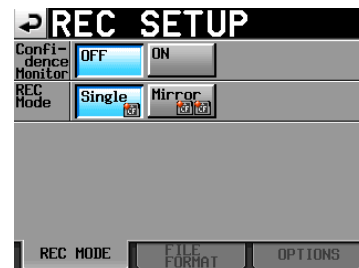

Confidence Monitor

Turn the confidence monitoring function, which allows immediate playback of the recorded signal for monitoring, ON (default) or OFF.

To use the confidence monitoring function, however, the sampling frequency and number of tracks must be set as follows.

Fs (sampling frequency)	44.1k, 48k, 48k-0.1% or 48k+0.1%
REC Mode	Single

NOTE

If the current project Fs setting is 88.2k, 96k, 176.4k or 192kHz, or REC Mode is set to Mirror, the Confidence Monitor setting will be fixed to OFF.

REC Mode

Single	The unit records only to the currently selected CF card (default).
Mirror	The unit records to both CF cards simultaneously.

NOTE

If the current project Fs setting is 88.2k, 96k, 176.4k or 192kHz, or Confidence Monitor is set to ON, the REC Mode setting will be fixed to Single.

FILE FORMAT page

Make settings related to the file format.

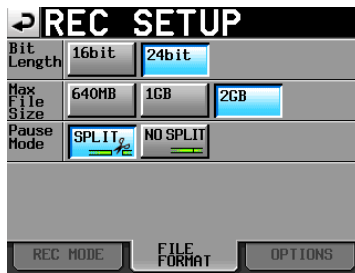

Bit Length

Set the quantization bit rate for recording files using the following buttons.

Setting buttons: 16bit (default), 24bit

Max File Size

Set the maximum size for recording files using the following buttons.

Setting buttons: 640MB, 1GB, 2GB (default)

Pause Mode

Set whether or not to create separate files when recording is paused using the following buttons.

Setting buttons: SPLIT (default), NO SPLIT

OPTIONS page

Make settings related to pre-recording and auto markers.



PreREC Time

Turn this function ON or OFF and set the length of pre-recording time. (Default: OFF)

When PreREC Time is ON, signals input during recording standby are captured and stored in the built-in memory for the length of time set here, allowing up to 5 seconds of the signal input before recording is started manually to be recorded and temporarily stored.

To set the pre-recording time, touch the knob, and adjust the value using the **DATA** dial.

Setting range: 1–5 seconds (default: 2 seconds)

Auto Marker

Make settings related to auto markers.

- Audio Over

Use this to add markers when the set audio level is exceeded.

Turn this function ON or OFF and set the trigger level. (Default: OFF)

To set the trigger level, touch the knob, and adjust the value using the **DATA** dial.

Setting options: **-0.20dB (default), -0.17dB, -0.13dB, -0.10dB, -0.06dB, -0.03dB**

Settings made here are reflected in the Over Level setting on the **METER SETUP** screen.

- Time Interval

Use this to add marks at fixed time intervals. Turn this function ON or OFF and set the time interval. (Default: OFF)

To set the time, touch the knob, and adjust the value using the **DATA** dial.

The range of setting values is 1–10 minutes (default: 5 minutes).
- Sync Unlock

Use this to add a mark when synchronization with the master clock is lost. Turn this function ON or OFF. (Default: OFF)
- PRE/REC/END

When ON, marks are added automatically at the pre-recording start point, recording start point and recording end point. (Default: OFF)

NOTE

- An Audio Over event occurs when the level exceeds the maximum level (0 dBFS) minus the value set by the user. (In the example above, this would be when the level exceeds the maximum level minus 0.20 dB.)
- PRE/REC/END auto markers are only added to takes in take mode. They will not appear on the timeline in timeline mode.
- After an Audio Over or Sync Unlock auto marker has been added, the same type of mark will not be added again until at least 10 seconds have passed since the last such mark was added.

11 – Internal settings

Playback settings (PLAY SETUP)

Make settings related to playback.

GENERAL page (playback settings)

Make settings related to the playback mode.



Play Mode

Set how the playback of takes and entries is handled using the following buttons. This setting affects all modes except timeline mode.

One Take (default) Only the currently selected take or entry is played back.

All Take All the takes in the currently loaded session or all the entries in the playlist are played back.

Repeat Mode

Turn repeat playback ON and OFF (default).

Follow BWF-J (default: OFF)

Turn the BWF-J cue point function ON or OFF.

This setting can be made separately for each mode.

When the BWF-J cue point function is ON, operation will follow BWF-J cue points set in sessions and takes. For details about operation, see the following pages.

- Timeline mode:
(See "BWF-J cue point (timeline mode)" on page 51.)
- Take mode:
(See "BWF-J cue point (take mode)" on page 74.)
- Playlist mode:
(See "BWF-J cue point (playlist mode)" on page 96.)
- On-air mode:
(See "BWF-J cue point (on-air mode)" on page 99.)

BC\$END Mode (On-air mode only)

In on-air playback mode, you can change the function of BC\$END marks.

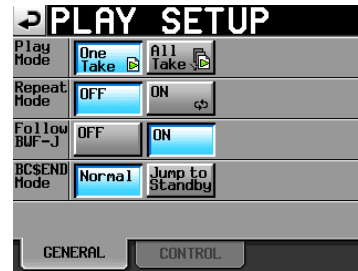

Normal (default)	An END tally is output and playback continues.
Jump to Standby	An END tally is output and the transport jumps to the BC\$STANDBY mark of the next take and playback continues. If the next take does not have a BC\$STANDBY mark, playback will continue without jumping.

NOTE

This setting can only be enabled when in on-air mode. It is not shown in other operation modes.

CONTROL page

Make various playback function settings.



Auto Cue (default: OFF)

Set whether auto cue is ON or OFF.

If auto cue is ON, whenever a take is changed or loaded, the unit will enter playback standby at the first point in the take where the signal exceeds the level set here.

If there is no signal in the take above the Auto Cue level and Play Mode is set to One Take, the transport stops at the start of the take. If there is no signal in the take above the Auto Cue Level and Play Mode is set to All Take, the unit will start searching for a signal in the next take.

This setting affects all modes except timeline mode.

To set the auto cue start point detection level, touch the knob area and use the **DATA** dial to change the value.

Setting options -72dB, -66dB, -60dB, -54dB (default), -48dB, -42dB, -36dB, -30dB, -24dB

Auto Ready (default: OFF)

Set whether auto ready is ON or OFF.
If auto ready is ON, when playback of a take completes the unit automatically stops at the beginning of the next take.
This setting affects all modes except timeline mode.

Inc. Play (default: OFF)

Set whether the incremental play function is ON or OFF.
When incremental play is ON, you can press the **PLAY** key during playback to move to the beginning of the next take and continue playing. You can also press the **STOP [RETAKE]** key during playback to move to the beginning of the next take and pause playback.
This setting affects all modes except timeline mode.

PLAY Inhibit Time

This sets a time interval during which playback of the same take (entry) cannot be restarted.
Following the start of take playback, the following controls are disabled for the duration set here.

Front panel	PLAY key
Remote control (TASCAM RC-HS32PD/RC-HS20PD) (sold separately)	PLAY key, flash start keys and fader start function
External control (RS-232C, RS-422, Parallel, Keyboard)	Play and flash start commands

Setting range: 0 (default)–1000 msec (100 msec intervals), Inf (during playback the affected keys are disabled)

NOTE

If PLAY Inhibit Time is set to Inf, the incremental play function is automatically set to OFF and cannot be changed.

Sync and timecode settings (SYNC T/C)

Make various audio synchronization and timecode settings.

This screen has five pages: **CLOCK**, **SYNC**, **T/C**, **SETUP** and **I/O**.

Touch a tab at the bottom of the screen to open the corresponding page.

CLOCK page

View various clock status information and select the clock used for synchronization.

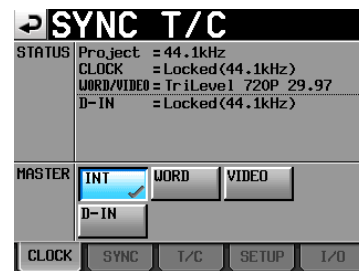

STATUS

Project:

Shows the sampling frequency of the project.

CLOCK:

Shows the clock synchronization status.

WORD/VIDEO:

Shows WORD, VIDEO or TriLevel, depending on the synchronization signal is being received.

D-IN:

Displays the digital input signal status as shown in the following table.

Digital input signal status	Display
When locked	Locked (xx.xxx kHz)
When sampling rate conversion is ON	Locked (xx.xxx kHz FsCnv)
When unlocked	Unlocked (xx.xxx kHz)
When no signal received	Unlocked (No Signal)
When non-audio signal received	Not Audio
Other Cbit information differs from the actual operation mode	Unmatched Cbit

MASTER

Use the buttons to select which master clock to use.

INT (default):

Use the unit's internal clock.

WORD:

Synchronize with a word clock signal received through the WORD/VIDEO IN connector.

VIDEO:

Synchronize with a video clock signal received through the WORD/VIDEO IN connector.

11 – Internal settings

D-IN:

Synchronize with the clock of the digital audio signal selected as the input for DIGITAL IN.

You cannot select a digital audio input to be used as the master clock if the sampling rate converter is ON for that input.

NOTE

- A check mark appears on the button of the currently active master clock.
- If synchronization from an external clock is interrupted, the internal clock becomes active. In this case, the check mark appears on the INT button to show that it has become the active clock, and an X mark appears on the button of the selected external clock that lost synchronization.

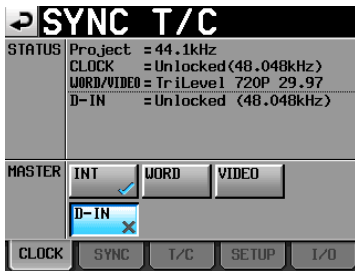

SYNC page

Make settings related to synchronization on this page.

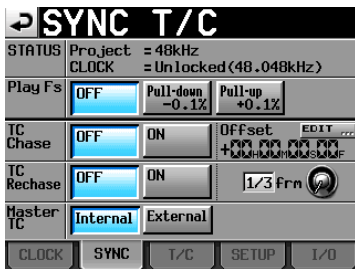

STATUS

Shows the status of the currently loaded project's sampling frequency and timecode (clock) synchronization.

Play Fs

When playing a take that has been recorded with a sampling frequency of 48 kHz, 48 kHz pull-up or 48 kHz pull-down, the unit can be made to synchronize with an external clock with a different sampling frequency (48 kHz, or 48 kHz pull-up or 48 kHz pull-down) by setting it to play back with pull-up or pull-down.

Depending on the combination of project sampling frequency and Play Fs settings, the unit will operate with the sampling frequency shown below (default: OFF).

Project sampling frequency	Play Fs setting		
	OFF	Pull-down	Pull-up
48kHz	48 kHz	48 kHz-0.1%	48 kHz+0.1%
48kHz pull-down	48 kHz-0.1%	Not possible	48 kHz
48kHz pull-up	48 kHz+0.1%	48 kHz	Not possible
All others	Project sampling frequency	Not possible	Not possible

CAUTION

Set this to OFF before recording.

Recording is not possible when set to Pull-up +0.1% or Pull-down -0.1%. If you try to record when not set to OFF, a pop-up appears warning, "Cannot RECORD".

TC Chase (default: OFF)

Use to turn timecode synchronization ON or OFF.

Set it to ON when you want to match the timing of this unit's audio playback with timecode from a master device (audio recorder, video unit or built-in timecode generator).

You can also set the timecode offset (TC Offset) relative to the timecode master device.

Touch the EDIT button to open the CHASE Offset screen where you can set the offset value in a range between -23:59:59.29 and +23:59:59.29 (default: 00:00:00.00).

NOTE

TC Chase can also be turned ON and OFF by pressing the SHIFT and CALL keys at the same time.

TC Rechase

Turn this function, which re-synchronizes when timecode synchronization becomes inaccurate during playback, ON or OFF (default).

When set to OFF, after initial synchronization, input timecode is ignored and the unit operates in free run mode.

Set the amount of inaccuracy that triggers rechasing when TC Rechase is ON.

To set the amount of inaccuracy that triggers rechase, touch the knob and turn the DATA dial to select a value in frames of 1/3, 1, 2 (default), 5 or 10.

Master TC

Set whether the unit synchronizes with the built-in timecode generator or with timecode received from another device.

Internal : Synchronize with the built-in generator.

External (default) : Synchronize with timecode from another device.

T/C page

Make settings related to timecode on this page.

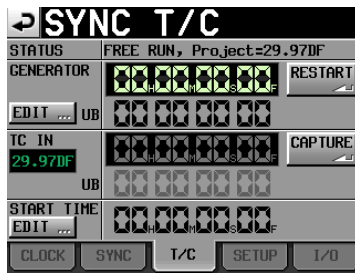

Free Run mode

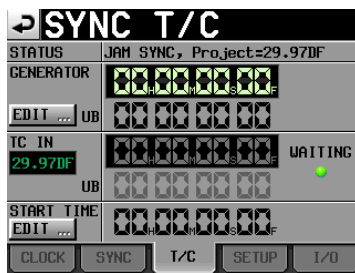

Jam Sync (or Free Once)

STATUS

This shows the timecode generator mode of the unit and the timecode frame type of the currently loaded project.

GENERATOR

The top line shows the current timecode generator time. The bottom line shows the user bits (UB). Touch the GENERATOR item EDIT button or the user bits (UB) number area to open the T/C USER BITS screen.

When the timecode generator is in Free Run mode, touch the RESTART button to reset the timecode of the timecode generator to the start time.

TC IN

The top line shows the time of the input timecode and the frame type. The bottom line shows the user bits (UB) of the input timecode.

In Free Run mode, touch the CAPTURE button to capture the current timecode and set it as the timecode of the timecode generator.

If the timecode generator mode is set to Free Once or Jam Sync, the capture status (WAITING) indicator lights green when waiting for timecode, and it turns off after timecode is captured.

START TIME

When you touch the GENERATOR item RESTART button, the time when the timecode restarts is shown. Touch the START TIME item EDIT button or the START TIME display area to open the START TIME screen.

SETUP page (Sync and timecode settings)

Make settings related to the timecode generator on this page.

STATUS

This area shows the currently loaded project's timecode frame type.

TC GEN MODE

Use the buttons to set the timecode generator mode.

FREE RUN:

The timecode generator runs on its own.

FREE ONCE:

The unit's timecode generator captures the received timecode once, and then runs independently.

TIME OF DAY:

If you conduct any of the following operations, the timecode value is captured from the unit's internal date/time clock and the unit timecode generator runs on its own.

- Turn the power on
- Set TC GEN MODE to this mode
- Reset the internal clock

JAM SYNC:

When timecode is received, the unit synchronizes to it. If timecode input is interrupted, the unit timecode generator runs on its own.

REGEN:

The unit synchronizes to the received timecode.

REC RUN (default):

The timecode generator only functions during recording. At all other times, the timecode generator stops.

Frame Type

Set the timecode frame type of the currently loaded project.

Setting buttons: 23.976F, 24F, 25F, 29.97DF (default), 29.97ND, 30DF, 30ND

11 – Internal settings

I/O page

View the synchronization signal status and set timecode output on this page.



STATUS

This shows the status of synchronization signals.

TIMECODE IN:

When timecode is received, the timecode frame rate is shown.

WORD/VIDEO IN:

When a synchronization signal is received through this connector, WORD, VIDEO or TriLevel is shown.

TC Out Mode

Use the buttons to set the timecode output mode.

GenOut button:

Timecode from the internal timecode generator is output.

PlayOut button (default):

In timeline mode, the timecode time for playback and recording is output. In take and playlist modes, the timecode recorded in the file is output during playback.

Remote settings (REMOTE SETUP)

Make settings for the **PARALLEL**, **RS-232C**, **RS-422** and **ETHERNET** connectors.

The **REMOTE SETUP** screen has 5 pages: **GENERAL**, **PARALLEL**, **RS-232C**, **RS-422** and **ETHERNET**.

Touch a tab at the bottom of the screen to open the corresponding page.

GENERAL page (Remote settings)

Make common external remote control settings on this page.

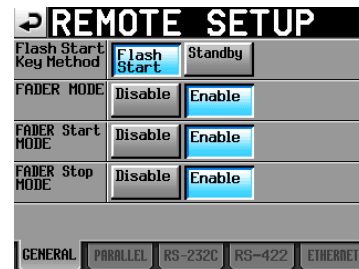

Flash Start Key Method

Set how the flash start keys operate.

Flash Start (default):

Touching a flash start key starts flash playback.

Standby:

When stopped, touch a flash start key to enter playback standby. Then, press the **PLAY** key to start playback.

During playback, touching another flash start key causes the corresponding take or entry to be cued for playback (without stopping the currently playing entry). Press the **PLAY** key to start playback of that entry. If the Play Mode is set to All Take, when the currently playing entry completes playback, the cued entry starts playback. If the Play Mode is set to One Take, when the currently playing entry completes playback, the cued entry is enters playback standby.

NOTE

When an RC-HS20PD is connected, this setting is fixed to Flash Start and cannot be changed to Standby.

FADER MODE

Set whether faders on external TASCAM HS32PD/RC-HS20PD remote controllers (sold separately), for example, are enabled or disabled. When set to Disable, the internal fader is fixed at 0 dB.

Setting buttons: Disable, Enable (default)

FADER Start MODE

When the fader start function of an external remote controller is ON, this enables or disables the fader start function, which allows you to start playback from playback standby by raising the fader from $-\infty$.

Setting buttons: Disable, Enable (default)

FADER Stop MODE

When the fader stop function of an external remote controller is ON, this enables or disables the fader stop

function, which allows you to enter playback standby from playback by lowering the fader to $-\infty$.
Setting buttons: Disable, Enable (default)

NOTE

If both FADER Start MODE and FADER Stop MODE are set to Disable, the fader start function of the external TASCAM HS32PD/RC-HS20PD remote controller (sold separately) will be turned off automatically, and the FADER START indicator will turn off. In this state, if you press the Fader Start key on the TASCAM RC-HS32PD remote controller, a “Cannot Change Now. Fixed in current mode” pop-up warning appears.

PARALLEL page

Set the AUX 1-3 functions of the **PARALLEL** connector.

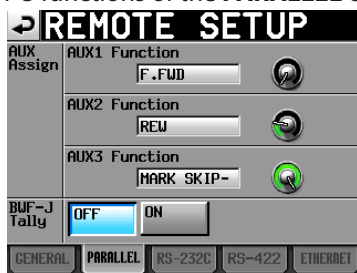

AUX Assign

Touch a knob to select it, making the parameter background yellow, and turn the **DATA** dial to select the parameter. The parameters that can be selected include F.FWD, REW, MARK, MARK SKIP-, MARK SKIP+, ONLINE and CALL.

- AUX1 Function (default: **MARK SKIP+**):
Set the function of **PARALLEL** connector pin 17 (AUX1).
- AUX2 Function (default: **MARK SKIP-**):
Set the function of **PARALLEL** connector pin 18 (AUX2).
- AUX3 Function (default: **MARK**):
Set the function of **PARALLEL** connector pin 19 (AUX3).

BWF-J Tally

When not operating in BWF-J mode (when Follow BWF-J is OFF), set whether a BWF-J tally is output.
Setting buttons: OFF (default), ON

NOTE

BWF-J tallies are always output when operating in BWF-J mode.

RS-232C page

Make RS-232C serial control transmission settings on this page.

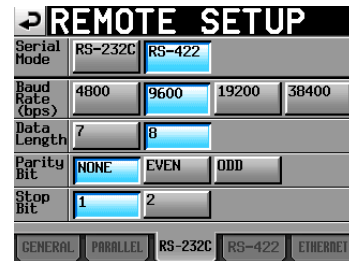

Serial Mode

Set the serial connection mode with the following buttons.

Setting buttons: RS-232C, RS-422 (default)

NOTE

- The **RS-232C** and **RS-422** connectors cannot both be used at the same time. Only the connector selected with this setting can be used.
- This setting is synchronized with the Serial Mode item on the RS-422 page.

Baud Rate (bps)

Set the transmission speed (baud rate) with these buttons.

Setting buttons (bps): 4800, 9600, 19200, 38400 (default)

Data Length

Set the data length in bits with these buttons.

Setting buttons (bits): 7, 8(default)

Parity Bit

Set whether there is a parity bit and the type with these buttons.

Setting buttons: NONE (default), EVEN, ODD

Stop Bit

Set the stop bit with these buttons.

Setting (bit): 1 (default) or 2

11 – Internal settings

RS-422 page

Make RS-422 serial control transmission settings on this page.

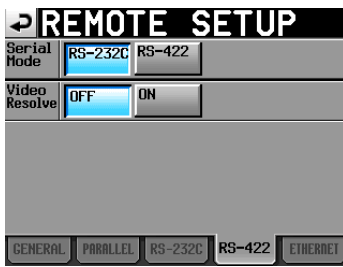

Serial Mode

Set the serial connection mode with the following buttons.

Setting buttons: RS-232C, RS-422 (default).

NOTE

- The **RS-232C** and **RS-422** connectors cannot both be used at the same time. Only the connector selected with this setting can be used.
- The Serial Mode setting is synchronized on both the RS-422 and RS-232C pages (changes made on one will be reflected on the other).

Video Resolve

When slaving this unit to a VCR, video sync signals might be used instead of word sync signals for the common standard clock. In the same way as with word sync signals, you can select whether the timecode follows the video clock (synchronizing the beginning of time code frames with video signal frame edges) or is independent from the video frame clock. This must be turned ON to control this unit from a video editor.

ON (default): Time code frame beginnings synchronized with video signal frame edges
 OFF: Independent from video frame clock

ETHERNET page

Make settings related to ETHERNET communication on this page.

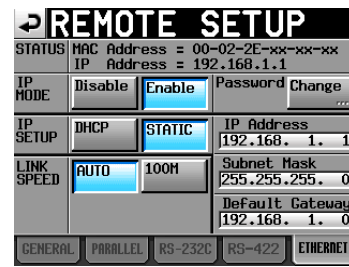

STATUS

Shows the MAC address and the current IP address of this unit.

IP MODE

These buttons enable or disable the ETHERNET function.

Setting buttons: Disable (default), Enable

IP SETUP

These buttons set whether the IP address is set by DHCP or is STATIC.

In DHCP mode, if a DHCP server exists on the same LAN network as the unit, IP address, Subnet Mask and Default Gateway settings are automatically obtained. In STATIC mode, IP Address, Subnet Mask and Default Gateway values must be set manually.

Setting buttons: DHCP, STATIC (default)

LINK SPEED

These buttons set the link speed.

Setting buttons: Auto (default, negotiates the best possible link speed according to the network environment)

100M (operates with a fixed link speed of 100 Mbps)

IP Address/Subnet Mask/Default Gateway

In STATIC IP address mode, use these to set and view the values used.

Defaults: 0.0.0.0

Depending on the IP SETUP setting, the display of this area will change as follows:

IP Address 192.168.1.1	IP Address 192.168.1.1	IP Address 192.168.1.1
Subnet Mask 255.255.255.0	Subnet Mask 255.255.255.0	Subnet Mask 255.255.255.0
Default Gateway 192.168.1.0	Default Gateway 192.168.1.0	Default Gateway 192.168.1.0

Set to DHCP

Set to STATIC

When touched

Changing the IP Address, Subnet Mask and Default Gateway settings

Touch the corresponding area on the ETHERNET page of the REMOTE SETUP screen to display a setting adjustment screen.

- Each unit uses three digits, but for values of two digits or fewer, leading zeroes can be omitted.
- The largest (first) unit is selected when the screen opens.
- After selecting a unit, touching a number button clears the numbers in the unit and enters only that digit. Enter additional numbers as you would with a calculator.
- Touch the dot (".") button to move the selection to the next unit.

Example:

First unit selected	192.168.1.1	
Input 1, 2, 3, 4	234.168.1.1	First "1" is discarded
Input "."	192.168.1.1	Moves to next unit.

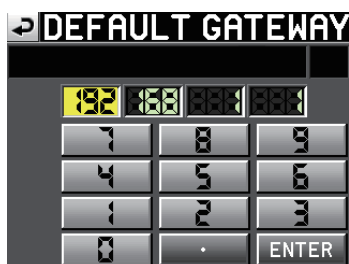
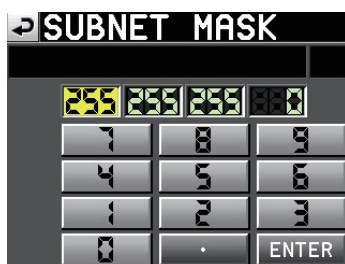
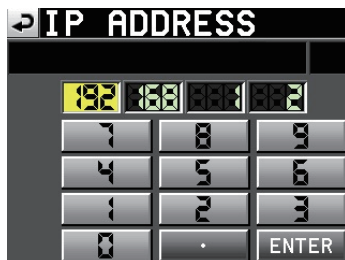

Changing the password setting

Touch the Password Change button on the ETHERNET page of the REMOTE SETUP screen to open the CHANGE PASSWORD screen where you can set the password. Up to nine characters can be entered.

See "13 – Other functions" for details about password use.



11 – Internal settings

Audio Signal Input and Output settings (AUDIO I/O)

Use the AUDIO I/O screen to make input and output settings related to audio signals.

This screen has three pages: INPUT, OUTPUT and SETUP.

Touch a tab at the bottom of the screen to open the corresponding page.

INPUT page

Make input settings on this page.



INPUT SOURCE

Set the input source to analog or digital input.

Setting buttons: Analog (default), Digital

Fs CONVERT

Turn the sampling rate converter ON or OFF (default).

OUTPUT page

This shows the output settings and signal route.

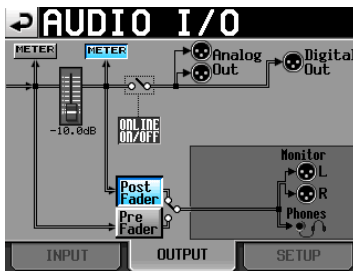

METER buttons

Use these buttons to set whether the meter shows the levels before or after the fader.

Touch the left METER button to show the pre-fader level or touch the right METER button to show the post-fader level.

Post/Pre Fader

Use these buttons to set whether the monitor output is from before or after the fader.

Pre Fader:

Signals before the fader are output for monitoring.

Post Fader (default):

Signals after the fader are output for monitoring.

Fader

When an RC-HS32PD or RC-HS20PD is connected, its fader level is shown.

When no remote is connected, it is fixed at 0dB.

Setting audio signal inputs and outputs (SETUP page)



Monitor Mute by Online

Set whether monitoring is automatically muted or not during online playback (default: OFF).

Level meter settings (METER SETUP)

Make level meter settings on this screen.

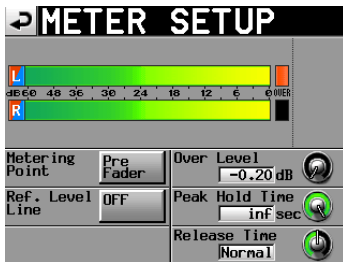

Metering Point

Set whether the meters show the signals before or after the fader.



Meters show the signals before the fader (default).



Meters show the signals after the fader. In this case, the button appears light blue.

Ref. Level Line

Touch to turn the reference level line ON (default) or OFF. When ON, it appears as a blue line crossing both level meters.

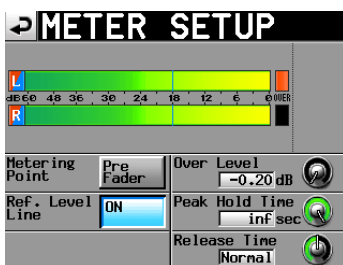

Reference level line ON

Over Level

Use this to set the level at which the overload indicator lights. The overload indication level is the maximum level (full scale) minus this amount.

Touch this knob and use the **DATA** dial to adjust this level.

Setting -0.20dB (default), -0.17dB, -0.13dB,
options: -0.10dB, -0.06 dB, -0.03 dB.

This setting is reflected in the Audio Over setting of the Auto Marker item on the **OPTIONS** page of the **REC SETUP** screen (changing this value on one screen will change it on the other).

Peak Hold Time

Use this to set the peak hold time.

Touch this knob and use the **DATA** dial to adjust the time.

Setting 0 sec, 1 sec, 2 sec (default), inf (hold forever)
options:

Release Time

Use this to set the release time.

Touch this knob and use the **DATA** dial to adjust the time.

Setting options: Slow, Normal (default), Fast

NOTE

If the release time is set to inf, you can reset the peak hold indicators from the Home Screen by pressing the **EXIT/CANCEL [PEAK CLEAR]** key.

11 – Internal settings

System settings (SYSTEM SETUP)

Make system settings on this screen.

The SYSTEM SETUP screen has 4 pages:

PREFERENCES, ANALOG Ref LEVEL ADJUST, Backup/Startup and CLOCK ADJUST.

Touch a tab at the bottom of the screen to open the corresponding page.

PREFERENCES page

Set system preferences on this page.

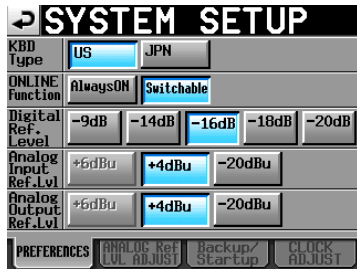

KBD Type

Set the connected keyboard type to either US for US English-language keyboards or JPN for Japanese keyboards.

Setting buttons: US, JPN (default)

ONLINE Function

Set how the online function works (default: Switchable).

Set to "Switchable" to allow online playback mode to be enabled from the parallel connector, serial connector (RS-232C) or TASCAM RC-HS32PD/RC-HS20PD remote control (sold separately).

Set to AlwaysON to disable switching of online playback, and always output the sound from all connectors. For details, see "Online function" on page 129.

Digital Ref. Level

Set the reference level for digital inputs and outputs to a number of decibels below the maximum level (full scale).

Setting options: -9dB, -14dB, -16dB, -18dB, -20dB (default)

Analog Input Ref. Lvl

Set the reference level for analog inputs.

The options depend on the Digital Ref. Level setting.

Digital Ref. Level setting	Analog Input Ref. Lvl
-9dB	Fixed at +6dB
Not -9dB	+4dB or -20dB

Analog Output Ref. Lvl

Set the reference level for the analog line outputs.

The options differ according to the Digital Ref. Level setting.

The options depend on the Digital Ref. Level setting.

Digital Ref. Level setting	Analog Output Ref. Lvl
-9dB	Fixed at +6dB
Not -9dB	+4dB or -20dB

NOTE

Audio received through the analog audio inputs at the analog input reference level is converted into digital audio at the digital reference level.

Digital audio at the digital reference level is converted to analog audio at the analog output reference level and played back through the analog audio outputs.

ANALOG Ref LVL ADJUST page

You can make fine adjustments to the analog input and output reference levels for each channel independently.

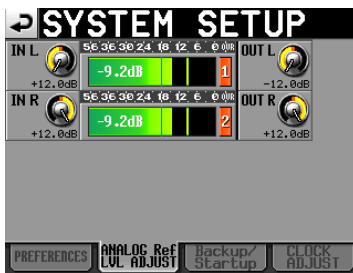

Use an IN X knob (“X” is L or R) to adjust the analog input level of the corresponding channel, and use an OUT X knob to adjust the analog output level of the corresponding channel.

Touch a knob to select it, making its area yellow, and use the **DATA** dial to adjust the level.

Turn the dial to adjust it in 0.1dB intervals, and press and turn the dial to adjust it in 1dB intervals. The value is shown beneath each knob.

Setting range: -6dB to +6dB (default: 0dB)

If the **INPUT SOURCE** on the **INPUT** tab of the **AUDIO I/O** screen is set to Digital instead of Analog, the corresponding knob will not be shown and “Analog IN not selected” will appear in the menu area.

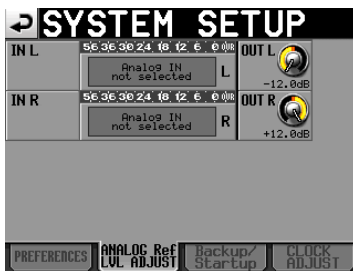

Not set to analog input

Backup/Startup page

You can import and export system files, save and load user settings, and set the startup mode using the **Backup/Startup** page of the **SYSTEM SETUP** screen.



■ System Backup

- Use the Export button to write all System Backup data (including User Preset settings) to the selected card. Only one set of System Backup data can be saved on a card.
- Use the Import ALL button to load all System Backup data (including User Preset settings) from the selected card and overwrite the built-in memory with it.
- The imported User Preset settings are immediately applied to the operation of the unit.
- Use the Import User button to import only the User Preset settings from the System Backup data on the selected card and overwrite the User Preset in the built-in memory with it.
- Imported User Preset settings are not immediately applied to the operation of the unit. After importing, touch the LOAD Preset User button to apply the User Preset settings.
- If there are no System Backup files, a pop-up window indicating that the import cannot be performed appears.

■ Save User Preset

Press the Save button save the current setting values as the User Preset in the built-in memory.

■ Load Preset

Touch the User button to load the User Preset settings or the Factory button to load the Factory Preset settings (the values when first shipped new).

■ Startup MODE

Last Setting : Load previous settings when turned on

User Preset : Load User Preset settings when turned on

Factory Preset : Load Factory Preset settings when turned on

11 – Internal settings

NOTE

- The following settings, which are not included in the project, are saved and loaded in presets.

Screen name	Page name	Settings in presets
Home Screen		Time counter display mode
LOCK SETUP screen		All settings
PLAY SETUP screen	CONTROL page	PLAY Inhibit Time
SYNC T/C screen	CLOCK page	MASTER
	SYNC page	Master TC
ON AIR Fs screen		ON AIR Fs
REMOTE SETUP screen	GENERAL page	FADER MODE
		FADER Start MODE
		FADER Stop MODE
	PARALLEL page	AUX Assign
RS-232C page	All settings	
ETHERNET page	All settings	
AUDIO I/O screen	INPUT page	INPUT SOURCE
SYSTEM SETUP screen	PREFERENCE page	ONLINE Function
		Digital Ref. Level
		Analog Input Ref. Lvl
	Analog Output Ref. Lvl	
ANALOG Ref. LVL ADJUST page	All settings	
Backup/Startup page	Startup MODE	
OPERATION MODE screen		Whether operation mode is on-air mode or a different mode (If this setting is not on-air mode, the operation mode saved on the CF card will be activated)

- The User Preset settings are the same as the Factory Preset settings when the unit is first shipped new.
- If the unit is restarted without saving the User Preset after changing the Startup Mode to User Preset when the Startup Mode setting stored in the User Preset memory is Last Setting or Factory Preset, the User Preset settings are loaded. Then, the Startup Mode settings will change to the Last Setting or Factory Preset setting stored in the User Preset memory. In this case, you do not need to reload the Last Setting or Factory Preset settings. The next time the unit is restarted, the Last Setting or Factory Preset settings will be loaded.

CLOCK ADJUST page

Set the time of the built-in clock on this page.

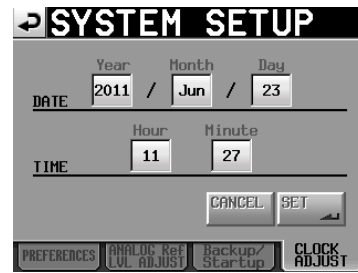

Touch the item to set, and use the **DATA** dial to adjust it. (See “Setting the built-in clock” on page 26.) Touch the **SET** button on the **CLOCK ADJUST** page or press the **DATA** dial to confirm the setting.

NOTE

While setting the time, the clock stops and the “:” does not blink. When you touch the **SET** button, the clock starts again and the “:” blinks.

Viewing system and firmware versions (VERSION INFO)

This screen shows the version of the system.



Touch the bottom center of the screen to show the versions of internal sub-systems and those of the active TASCAM RC-HS32PD/RC-HS20PD remote controller (sold separately) if connected.

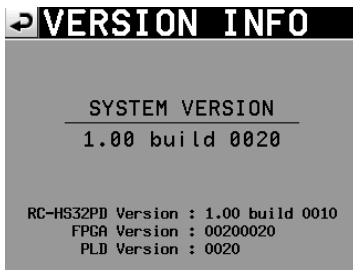

Viewing and using folders and files (BROWSE)

This section describes how to view and use folders and files on CF cards and USB flash memory.

- Viewing folders and files
- Viewing folder and file information
- Deleting folders and files
- Copying folders and files

Viewing folders and files

1. Press the **MENU** key on the front panel to open the **MENU** screen.

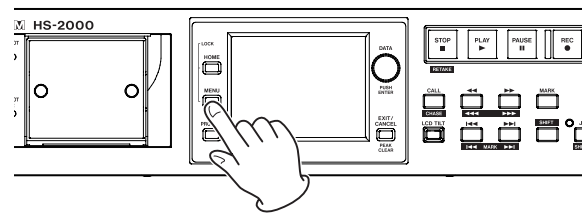

2. Touch the **BROWSE** button to open the **BROWSE** screen.
The first time it is opened, the media selection screen appears.
The second time it is opened and thereafter, the content of the media/folder last opened appears.

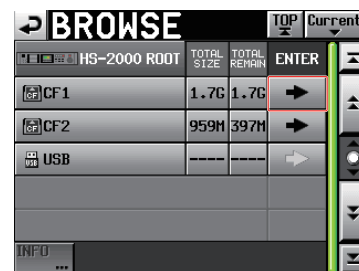

Opening CF1

NOTE

- Touch the **TOP** button to return to the media selection screen.
- Touch the **Current** button to open the current session folder in the current media.
- The icon **C** for the current project/session folder in the current media appears yellow with a "C" on it.

11 – Internal settings

3. Touch a media/folder → button to open it and see its content.



Opening Project01 folder

4. Touch a sub-folder → button to open it and see its content.



5. Touch the media/folder name button at the top left of the screen to reopen it and close the sub-folder.



Opening CF1

Viewing folder and file information

1. Open the media/folder containing the folder/file you want to view.

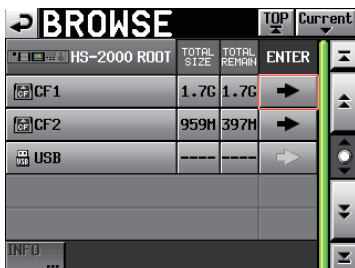

Opening CF1

2. Select the folder/file.

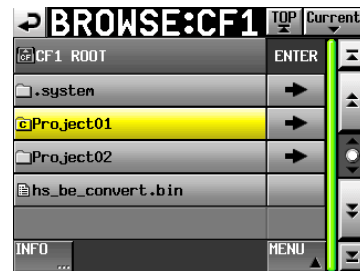

Opening Project01 folder

The selected folder/file appears yellow.

3. Touch the INFO button to open a pop-up with information about the selected folder/file.

- If a folder is selected, the creation date and time are shown.



- If a file other than a BWF/WAV file is selected, the date and time last changed and file size are shown.



- If a BWF/WAV file is selected, the following information is shown.



- Date and time last changed
- File size
- Sampling frequency
- Bit length/Number of channels
- Length/START T/C

Copying a folder/file

1. Press the **MENU** key on the front panel to open the **MENU** screen.

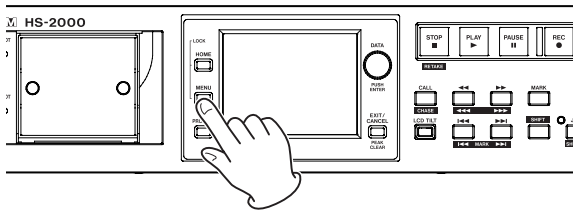

2. Touch the **BROWSE** button to open the **BROWSE** screen.

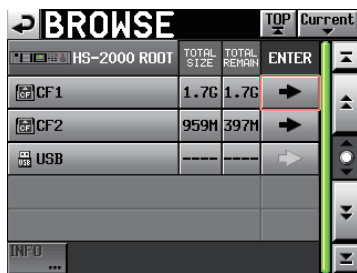

Opening CF1

3. Open the media/folder containing the folder/file you want to copy.

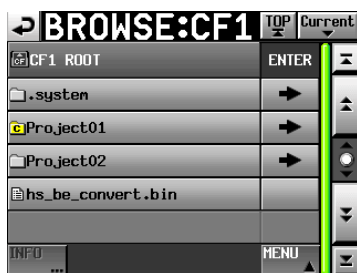

Opening Project01 folder

4. Select the folder/file you want to copy. The selected folder/file appears yellow. Touch the **MENU** button to open a pull-up menu.



5. Touch the **COPY** button in the pull-up menu to open the copy destination folder selection screen.
6. Open the copy destination folder.
 - When copying for the first time, the media selection screen opens. Touch the **→** button for the media containing the copy destination folder.



Media selection screen the first time

- When copying after the first time, the last opened copy destination folder selection screen reopens.

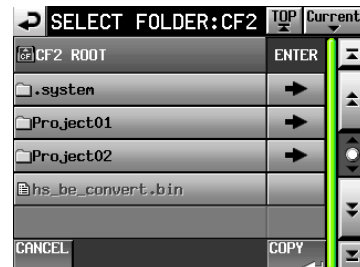

Previously open CF card reopens

NOTE

- After the copy destination has been selected, the **BROWSE** screen title changes to **SELECT FOLDER** and blinks.
- When a copy destination has been selected, touch the **CANCEL** button or **↶** button to return to the **BROWSE** screen.

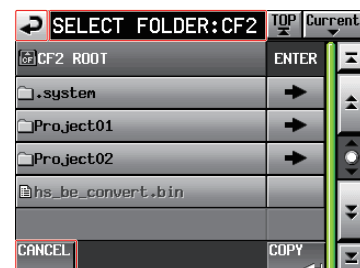

11 – Internal settings

7. Touch the **COPY** button to open a confirmation pop-up.
Touch the **OK** button or press the **ENTER** key to copy.

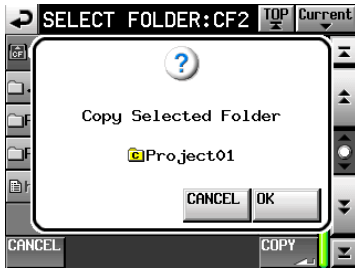

To cancel copying or go back to change the copy destination, touch the **CANCEL** button.

NOTE

If a folder/file with the same name already exists in the copy destination, a pop-up appears, warning, "Cannot Copy Folder or Cannot Copy File". To change the name of the copied folder/file, touch the **RENAME** button.
For how to enter names, see "Editing project names" on page 40.



Touch the **CANCEL** button to cancel copying.

8. A pop-up window opens while copying. When copying is complete, the pop-up window disappears and the **BROWSE** screen reopens.

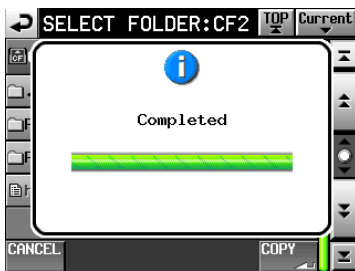

Deleting a folder/file

1. Press the **MENU** key on the front panel to open the **MENU** screen.

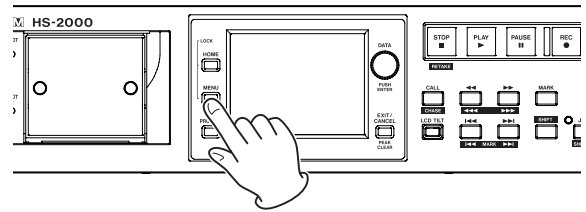

2. Touch the **BROWSE** button to open the **BROWSE** screen.



Opening CF1

3. Open the media/folder containing the folder/file you want to delete.



Opening Project01 folder

Select the folder/file to delete.
The selected folder/file appears yellow.

4. Touch the **MENU** button to open a pull-up menu.



5. Touch the **DELETE** button in the pull-up menu.

6. When a confirmation pop-up appears, touch the **OK** button or press the **DATA** dial.



7. Another confirmation pop-up will appear. Touch the **OK** button or press the **DATA** dial to delete the file.



To cancel deletion, touch the **CANCEL** button.

8. During deletion, a pop-up window appears.

When deletion completes, the pop-up window closes and the **BROWSE** screen reopens.



CAUTION

You can delete folders and files that are being used by timeline and playlist modes. If you delete such a folder or file, an error pop-up will appear if you attempt to play a corresponding region or entry.

NOTE

If an audio file from the current session is deleted, a rebuild confirmation pop-up appears. Execute the rebuild. If you do not do this, the management file and audio files will not match, and Play Error pop-up warnings might appear.

If rebuilding is necessary,  marks appear on the following buttons.

Touch the **REBUILD** button, which is found in several menus, to rebuild the session.

- File name display button on the Home Screen
- **MENU** button on the **PROJECT** screen
- **REBUILD** buttons in various menus

11 – Internal settings

Managing media (MEDIA MANAGE)

You can select, copy and format CF cards and USB flash memory.

CAUTION

If you use any of the FORMAT commands, all the data on that media will be erased. Likewise, the COPY commands erase all the data on the destination media before copying. Execute these commands only if you are absolutely certain that you want to erase the media.

CURRENT MEDIA

This shows the currently selected media and its status.

MEDIA SELECT

This opens the MEDIA SELECT screen where you can set the media used for recording and playback.

CF FORMAT

Use to format the selected CF card.

QUICK button	This only formats CF card management information.
FULL button	This formats the entire CF card.
QUICK & Create Project button	After formatting only the CF card management information, a new project is automatically created with the same settings as the current project.

USB FORMAT

Use to format USB flash memory.

QUICK button	This only formats USB memory management information.
FULL button	This formats the entire USB memory.

MEDIA COPY

This copies the contents of one media to another.

CF1 → CF2/ CF2 → CF1	This copies the entire contents of the first CF card to the second CF card.
CF1 → USB/ CF2 → USB	This copies the entire contents of the selected CF card to the USB flash memory.
USB → CF1/ USB → CF2	This copies the entire contents of the USB flash memory to the selected CF card.

Selecting the operation mode (OPERATION MODE)

Set the unit's operation mode on this screen.

After selecting the operation mode, touch the **SET** button to enable it and open the Home Screen for that mode. See "6 – Operation Modes" on page 46.

TIMELINE MODE

Select and touch **SET** to activate timeline mode and open its Home Screen.

TAKE MODE

Select and touch **SET** to activate take mode and open its Home Screen.

PLAYLIST MODE

Select and touch **SET** to activate playlist mode and open its Home Screen.

ON AIR MODE

Select and touch **SET** to activate on-air mode and open its Home Screen.

Folder structure

The folder structure is as shown below.

You can check the folder and file structure of a CF card by accessing it from a computer using a card reader, for example.

Be aware, however, if you use a computer to change or erase files inside a project, or change any names, the unit might become unable to play that project.

NOTE

Other management files and folders are created in addition to these.

CAUTION

Do not save data in the ".system\backup" folder created for management on each media. Doing so could cause data to be deleted.

File names

The format used in naming files is as follows.

[Take name first half]-[letter][take number].wav

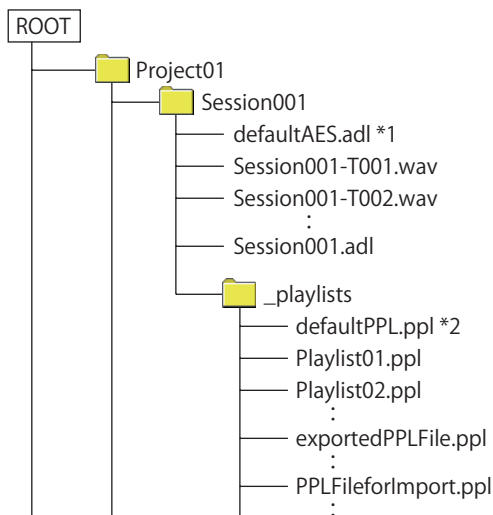

*1: This AES31 file is automatically created

*2: This PPL file is automatically created

12 – Mark and locate functions

Mark functions

Adding marks

One timeline mode or one take can have a maximum of 99 marks, including automatically-created marks.

Use the following methods to create marks.

- Push the **MARK** key on the front panel
Press the **MARK** key to add a mark at the current playback/recording time. In timeline mode, marks are only added to the timeline. They are not added to the files themselves.
Mark names are assigned using a "MARK XX" format.

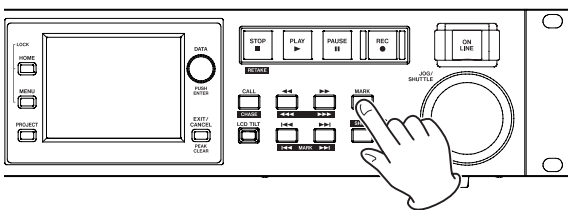

- Use the auto marker functions

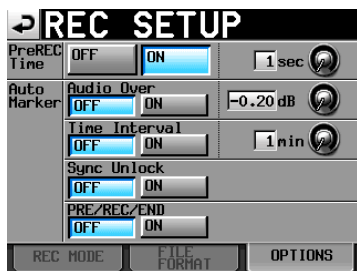

Marks can be added automatically when audio overs occur, at regular time intervals, when synchronization errors occur and when recording starts and stops (including when prerecording starts). These marks are added when the appropriate auto marker function is turned ON. (See "OPTIONS page" on page 101.)

In timeline mode, marks are added to both the timeline and the file itself.

Marks are named according to how they were made.

When auto mark is made	Mark name
Audio over occurs	OVER xx
At specified time intervals	TIME xx
Synchronization error occurs	UNLK xx

CAUTION

The following auto marks are only added to the file (take), and will not appear in the timeline in timeline mode.

When auto mark is made	Mark name
Recording start point	REC xx
Recording end point	END xx
Pre-recording start point	PRE xx

NOTE

- An "Audio Over" occurs when the level exceeds the maximum level (full scale) minus the value set by the user. (In the example above, this would be when the level exceeds the maximum level minus 0.20 dB.)
- If an event that would create a mark is received from a parallel control, a mark is added as if the **MARK** key had been pushed.
- After an Audio Over or Synchronization Error auto marker is added, additional events of the same type will not cause additional marks to be added until at least 10 seconds have passed.

Using keys to locate to marks

Press the **MARK I◀◀** key or **▶▶ MARK** key while pressing and holding the **SHIFT** key to locate to the previous or next mark.

NOTE

The unit will also locate to the next or previous mark when a **MARK SKIP +/-** event is received from a parallel control.

Mark list screen

Touch the **Mark List** button on the Home Screen to open the **MARK LIST** screen.



NAME button

Touch to sort by mark name in descending or ascending order.

When the mark names are sorted in ascending order, a ▲ icon appears inside the **NAME** button. When in descending order, a ▼ icon appears inside this button.

TIME button

Touch to sort marks by time in descending or ascending order. When they are sorted by time in ascending order, a ▲ icon appears inside the **TIME** button. When in descending order, a ▼ icon appears inside this button.

Mark name buttons

Touch to select a mark.

LOCATE (👉) buttons

Touch this button to locate to the corresponding mark.

LIST INFO button

Touch this button to open the mark list information screen that shows the number of marks by type in the currently selected take.

EDIT NAME button

Touch this button to open the **MARK NAME** screen where you can edit the name of the selected mark.

EDIT TIME button

Touch this button to open the **MARK EDIT** screen where you can edit the position of the selected mark.

MULTI SELECT button

Use this to enable the selection of multiple marks.

DELETE button

Touch this button to delete the selected mark(s).

Scroll buttons

Use these buttons to scroll to the beginning or end of the mark list or scroll one page (five lines) forward or backward. Use the **DATA** dial to scroll through the mark list one line at a time.

Locating to marks

Touch a 👉 button to locate to the corresponding mark.

Viewing mark information

Touch the **LIST INFO** button on the **MARK LIST** screen to open the **LIST INFO** page.

This screen shows a list with the number of marks by type in the currently loaded take.

Touch the **LIST INFO** button again to return to the **MARK LIST** screen.

TYPE	COUNT
TOTAL	8
MANUAL MARK	5
TIME	0
OVER	0
UNLK	0

Mark list information screen

NOTE

After recording, the **MARK LIST** screen might show a **TOTAL** number of marks that is 2 or 3 greater than the sum of the **MANUAL MARK**, **TIME**, **OVER** and **UNLK** marks. This is because the total includes **REC**, **END** and sometime **PRE** (prerecording) marks that are created during recording.

12 – Mark and locate functions

Deleting marks

1. Select the mark (or marks) to be deleted on the MARK LIST screen.



MARK LIST screen

2. Touch the DELETE button on the MARK LIST screen.
3. When a confirmation pop-up message appears, touch the OK button or the DATA dial to delete the mark (or marks).

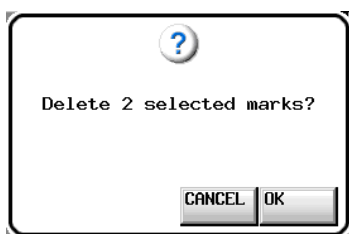

Erasing marks using the MARK LIST screen

NOTE

On the mark list information screen, you can select the type of mark that you want to delete and touch the DELETE button to delete all the marks of that type. When you do this, a "Delete all marks of this type?" confirmation pop-up appears. Touch the OK button or press the DATA dial to delete all the marks of that type.



Mark list information screen



Deleting all marks of one type using the mark list information screen.

Editing mark positions

Use the MARK list to change the position (time) of marks added with the MARK key (marks named "MARK xx").

NOTE

You cannot edit the positions of marks added automatically.

1. Select the mark that you want to edit on the MARK LIST screen.



2. Touch the EDIT TIME button to open the MARK EDIT screen. Touch the FRAME EDIT button to set whether or not the frame value is editable.

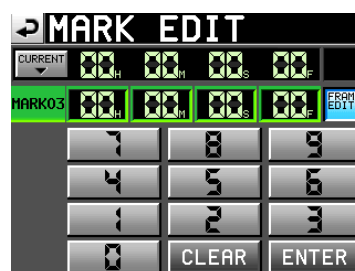

Frame editing on

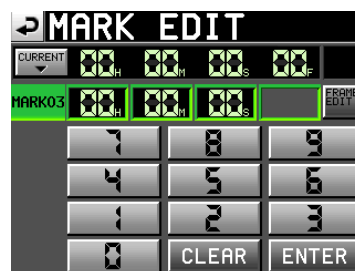

Frame editing off

3. Touch the number buttons to input mark time values, or use the DATA dial to change the time for the selected unit. Touch the ENTER button to confirm the setting and return to the MARK LIST screen.
 - If you begin input without selecting a time unit, input will start from the smallest one.
 - To input a specific time unit, touch it to change its background to yellow, and then use the number buttons and the DATA dial to enter two digits at a time.
 - Touch the CURRENT ▼ button to copy the current playback position to the input value.
 - Touch the CLEAR button to reset all values to 00.

TIP

This can also be edited using an external keyboard. Press its Enter key to confirm a setting and its ESC key to reset all values to 00.

Editing mark names

1. Select the mark that you want to edit on the MARK LIST screen.



2. Touch the EDIT NAME button to open the MARK NAME screen.



Follow the procedures in “Editing project names” on page 40.

If you want to edit the name of a BWF-J cue point, touch the BCS button at the top right to open a cue name pull-down menu where you can select the desired type.



NOTE

You can also open the MARK NAME screen by touching the mark name area on the Home Screen. Since the names of automatic marks cannot be edited, the MARK NAME screen will not open for them.



Manual locate function

You can directly input a time to locate to it.

Touch the Manual Locate button on the Home Screen to open the MANUAL LOCATE screen.

Touch the FRAME EDIT button to set whether or not the frame value is editable.

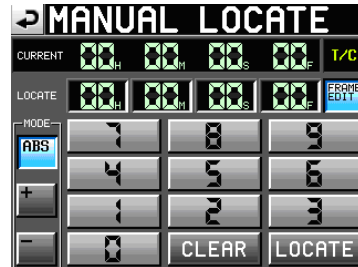

Frame editing on

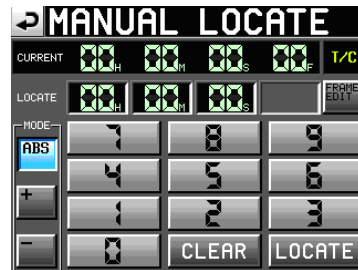

Frame editing off

There are three locate modes as follows.

ABS: Input an actual time and locate to it.

+ : Input the amount of time to go forward from the current time.

- : Input the amount of time to go backward from the current time.

Input the time using the number buttons.

You can also select a unit in the LOCATE area and use the DATA dial to adjust the time.

Touch the LOCATE button to locate to that new time and return to the Home Screen.

Touch the CLEAR button to clear all input values.

Touch the CLEAR button to reset all values to 00.

NOTE

If the CURRENT time display is set to T/C, the timecode is used as reference for locating times .

TIP

This can also be edited using an external keyboard.

Press its Enter key to confirm a setting and its ESC key to reset all values to 00.

13 – Other functions

Confidence monitoring

While recording, the recorded audio can be played back from the media immediately and output for monitoring.

1. Press the **MENU** key on the front panel to open the MENU screen.

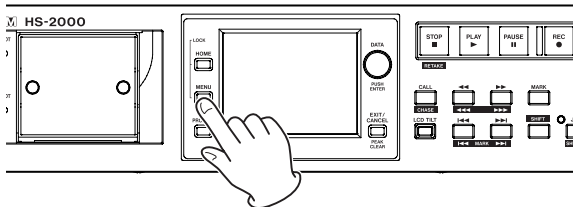

2. Touch the **REC SETUP** button to open the REC SETUP screen.

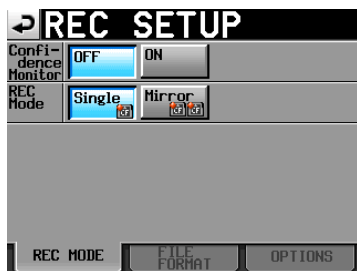

3. Touch the **Confidence Monitor ON** button to enable the confidence monitoring function (default: ON).

Requirements for confidence monitoring

To use the confidence monitoring function, the following settings must be as below.

Fs (sampling frequency) 44.1k, 48k, 48k-0.1% or 48+0.1k

REC Mode Single

NOTE

- If the current project Fs setting is 88.2k, 96k, 176.4k or 192kHz, or REC Mode is set to Mirror, the Confidence Monitor setting is fixed to OFF
- The sampling frequency (Fs) is set when a project is created. It cannot be changed after project creation.
- When using confidence monitoring, the playback signal is delayed about 2.4 seconds relative to the recorded source before it is output.
- When a region (take) is divided or the recording region (take) reaches the maximum size, the confidence monitoring playback signal will be interrupted for a few seconds.

Mirror recording

Mirror recording allows you to record to two CF cards simultaneously.

1. Load CF cards in both Slot 1 and Slot 2.
2. Press the **MENU** key on the front panel to open the MENU screen.

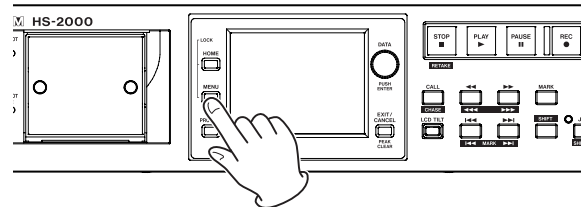

3. Touch the **REC SETUP** button to open the REC SETUP screen.



4. Touch the **REC Mode Mirror** button to activate mirror recording. (The default REC MODE setting is Single.)

Requirements for mirror recording



To use the mirror recording, these settings must be as follows.

- Fs (sampling frequency): 44.1k, 48k, 48k-0.1% or 48+0.1k
- Confidence Monitor: OFF

NOTE

If the current project Fs setting is 88.2k, 96k, 176.4k or 192kHz, or the Confidence Monitor setting is ON, the REC Mode will be fixed to Single.

- Setting button appearance

REC mode setting	Buttons
Single	
Mirror	
Mirror (set, but recording not possible* or Mirror recording disabled**)	

*Conditions that make recording impossible:

- The space remaining on the current CF card is insufficient.
- The currently selected CF card is not mounted.
- The CF card set as the current media is not a compatible media type (PIO mode).
- The format of the current CF card is not compatible (not FAT16 or FAT32).
- A CF card already has a take with a name that matches the NEXT TAKE NAME setting and is numbered 999. ("----" is shown for the number on the NEXT TAKE NAME screen.)
- The total number of entries in the current folders of both CF cards (total numbers of files and folders) exceeds the system limitation.
- Recording/Editing has been repeated in timeline mode, and there is not enough memory available for managing region and editing history, so recording cannot be performed. ("RecLimit" appears in the CF card remaining space display button.)

**Conditions that disable mirror recording

- The remaining space on the mirroring (not currently selected) CF card is insufficient. (Recording is also impossible if the remaining space on the currently selected CF card is exhausted*)
- The mirroring CF card is not mounted. (Recording is also impossible if the currently selected CF card is not mounted.*)
- The mirroring CF card is not compatible media type. (PIO mode) (Recording is also impossible if the currently selected CF card is not compatible.*)
- The mirroring CF card format is not compatible (not FAT16 or FAT32). (Recording is also impossible if the currently selected CF card format is not compatible.*)
- The CF card is not compatible with UDMA.
- One or both of the CF cards has not been formatted by this unit (not formatted with the recommended cluster size).

➔ If any of the above conditions applies, mirror recording will not occur, but recording to the current media will proceed.

NOTE

- If set to Mirror, a project/folder identical to the current project/folder of the current CF card is created on the mirroring CF card.
- If you start recording when set to Mirror, takes with the same name are recorded into the matching project/folder on both CF cards.
- If you retake when set to Mirror, only the take on the current CF card is deleted. The take on the mirroring CF card is not deleted.

- When set to Mirror, if the current CF card cannot be recorded to, recording is impossible, even if the mirroring CF card has space available.
- When mirror recording, if the time counter display mode is TOTAL REMAIN, the remaining recordable time for the CF card with the least remaining space is shown. If one of the CF cards runs out of space during mirror recording, the remaining recordable time for the CF card that continues recording is shown.

Various messages

- If the REC Mode is changed to Mirror when Mirror is disabled, the following messages are shown.

- ① When one of the CF cards cannot be recorded to



- ② If a CF card is not compatible with UDMA



- ③ If one of the CF cards has not been formatted by this unit



13 – Other functions

- If recording starts when mirror recording is disabled, the following messages are shown.

① When mirror recording is disabled for any reason other than ② or ③ below.



② A CF card is not compatible with UDMA



③ A CF card has not been formatted by this unit



- If space runs out or an error occurs on either of the CF cards during recording when set to Mirror, recording will stop on the card with no space remaining or where the error occurred. Recording of the current file to the other card will also stop, but recording will immediately continue with the next take as a new file. Then, a message will be shown and the CF card remaining space display buttons will appear as follows:

① When one CF card has run out of space



Remaining time buttons



② If a recording error has occurred on one of the CF cards



Remaining time buttons



Online function

The **ON LINE** key can be used to turn output to the main outs ON and OFF.

Enabling the online function

In order to use the online function, the online function must be set to Switchable.

1. Press the **MENU** key on the front panel to open the **MENU** screen.

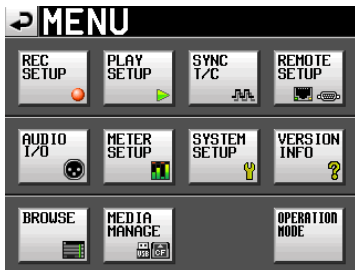
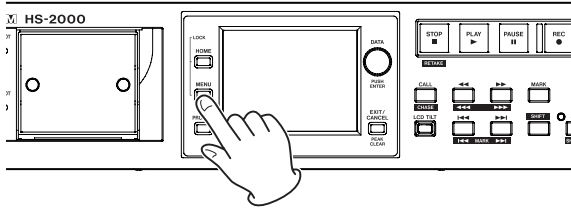

2. Press the **SYSTEM SETUP** button to open the **SYSTEM SETUP** screen.

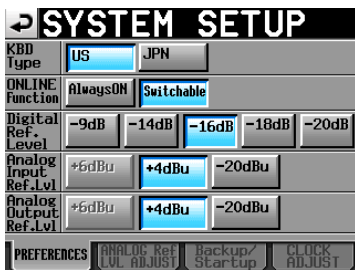

3. Touch the **Switchable** button to enable switching the **ONLINE** Function (default value: Switchable). When the online function setting is **AlwaysON**, online playback mode is always enabled and the **ON LINE** key stays lit to indicate this status.

Switching the online playback mode

When the online function can be changed (**ONLINE** Function set to Switchable), do one of the following to turn online playback on/off.

- Press the **ON LINE** key on the front panel:

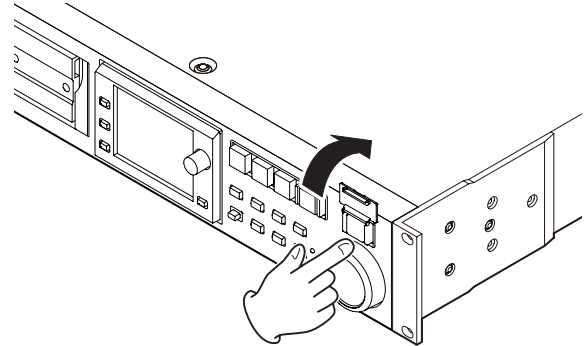

- Send an **ONLINE** event by parallel control
- Send an **ONLINE** command by RS-232C serial control
- Press the **ON LINE** key on a TASCAM RC-HS32PD or RC-HS20PD remote control (sold separately)

When using a TASCAM RC-HS32PD remote control (sold separately), press the player **A ON LINE** key to turn online playback ON/OFF.

When online playback mode is turned ON/OFF, the following occurs.

- When online playback mode is turned ON, the **ONLINE** icon appears red at the top of the Home Screen.
- When online playback mode is turned OFF, the **ONLINE** icon does not appear at the top of the Home Screen.

Outputs during online playback

The relationships between online playback mode and sound outputs are as follows.

Online playback mode	OFF	ON
ANALOG OUT LINE	×	○
DIGITAL OUT LINE	×	○
MONITOR ANALOG OUT	○*	○*
PHONES	○*	○*
RC-HS32PD/RC-HS20PD (headphones, speakers)	○*	○*

*The monitoring signal is always output.

CAUTION

When the **ONLINE** Function item is set to **AlwaysON**, sound is always output from all connectors.

TIP

By turning the **Monitor Mute by Online** item (**AUDIO I/O** screen **SETUP** page) ON, you can enable monitoring output to be turned OFF automatically when online playback mode is ON. (For details about the **Monitor Mute by Online** item, see "Setting audio signal inputs and outputs (SETUP page)" on page 110.)

13 – Other functions

Flash start function

Use the flash start function to instantly start playback of takes that have been designated in advance. A maximum of 100 takes can be started instantly using a keyboard or an external device connected to one of the unit's remote connectors (**REMOTE** and **PARALLEL**).

Setting the flash key function

1. Press the **MENU** key on the front panel to open the **MENU** screen.

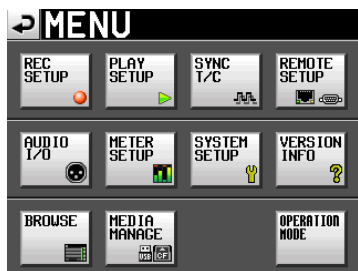
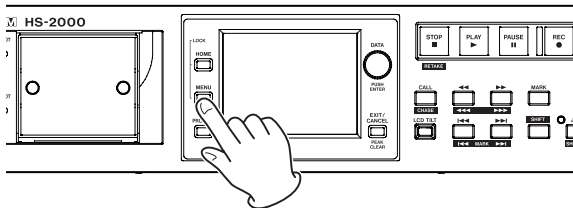

2. Touch the **REMOTE SETUP** button to open the **REMOTE SETUP** screen.

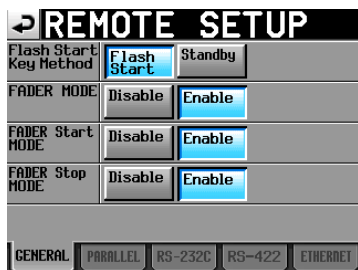

On the **GENERAL** page, set what happens when a flash start key is pressed, and set the fader functions when using a TASCAM RC-HS32PD/RC-HS20PD remote controller (sold separately). For details, see "GENERAL page (Remote settings)" on page 106.

Selecting the flash page

1. In take mode, select the session that you want to play back. (See "Loading sessions" on page 43.) In playlist mode, select a playlist. (See "Loading playlists" on page 83.)
2. After touching the flash page operation/display knob on the Home Screen, use the **DATA** dial to select the page that contains the files or entries that you want to play. The first 96 (RC-HS32PD) or 100 (RC-HS20PD) numbered takes or entries in the selected session or playlist can be played back using flash start.

RC-HS32PD

Page number	Take/entry number
1	1-32
2	33-64
3	65-96

RC-HS20PD

Page number	Take/entry number
1	1-20
2	21-40
3	41-60
4	61-80
5	81-100

3. Press a flash start key to immediately start playback of the take or entry that corresponds to that key.

NOTE

- When using a TASCAM RC-HS32PD remote controller (sold separately), file names (or the first parts of long file names) appear on the keys, making it easy to check the files.
- When using a TASCAM RC-SS20 remote controller (sold separately), you can flash start the first 20 numbered takes or entries.
- When using a computer keyboard, you can flash start the first 12 numbered takes or entries.

Flash start playback

When the Flash Start Key Method is set to Flash Start, touching a flash start key causes the corresponding take or file to start playback instantly.

Standby playback (only with RC-HS32PD remotes)

1. When the Flash Start Key Method item is set to Standby, press a flash start key when stopped to put the take or file that corresponds to that key into playback standby. That key blinks yellow when in playback standby.
2. Then, press the **PLAY** key to start playback. That key lights green during playback.
3. During playback, touching another flash start key causes the corresponding take or entry to be cued for playback (without stopping the currently playing entry). That key will light yellow.
4. Press the **PLAY** key to start playback of that entry. To cancel standby, touch the key for the cued take (yellow key) again.

Operation using a computer keyboard

You can control this unit by connecting an IBM-PC-compatible keyboard with a PS/2 or USB interface to the appropriate connector on its front panel of the unit. A variety of operations are possible, but using the keyboard is especially useful when inputting names.

Setting the keyboard type

Set the type of keyboard connected (US or Japanese) on the **PREFERENCES** page of the **SYSTEM SETUP** screen. (See "PREFERENCES page" on page 112.)

Using a keyboard to input names

You can edit and input characters for the following items in the same way as inputting characters on a computer.

- Project names (See "Editing project names" on page 40.)
- Session names (See "Editing the name of the first session" on page 41 and "Creating new sessions" on page 42.)
- Take names (See "Editing take names" on page 77.)
- The first half of the Next Take name
- The letter in the second half of the Next Take name

You can also use it to enter numbers for the following items.

- T/C USER BITS
- START TIME
- Marks
(See "Editing mark positions" and "Editing mark names" on page 125.)
- Manual locate points
(See "Manual locate function" on page 125.)
- Timecode offsets
(See "SYNC page" on page 104.)
- Playlist names
(See "Creating a new playlist" on page 82 and "Saving playlists" on page 94.)
- AES31 file names
(See "Creating new AES31 editing information" on page 54.)
- Playlist entry names
(See "Editing entry names" on page 88.)
- Bounce file names
(See "Bouncing" on page 69.)

13 – Other functions

Setting the type of character to input:

In the same manner as with a computer, use the Shift and Caps Lock keys to set the letter case or type of character to input.

Inputting characters:

Use number, letter and symbol keys to input them directly.

Moving the cursor:

Use the ←/→ keys.

Use the HOME/↑ key to move the cursor to the beginning.

Use the END/↓ key to move the cursor to the end.

Erasing characters:

Use the Delete key to erase the character at the cursor position. Use the Backspace key to erase the character before the cursor position.

Inserting characters:

Input the characters at the desired position.

CAUTION

- The following symbols and punctuation marks cannot be used in names:
 \ / : * ? " < > |
- The letter in the second half of the next take name can only be an uppercase alphabet letter.

List of keyboard operations

In addition to inputting names, a keyboard can be used to control the transport and perform various other operations. The following is a summary of keyboard key functions.

Keyboard	Function
F1 key	Same as ◀◀ key
F2 key	Same as ▶▶ key
F3 key	Same as CALL key
F4 key	Same as STOP key
F5 key	Same as PLAY key
F6 key	Same as PAUSE key
F7 key	Turn Auto Cue ON/OFF
F8 key	Same as REC key
F9 key	Turn Auto Ready ON/OFF
F10 key	Turn Repeat Mode ON/OFF
F11 key	Change Play Mode
F12 key	N/A
CTRL + F1 key	FLASH 1
CTRL + F2 key	FLASH 2
CTRL + F3 key	FLASH 3
CTRL + F4 key	FLASH 4
CTRL + F5 key	FLASH 5
CTRL + F6 key	FLASH 6
CTRL + F7 key	FLASH 7
CTRL + F8 key	FLASH 8
CTRL + F9 key	FLASH 9
CTRL + F10 key	FLASH 10
CTRL + F11 key	FLASH 11
CTRL + F12 key	FLASH 12

Network functions (FTP/telnet/VNC)

FTP (file transfer protocol)

By using an FTP client application, you can transfer files between this unit and a computer. Connect to this unit and login in the same way as with other FTP servers. After connecting and logging in, "A:", "B:" and "C:" will appear in the root directory. These correspond to the unit's CF1 and CF2 slots and USB port. If a slot or port does not have a card or flash memory, the corresponding "A:", "B:" or "C:" will appear empty.

NOTE

- To display Japanese, use an FTP application that supports Unicode.
- Always set the maximum number of simultaneous transfers of the FTP client application to "1". If not set to "1" files cannot be transferred properly.
- For information about FTP client applications that have been confirmed to work properly with this unit, please contact TASCAM customer support.

• Necessary settings for FTP connection

The following settings are necessary for connecting to this unit by FTP.

IP address:	This unit's IP address is shown in the IP Address field of the REMOTE SETUP screen ETHERNET page.
Port number:	21
User name:	HS-2000 (cannot be changed, case sensitive)
Password:	HS-2000 (default, case sensitive) This setting can be changed by using the Password Change button on the REMOTE SETUP screen ETHERNET page.

NOTE

- The number of simultaneous connections is "1".
- Depending on the FTP client application, two simultaneous connections with this unit might be possible, but files might not be transferred correctly, so we recommend that you do not use two or more simultaneous FTP connections with this unit.
- FTP connections cannot be made when **EXTERNAL Control** has been set to **LOCK** on the Lock Setup screen.
- Likewise, setting this to **LOCK** will end any active FTP connection.
- Changing any settings on the **REMOTE SETUP** screen of the **ETHERNET** page will also end any active FTP connection.

• Working with files using an FTP client application

1. Read files from the unit
You can read files from this unit at any time.
2. Add new files to the unit
You can add files to this unit at any time.
When recording, if you add BWF or WAV files to the current session, they will be shown in the list with existing files, recorded files and added files in that order.
3. Overwrite existing files on the unit
You can only overwrite the current take when the unit is stopped.
You cannot overwrite a take that is in use on the playlist mode entry editing screen. You can overwrite other files at any time.
However, when the **PLAY SETUP** screen **GENERAL** page Play Mode setting is All Take, you might not be able to overwrite the take following the current take depending on the timing.

CAUTION

- In playlist mode, if you overwrite a take that has been added to a playlist as an entry, a "?" will be shown for the corresponding entry on the **ENTRY** and **ASSIGN** screens, and that file will be ignored for playback. You must add overwritten files as entries to enable them to be played back.
- In on-air mode, if you overwrite a file shown in the on-air list screen, the corresponding take will be unchecked and the file will be ignored for playback.
- In on-air mode, when the following rebuild confirmation message is shown, touch **OK**. When you rebuild all takes will be enabled for playback (checked), so deselect any that you do not want to be played back.
- If overwriting causes the size, number of channels, bit-rate or sampling frequency of an audio file to be different from the previous file, inconsistencies could occur in the existing timeline or playlist. If such an inconsistency occurs, an error message will appear when you start playback.
- Do the following to eliminate the inconsistency and stop the error message from occurring.

Timeline mode	Erase the affected region.
Take mode	Delete the affected take from the CF card.
Playlist mode	Add the overwritten file as an entry.
On-air mode	Use the REBUILD button on the Home Screen pull-down menu to rebuild the file structure.
- Do not overwrite an existing audio file with a file that uses a different sampling frequency. This could result in an unresolvable error condition.

13 – Other functions

4. Delete a file on the unit

The current take can be deleted only when the unit is stopped.

Files other than the current take can be deleted at any time.

Deleting files will cause inconsistencies between the system files and audio files, so it is necessary to rebuild after deleting files.

- After deleting a file (and stopping playback or recording), the following rebuild confirmation message will appear. Touch **OK** to rebuild.



- If you do not rebuild, inconsistencies between the system files and audio files will occur and the following message will appear.



- When rebuilding becomes necessary,  icons will appear on the following buttons.
Touch the **REBUILD** button, which is found in several menus, to rebuild the session.
 - File name display button on the Home Screen
 - **MENU** button on the **PROJECT** screen
 - **REBUILD** buttons in various menus

5. Add a new folder to this unit

You can add a new folder to this unit at any time.

6. Delete a folder from this unit

You can only delete the current project/session folder when stopped.

You can delete any folder other than the current project/session folder from this unit at any time.

7. Edit the names of files/folders on this unit

You cannot edit the names of files/folders on this unit.

CAUTION

If you work with files/folders using FTP during recording, you will not be able to retake (erasing the last recorded region/take).

Remote control by Telnet

Remote control of this unit is possible over Ethernet via port 23 using Telnet.

• Necessary settings for Telnet connection

The following settings are necessary for connecting to this unit by Telnet.

IP address :	This unit's IP address is shown in the IP Address field of the REMOTE SETUP screen ETHERNET page.
Port number :	21
Password:	HS-2000 (default, case sensitive) This setting can be changed by using the Password Change button on the REMOTE SETUP screen ETHERNET page.

• Connecting to the unit by Telnet

1. After connecting with this unit by Telnet using the above IP address and port number, press the computer Enter key.
2. When "Enter Password" appears on the Telnet console, input the above password and press the Enter key.
3. When login succeeds, "Login Successful" appears on the Telnet console. Input "exit" and press the Enter key to end the Telnet connection.

NOTE

- 2 simultaneous Telnet connections are possible.
- Telnet connections cannot be made when **EXTERNAL Control** has been set to **LOCK** on the Lock Setup screen. Likewise, setting this to **LOCK** will end any active Telnet connections.
- Changing any settings on the **REMOTE SETUP** screen of the **ETHERNET** page will also end any active Telnet connection.
- For information about this unit's Telnet command protocol, please contact TASCAM customer support.

VNC (virtual network computing)

By using a VNC viewer application, you can view and operate the contents of this unit's LCD screen on a computer.

In the VNC viewer application, you can use a mouse to do the following operations.

Mouse left click:	Same as touching the unit's LCD.
Mouse wheel click:	Same as pressing the unit's ENTER key.
Mouse wheel operation:	Same as using the unit's DATA dial.
Mouse wheel push and turn:	Same as using the unit's DATA dial while pushing it to make large setting changes (COARSE mode operation).

In addition, when the VNC viewer application is active, you can conduct the following operations using the computer keyboard.

F1–F12 keys:	These work the same as an external keyboard connected to the unit. For details see the "List of keyboard operations" in "Operation using a computer keyboard" in "12 – Other functions" of this unit's manual.
HOME key:	This works the same as this unit's HOME key and opens the Home Screen. Press the End key while pressing and holding the Home key to open the LOCK SETUP screen.
End key:	This works the same as this unit's MENU key and opens the MENU screen. Press the End key while pressing and holding the Home key to open the LOCK SETUP screen.
Page Down:	This works the same as this unit's PROJECT key and opens the PROJECT screen.
Cursor ↑ key:	This works the same as turning this unit's DATA dial right.
Cursor ↓ key:	This works the same as turning this unit's DATA dial left.
Character input keys:	Use to input characters when a keyboard screen appears on the unit.

• Necessary settings for VNC connection

The following settings are necessary for connecting to this unit using a VNC viewer application.

- IP address: This unit's IP address is shown in the IP Address field of the **REMOTE SETUP** screen **ETHERNET** page.
- Password: HS-2000 (default, case sensitive)
This setting can be changed by using the Password Change button on the **REMOTE SETUP** screen **ETHERNET** page.

- Changing any settings on the **REMOTE SETUP** screen of the **ETHERNET** page will also end any active VNC connection.
- For information about VNC viewer applications that have been confirmed to work properly with this unit, please contact TASCAM customer support.
- When files are being transferred over FTP or when the system sampling frequency is 88.2, 96, 176.4 or 192 kHz, VNC viewer application display and operation will not be smooth.

NOTE

- Multiple simultaneous VNC connections are not possible.
- When **EXTERNAL Control** has been set to **LOCK** on the Lock Setup screen, display is possible using a VNC viewer application, but VNC cannot be used to control the unit.

14 – Timecode synchronization

In this chapter, we explain the use of timecode synchronization.

This unit's playback and recording can be synchronized with SMPTE timecode input through the **TIMECODE INPUT** connector on the rear panel or the internal timecode generator ("master timecode" hereafter).

Time code synchronization differs according to the operation mode.

Playback synchronized with timecode

Timeline mode

In timeline mode, playback can be synchronized with master timecode.

When set to do so, playback synchronizes with master timecode when it starts.

Take mode

Timecode synchronized playback is not supported in this mode.

Playlist mode

Timecode synchronized playback is not supported in this mode.

On-air mode

Timecode synchronized playback is not supported in this mode.

Recording synchronized with timecode

Timeline mode

Recording can be synchronized with master timecode in timeline mode.

When recording with timecode synchronization, master timecode is captured the instant that recording starts, and recording starts on the timeline from that timecode time.

Take mode

Recording cannot be synchronized with master timecode in this mode.

However, the timecode from the internal timecode generator is captured at the beginning of recording as the file starting time.

Playlist mode

In playlist mode, recording is not possible regardless of the timecode synchronization status.

On-air mode

In on-air mode, recording is not possible regardless of the timecode synchronization status.

Basic operation with timeline synchronization

1. In timeline mode, load the session that you want to record or play back.
2. Either of the following operations will enable timeline synchronization.
 - While pressing and holding the **SHIFT** key, press the **CALL [CHASE]** key on the front panel.
 - On the **SYNC** page of the **SYNC T/C** screen, set TC Chase to ON. The **CHASE** indicator will appear in place of the TC indicator on the Home Screen.
3. Press **PLAY** key to start synchronized playback or **PLAY** and **RECORD** keys to start synchronized recording. The **CHASE** indicator on the Home Screen appears green.
4. Press the **STOP** key during recording or playback with timecode synchronization to stop the transport. The **CHASE** indicator on the Home Screen blinks when stopped.
5. To resume recording and playback with timecode synchronization, repeat steps 3 and 4.
6. Either of the following operations will disable synchronization.
 - While pressing and holding the **SHIFT** key, press the **CALL [CHASE]** key on the front panel.
 - On the **SYNC** page of the **SYNC T/C** screen, set TC Chase to OFF.

NOTE

In either case, recording or playback will continue without interruption. The TC indicator will appear in place of the **CHASE** indicator on the Home Screen.

Timecode offset

You can set an offset for master timecode synchronization. By doing so, you can synchronize to master timecode for playback with a set time difference (see “**SYNC** page” on page 104).

Rechase

This unit continues to monitor master timecode even after synchronized playback starts. Should the playback time of this unit and the master timecode become unsynchronized for any reason, the unit can “rechase” the timecode. You can set whether or not the unit uses rechase and the degree of the discrepancy that must occur before rechasing (see “**SYNC** page” on page 104).

CAUTION

During synchronized recording, this unit only synchronizes to the master timecode once at the start of recording. There is no rechase function as there is with synchronized playback.

15 – Importing files recorded by other devices

This unit can import and play audio files that meet the following requirements.

In addition, files created by other TASCAM HS series units can be played back as is if they meet the following conditions:

File format:	BWF/WAV
Sampling frequency:	44.1, 47.952*, 48, 48.048**, 88.2, 96, 176.4, 192 kHz *48kHz-0.1% pull-down **48kHz+0.1% pull-up
Quantization bit rate:	16/24-bit
Number of tracks:	1 or 2

CAUTION

Since the sampling frequency (sampling rate) that can be played back is fixed by the project, the file sampling frequency must match the set project sampling frequency (Fs) value.

Preparation before importing

Check the sampling frequency (sampling rate) of the file(s) that you want to import in advance.

1. Select a project with an Fs value that matches the sampling frequency of the file(s) or create a new project with the same sampling frequency as the file(s) using the Fs item on **CREATE PROJECT** screen 1/3.



CREATE PROJECT screen 1/3

2. Create a session as necessary.

NOTE

For details about creating projects and sessions, see "Project operations" on page 38 and "Session operations" on page 42.

3. Make a note of the names of the project and session that you want to use for importing the file. In this example, the name of the project is "Project_i" and the name of the session is "Session_i".
4. Confirm that the indicator for the slot where the CF card is inserted is not blinking rapidly and eject the card.
5. Insert that CF card into the card slot of a computer, for example. If this card was formatted by this unit, it will be recognized by the computer as a drive named HS-2000. In this example, the drive name HS-2000 is used.

6. Copy the audio file(s) that you want to import into the "Session_i" folder inside the "Project_i" folder on the HS-2000 drive.

CAUTION

Do not eject a CF card while data is being written to it. Doing so could cause data on the card to be damaged or even become unreadable. For further information, please see the manual for your computer, card reader or other device being used for this purpose.

7. After copying completes, eject the card from the computer slot, for example.

Using imported files on this unit

1. Insert the CF card that contains the copied file(s) into one of this unit's card slots.
2. Press the **PROJECT** key on the front panel to open the **PROJECT** screen, and touch the → button to the right of the project that contains the imported file (Project_i) to open the session selection screen.
3. Select the session that contains the imported file (Session_i). When selected, it appears yellow.
4. Touch the **MENU** button to open the pull-up menu, and touch the **LOAD** button.



The imported file is now recognized as a take.

5. You can play the file by adding it to the timeline using the timeline mode editing functions, you can play the file in take mode, or you can add it to a playlist and play it back in playlist mode. For more information, see "7-Timeline mode" on page 48 for the timeline mode editing functions, "8-Take mode" on page 70 for details about take mode playback, and "9-Playlist mode" on page 81 for details about playlist mode playback.

If the operation of this unit becomes irregular, please check the following things before requesting repair. If the following measures do not resolve the problem, contact the store where you purchased the device or a TEAC Repair Center.

● **Power does not turn on.**

- Confirm that the power plug, for example, is connected completely.

● **Media is not recognized.**

- Confirm that the card is securely inserted into the card slot.
- Pause recording or playback once.

● **The unit controls do not function.**

- Is the panel lock function ON?

● **Playback is not possible**

- Confirm that the audio file's sampling frequency (44.1/47.952/48/48.048/88.2/96/176.4/192kHz) and quantization bit rate (16/24) are compatible.
- Confirm that the sampling frequency of the project and the audio file(s) are the same.

● **There is no sound.**

- Reconfirm the connections of your monitoring system and check the volume of your amplifier.
- When using a TASCAM RC-HS32PD/RC-HS20PD remote controller (sold separately), confirm that the fader is not lowered.
- If you cannot hear the input signal, turn input monitoring ON.
- If you cannot hear the playback signal, turn input monitoring OFF.
- Check the online function and online playback mode settings.
- Confirm that Monitor Mute by Online is set to OFF on the SETUP page of the AUDIO I/O screen. If it is ON, the monitoring signal will be muted when online.

● **Recording is not possible.**

- Reconfirm connections.
- Adjust the recording levels.
- If the CF card does not have sufficient space, erase unneeded data to increase the amount of available space or use a different card.
- If the maximum number of recordable takes or the maximum take number has been reached, change the recording session.
- If the total number of items in the folder, including files and subfolders/directories, is too large, change the recording session.

● **Setting changes are not remembered.**

- This unit backs up settings whenever the CF card selection is changed, whenever a project, session or a take is loaded, and whenever playback or recording occurs. After startup, if none of these actions is conducted, settings might not be backed up even if they are changed.

● **I hear noise.**

- Confirm that none of the cables have problems.

● **The touch panel does not work properly.**

- Do not use commercially-available protective film for LCD screens on the touch panel.
- Confirm that the panel lock function is not engaged and locking the display.

● **I cannot create a new project.**

- Confirm that a project with the same name does not already exist.
- If the amount of space remaining on the CF card is insufficient, a new project cannot be created. Erase unneeded data and then create the project.

17 – Messages

The following is a list of messages that the HS-2000 shows in pop-up windows under certain circumstances. Refer to this list to learn more about the messages and how to respond to them.

The first messages in the list have contents that vary depending on the situation. The subsequent messages are listed in alphabetical order.

Message	Details and responses	Notes
MM "vvvvvvvv" NUM OF PROJECTS: p USED SIZE: u FREE SIZE: f TOTAL SIZE: t	This shows information about a CF card.	MM = CF1 or CF2 vvvvvvvv = volume level p: number of projects u: capacity used f: capacity unused t: total capacity of card
MM DEVICE ERROR	The medium cannot be recognized.	MM = CF1, CF2 or USB Memory
MM Format failed	An error occurred during formatting, and formatting could not be completed.	MM = CF1, CF2 or USB Memory
MM has no projects. Please create a project.	The CF card does not have any projects.	MM = CF1 or CF2
MM is not available	That medium is not available.	MM = CF1, CF2 or USB Memory
MM is not usable	You cannot copy.	MM = CF1, CF2 or USB Memory
MM MEDIUM ERROR	The unit failed to read the medium.	MM = CF1, CF2 or USB Memory
MM formatting not optimal for Recording.	Since the CF card was not formatted in this unit, proper recording and playback operations cannot be guaranteed. You should reformat the card.	MM = CF1 or CF2 This appears when recording is started to a card that is formatted with a cluster size that is smaller than the standard of this unit.
MM formatting not optimal for Recording/Search. Format this card?	Since the CF card was not formatted in this unit, proper recording and search operations cannot be guaranteed. You should reformat the card.	MM = CF1 or CF2 This appears when a card that is formatted with a cluster size that is smaller than the standard of this unit is loaded.
MM Read Error	An error occurred when reading the medium.	MM = CF1, CF2 or USB Memory
MM to MM' Copy failed.	Copying all data from the first medium to the other was not possible.	MM = CF1, CF2 or USB Memory MM' = CF1, CF2 or USB Memory
MM unrecognized format Please Format this card.	This medium has been formatted in a format other than FAT. Format it with this unit.	MM = CF1, CF2 or USB Memory
MM unsupported type	This medium does not meet the specifications required by the system, so it cannot be used.	MM = CF1, CF2 or USB Memory
MM Write Error	An error occurred when writing to the card.	MM = CF1, CF2 or USB Memory
Copy N selected session(s) to MM?	Confirm that you want to export the selected sessions.	N = number selected MM = CF1 or CF2
Copy N selected Take(s) to MM?	Confirm that you want to export the selected takes.	N = number selected MM = CF1 or CF2
"nnn": "eeeeeee" "ttttttt" fs/bit/FileMode/NumOfTracks Entry LENGTH: *h*m**s**f START T/C: hh:mm:ss.ff	This shows information about an entry.	nnn: entry number eeeeeeee: entry name ttttttt: take name fs: sampling frequency bit: bit rate FileMode: MONO or POLY NumOfTracks: number of tracks Entry LENGTH: length of entry START T/C: timecode of start of entry
nnn: NNNNNNNN cannot be found.	The take with the number and name cannot be found.	nnn: take number NNNNNNNN: take name
"pppppppp" SESSION: n Fs: f TIMECODE: t	This shows information about a project.	pppppppp = project name n: number of sessions f: sampling frequency t: timecode frame type
"sssssss" TAKES: n Fs: f TOTAL SIZE: u TOTAL TIME: t	This shows information about a session.	sssssss = session name n: number of takes f: sampling frequency u: capacity used t: total time of all takes

Message	Details and responses	Notes
"ttttttt" date fs/bit/FileMode/NumOfTracks SIZE: u LENGTH: *h*m*s*f	This shows information about a take.	ttttttt = take name date: year/month/day hour:minute fs: sampling frequency bit: bit rate FileMode: MONO or POLY NumOfTracks: Number of tracks u: capacity used
"ttttttt" START T/C: **. **. **. ** END TC: **. **. **. ** FRAME TYPE: **F	This shows information about a take.	ttttttt = take name START T/C: timecode of start of file END T/C: timecode of end of file FRAME TYPE: frame type
<AES31 ADL Info> "ffffff" Size: **MB yyyy/mm/dd hh: mm	This shows information about an AES31 editing data file.	ffffff = editing information file name
Bounce Selected Area to file? "ffffff"	The selected region will be bounced as "ffffff".	ffffff = file name
Canceled	The operation was canceled.	
Cannot Change Now Currently **	This item cannot be changed during playback, online operation, timecode chase or recording or when on-air is ON.	** = Playing, ONLINE, ON AIR, Chasing TC or Recording
Cannot Change Now Fixed in current Fs.	This cannot be changed with the current sampling frequency.	
Cannot Change Now Fixed in current mode.	In the current mode, settings are fixed and cannot be changed.	
Cannot Change Now Inc.Play cannot set to ON while Play Inhibit Time is Inf.	Since Play Inhibit Time is set to Inf, Inc.Play cannot be turned ON.	
Cannot Copy. "ttttttt" already exists in current session.	When assigning a take from another session to an entry, that take is copied to the current session. In this case, a file with the same name as the copied take already exists in the current session. RENAME button: change the name and copy the file CANCEL button: do not copy	ttttttt = name of take to copy
Cannot Copy. Destination Project is different Fs.	Copying is not possible because the sampling frequency of the destination project is different.	
Cannot Copy File. "ffffff" already exists in Destination.	Copying is not possible because the selected file already exists in the destination.	ffffff: file name
Cannot Copy Folder. "ffffff" already exists in Destination.	Copying is not possible because the selected folder already exists in the destination.	ffffff: folder name
Cannot Copy for Insert. "ffffff" already exists in current Session.	Cannot copy for insertion because the selected file already exists in the current session.	ffffff: file name
Cannot Copy for Paste. "ffffff" already exists in current Session.	Cannot copy for pasting because the selected file already exists in the current session.	ffffff: file name
Cannot Copy. Selected Take already exists in Copy destination.	Copying is not possible because the selected take already exists in the destination.	
Cannot Copy. Source folder and Destination folder are same.	Copying is not possible because the source and destination folders are the same.	
Cannot Copy. Destination folder is sub-folder of source folder.	Copying is not possible because the destination folder is a sub-folder of the source folder.	
Cannot create more than 100 projects	The maximum number of projects that can be created has already been reached, so a new project cannot be created.	

17 – Messages

Message	Details and responses	Notes
Cannot create new mark point. Mark point already exists at the same timestamp.	You tried to create a mark at a time where a mark already exists. You cannot create a mark at the same time as another mark.	
Cannot create new project. Media Full.	The CF card does not have enough space, so you cannot create a new project.	
Cannot Divide. "ttttttt_a" or/and "ttttttt_b" already exist in current Session.	Cannot divide because a file with the same name already exists in the current session.	ttttttt: take name
Cannot Edit. System limit reached.	Cannot edit because there is not enough available space for the working memory needed to manage the timeline region or edit history.	
Cannot edit this mark point. Mark point already exists at the same timestamp.	Since a mark already exists at the same time, the mark cannot be edited.	If the time differs at the sub-frame level, which is not shown on-screen, editing is possible even when the time is the same at the frame level and higher.
Cannot execute bounce. Media Full.	Bouncing is not possible because the media does not have enough space.	
Cannot execute bounce. Bounce file size is over 2GB.	Bouncing is not possible because the resulting file size after the bounce would exceed 2 GB.	
Cannot execute combine. "aaaaaaa" "bbbbbbbb" These property are not matched.	Cannot combine because the properties of the two takes are different.	aaaaaaa = name of first take to be combined bbbbbbbb = name of second take to be combined
Cannot execute combine. Combined file size is over MMM.	Cannot combine because the combined file size will exceed the Max File Size on the Format page on the REC SETUP screen.	MMM = 640MB, 1GB or 2GB
Cannot execute combine. Media Full.	Cannot combine because the media does not have enough open space.	
Cannot execute. File property is not matched to current project.	Cannot execute because file properties are different from those of the current project.	
Cannot execute. Media Full.	Cannot execute because the media does not have enough space.	
Cannot Export. Not enough space on MM	There is not enough available space on the export destination CF card.	MM = CF1 or CF2
Cannot Export. Destination Project is different Fs.	Cannot export because the sampling frequency of the copy destination is different.	
Cannot Export. Folder already exists on MM. Overwrite session?	A session with the same name already exists on the export destination. Confirm that you want to overwrite that session?	MM = CF1 or CF2
Cannot Export. Selected Take already exists in Export destination.	Cannot export because a take with the same name already exists on the export destination.	
Cannot increment Take. Interval is too short. Or Media almost full	Less than 4 seconds have passed since pressing the REC key or the CF card does not have enough space, so starting recording of the next take is not possible.	
Cannot increment Take. System limit reached, Please make new session.	The total number of items in the folder, including files and folders/directories, is too large, so starting recording of the next take is not possible.	
Cannot make more than 1000 sessions.	The maximum number of sessions has already been reached, so a new session cannot be created.	
Cannot make new Session. Media Full.	The CF card does not have enough space, so you cannot create a new session.	
Cannot RECORD. (Internal state error)	Something is preventing recording.	
Cannot RECORD. ABS time is over 24h	The ABS time in timeline mode exceeds 24 hours so recording cannot be started.	
Cannot RECORD. Media Full.	The media does not have enough free space, so you cannot start recording.	

Message	Details and responses	Notes
Cannot RECORD Play Fs setting is not OFF. Please change Play Fs to OFF.	Recording is not possible because Play Fs is set to Pull-down or Pull-up.	
Cannot RECORD System limit reached. Please make new Session.	The total number of items in the folder, including files and folders/directories, is too large, so starting recording is not possible.	
Cannot RECORD. Take limit reached. Please change to another Session	Since the maximum number of recordable takes or maximum take number has been reached, recording is not possible. Change the session.	
Cannot Retake. No Recent REC history.	You cannot retake until at least one recording has been made in this session.	
Cannot set Mark point in ON AIR Mode.	Marks cannot be added in on-air mode.	
Cannot set Mark point. Mark limit reached.	You cannot create more than 99 marks.	
Cannot turn Fs convert On. D-In is already Master Clock.	You tried to turn the sampling rate converter on for the digital input that is set as the master clock.	
Cannot use Bridge file because it is illegal.	Cannot use the bridge file because it is not correct.	
Capture BC\$ Time to ALL? BC\$STANDBY -> Start BC\$END -> End	Confirm that you want to use the BC\$STANDBY and BC\$END mark times for all entries.	
Capture BC\$ Time? BC\$STANDBY -> Start BC\$END -> End	Confirm that you want to use the BC\$STANDBY and BC\$END mark times.	
CFn(vvvvvvvv) Fs: fs USED SIZE: u FREE SIZE: f TOTAL SIZE: t	This shows information about the CF card in on-air mode.	n = 1 or 2 vvvvvvvv = volume level fs: the current Fs setting u: capacity used f: capacity unused t: CF card total capacity
CF1 Media Full. CF1: Stopped. CF2: Still RECORDING.	Since CF card 1 does not have enough open space, recording to it has stopped. Recording to CF card 2 continues.	This occurs when REC Mode is set to Mirror.
CF2 Media Full. CF1: Still RECORDING. CF2: Stopped.	Since CF card 2 does not have enough open space, recording to it has stopped. Recording to CF card 1 continues.	This occurs when REC Mode is set to Mirror.
CFn not recommended for Recording/Search. (not Ultra DMA)	This CF card does not meet the specifications required by the system, so using it for recording/searching is not recommended.	n = 1 or 2
CF1 Record Error. CF1: Stopped. CF2: Still RECORDING.	Since an error occurred during recording to CF1, recording to it has stopped. Recording to CF card 2 continues.	This occurs when REC Mode is set to Mirror.
CF2 Record Error. CF1: Still RECORDING. CF2: Stopped.	Since an error occurred during recording to CF2, recording to it has stopped. Recording to CF card 1 continues.	This occurs when REC Mode is set to Mirror.
Change Fs to nnkHz?	The system sampling frequency will be switched to the frequency shown.	nn: sampling frequency
Clear Current EDL and Import All Takes?	Confirm that you want to clear the current AES31 editing data and import all the takes.	
Clear In/Out Point?	Confirm that you want to clear the IN and OUT points.	
Combine these Takes? "aaaaaaa" "bbbbbbbb"	Confirm that you want to combine the two takes.	aaaaaaa = name of first take to be combined bbbbbbbb = name of second take to be combined
Completed	The operation has completed.	
Confidence Monitor is not available while REC Mode is Mirror.	When REC Mode is set to Mirror, confidence monitoring cannot be turned ON.	
Confidence Monitor is not available with current Fs.	Confidence monitoring cannot be turned ON because it is not supported with the current Fs setting.	

17 – Messages

Message	Details and responses	Notes								
CONFIRM QUICK FORMAT MM & Create Project? "pppppppp" "ssssssss" fs/bit/FrameType/NumOfTracks	Reconfirm that you want to conduct both quick-formatting and project creation at once.	MM = CF1 or CF2 pppppppp = name of project created ssssssss = name of first session created								
Copy MM to MM'? This will erase all data on MM'.	Confirm that you want to copy all data between media.	MM = CF1, CF2 or USB Memory MM' = CF1, CF2 or USB Memory								
Copy selected Folder? "nnnnnnnn"	Confirm that you want to copy the selected folder.	nnnnnnnn = name of folder to be copied								
Copy selected File? "nnnnnnnn"	Confirm that you want to copy the selected file.	nnnnnnnn = name of file to be copied								
Copy selected Take?	Confirm that you want to copy the selected take.	n = number of takes When "n" is 2 or more, "Takes"								
Copying Folder.	The folder is being copied.									
Copying File.	The file is being copied.									
Copying Take.	The take is being copied.	When 2 or more, "Takes"								
Create EDL failed.	Failed to create an AES31 editing data file.	EDL = edit decision list								
Create new EDL? "eeeeeeee"	Confirm that you want to create a new AES31 editing data file.	eeeeeeee = AES31 editing data file name EDL = edit decision list								
Create new Playlist? "pppppppp"	Confirm that you want to create a new playlist.	pppppppp = playlist name								
Create new project? "pppppppp" "ssssssss" Fs: **kHz, Frame Type: **F	Confirm that you want to create a new project.	pppppppp = name of project to be created ssssssss = name of first session to be created								
Create Project failed	Failed to create the project.									
Creating EDL.	The AES31 editing data file is being created.	EDL = edit decision list								
Creating Project ...	The project is being created.									
Delete all marks of this type? (Count: N)	Confirm that you want to delete marks of the selected type.	N = number of marks of selected mark type								
Delete N selected marks?	Confirm that you want to delete the selected marks.	N = number of marks								
Delete N selected project?	Confirm that you want to delete the selected project(s).	N = number selected								
Delete N selected session?	Confirm that you want to delete the selected session(s).	N = number selected								
Delete N selected take?	Confirm that you want to delete the selected take(s).	N = number selected								
Delete selected EDL?	Confirm that you want to delete the selected AES31 editing data file.	EDL = edit decision list								
Delete selected playlist?	Confirm that you want to delete the selected playlist.									
Delete this Folder?	Confirm that you want to delete the selected folder.									
Delete this File?	Confirm that you want to delete the selected file.									
Deleting EDL.	The AES31 editing data file is being deleted.	EDL = edit decision list								
Deleting Playlist...	The playlist is being deleted.									
Deleting Folder.	The folder is being deleted.									
Deleting File.	The file is being deleted.									
Deleting Project...	The project is being deleted.									
Deleting Session...	The session is being deleted.									
Deleting Take...	The take is being deleted.									
Digital Input Error (eeeeeeee)	An error occurred with the digital input selected for the input signal.	eeeeeeee = one of the following errors <table border="1"> <tr> <td>Unlocked:</td> <td>not synchronized with system</td> </tr> <tr> <td>no signal:</td> <td>no signal being input</td> </tr> <tr> <td>not audio:</td> <td>Cbit data of input signal is not audio</td> </tr> <tr> <td>unmatched Cbit:</td> <td>other Cbit data is different from actual operation mode</td> </tr> </table>	Unlocked:	not synchronized with system	no signal:	no signal being input	not audio:	Cbit data of input signal is not audio	unmatched Cbit:	other Cbit data is different from actual operation mode
Unlocked:	not synchronized with system									
no signal:	no signal being input									
not audio:	Cbit data of input signal is not audio									
unmatched Cbit:	other Cbit data is different from actual operation mode									
D-In: Fs convert On Cannot select as Master clock.	The sampling rate converter is ON for the digital input that you tried to set as the clock master.									
Directory contents changed. REBUILD required. REBUILD Now?	The directory needs to be rebuilt because its content has been changed.									





Message	Details and responses	Notes
Directory contents changed via FTP. REBUILD required. REBUILD Now?	The directory needs to be rebuilt because the content has been changed via FTP.	
Edit Completed	The editing operation has completed.	
EDL Load completed but there are some wrong regions.	Loading AES31 editing information has completed, but there are some incorrect regions.	
--- error --- INFO WRITING	An error occurred while writing data.	
Export System Backup Data to MM?	Confirm that you want to export system backup data to the CF card.	MM = CF1 or CF2
Exporting session(s).	Confirm that you want to export the session(s).	
Exporting Take(s).	Confirm that you want to export the take(s).	
External Clock Lost, Switched to Internal	Synchronization with an external clock was disrupted, so the internal clock was activated.	
External Clock Regained Switch to External?	Synchronization with an external clock became possible again. Confirm that you want to switch back the external clock.	
EXTERNAL Control Locked	Input through external control connectors is locked to prevent misoperation.	
Folder Copy Failed.	Failed to copy the folder.	
File Copy Failed.	Failed to copy the file.	
--- FORMAT --- Completed	Formatting has completed.	
--- FULL FORMAT --- FORMAT MM? This will erase all DATA on card	Confirm that you want to execute a full format.	MM = CF1, CF2 or USB Memory
--- FULL FORMAT --- Formatting MM...	Full formatting is occurring.	MM = CF1, CF2 or USB Memory
Import All System Backup Data from MM?	Confirm that you want to import all system backup data from the CF card.	MM = CF1 or CF2
Import User Preset Data from System Backup Data on MM?	Confirm that you want to import user preset data from system backup data on the CF card.	MM = CF1 or CF2
Initializing ...	The unit is starting up.	
Last loaded project has no session. Please make new session.	The last selected project does not have any sessions. Create a new session.	
Last loaded project cannot be found. Please select a project.	The last selected project cannot be found. Select a different project.	
Last loaded session cannot be found. Please select a session.	The last selected session cannot be found. Select a session.	
Load Factory Preset?	Confirm that you want to load the original factory settings.	
Load selected playlist? "pppppppp"	Confirm that you want to load the selected playlist.	pppppppp = name of playlist to load
Load selected project? "pppppppp"	Confirm that you want to load the selected project.	pppppppp = name of project to load
Load selected session? "ssssssss"	Confirm that you want to load the selected session.	ssssssss = name of session to load
Load selected take? "ttttttt"	Confirm that you want to load the selected take.	ttttttt = name of take to load
Load User Preset?	Confirm that you want to load the user preset settings.	
Loading File.	The file is loading.	
Loading Playlist ...	The playlist is loading.	
Loading Take ...	The take is loading.	
Loading Session ...	The session is loading.	
Make new Session? "ssssssss" TIMELINE Start Time: **h**m**s**f	Confirm that you want to make a new session.	ssssssss = session name

17 – Messages

Message	Details and responses	Notes
Make Playlist failed	Failed to create a playlist.	
Make session failed	Failed to create a session.	
Making Playlist ...	A playlist is being created.	
Making session ...	A session is being created.	
Mark Point set	A mark has been created.	
Mirror REC is not available. (MM is not available)	Mirror recording is not possible because the CF card cannot be used.	This occurs when REC Mode is set to Mirror. MM = CF1 or CF2
Mirror REC is not available. CF not recommended type for Recording. (not Ultra DMA)	Mirror recording is not possible because the CF card does not meet the specifications required by the system and correct recording cannot be guaranteed.	This occurs when REC Mode is set to Mirror.
Mirror REC is not available. MM formatting not optimal for Recording.	Mirror recording is not possible because the CF card has not been formatted by this unit and correct recording cannot be guaranteed. Format the card with this unit before use.	This occurs when REC Mode is set to Mirror. MM = CF1 or CF2
Mirror REC is not available while Confidence Monitor is ON.	Since confidence monitoring is ON, mirror recording cannot be enabled.	
Network Control Locked	Network control has been locked to prevent misoperation.	
New Session Name must not start with "@"	The session name is not allowed. You cannot use the "@" symbol at the beginning of a session name.	
No Call Point	The call point does not exist. (Playback has not occurred since loading the session or take)	
No Mark Point	You tried to skip marks, but no marks have been added yet.	This disappears automatically after 2 seconds.
Now Working. Do not remove Media.	An operation is being processed. Do not remove the media.	
--- ONLINE Function --- Changes Output Routing. Touch OK to make ONLINE *****.	Changing whether the online function is enabled or disabled changes the audio output signal path.	***** = always ON/switchable
Operation failed.	The operation could not be completed for some reason.	
Operation failed. Cannot find this ***. Please Rebuild.	The designated project/session/take could not be found, so the operation could not be completed. Rebuild the selected item.	*** = name of project, session or take
Operation failed. Internal File/Session limit reached.	The maximum number of sessions that can be created has been reached, so the operation could not be completed.	
Operation failed. Path Name is too long.	The path name has more characters than allowed, so the operation could not be completed.	This appears when making a session or recording would result in a file path name of more than 255 characters. This can occur after using a computer to give projects and sessions long names.
Operation Failed. Unmatched Fs.	Sampling frequency does not match.	
Play Error Buffer underrun	Data reading could not keep up during playback.	
Play Error.	An error occurred during playback.	
Play Error. nnn: NNNNNNNN	A playback error occurred with the take of the number and name shown.	nnn: take number NNNNNNNN: take name
Playlist Import completed but there are some wrong entries.	Importing a playlist has completed, but there are some entries with problems.	
<PlayList Info> "PPPPPPPP" Size: **MB yyyy/mm/dd hh: mm	This shows playlist information.	PPPPPPPP = playlist name
Playlist Load completed but there are some wrong entries.	Loading a playlist has completed, but there are some incorrect entries.	
PLEASE CONFIRM Capture BC\$ Time to ALL? BC\$STANDBY -> Start BC\$END -> End	Reconfirm that you want to use the BC\$STANDBY and BC\$END mark times for all entries.	
PLEASE CONFIRM Change Fs to nnkHz?	Reconfirm that you want to change the system sampling frequency to the Fs value shown.	nn: sampling frequency

Message	Details and responses	Notes
PLEASE CONFIRM --- FULL FORMAT --- FORMAT MM? This will erase all data on card	Reconfirm that you want to full format the media.	MM = CF1, CF2 or USB Memory
PLEASE CONFIRM --- QUICK FORMAT --- FORMAT MM? This will erase all data on card	Reconfirm that you want to quick format the media.	MM = CF1, CF2 or USB Memory
PLEASE CONFIRM Copy MM to MM'? This will erase all data on MM'.	Reconfirm that you want to copy everything between media.	MM = CF1, CF2 or USB Memory MM' = CF1, CF2 or USB Memory
PLEASE CONFIRM Delete this File? "nnnnnnnn"	Reconfirm that you want to delete the selected file.	nnnnnnnn = name of file to delete
PLEASE CONFIRM Delete this Folder? "nnnnnnnn"	Reconfirm that you want to delete the selected folder.	nnnnnnnn = name of folder to delete
PLEASE CONFIRM Delete N selected take?	Reconfirm that you want to delete the selected takes.	N = number selected
PLEASE CONFIRM Export System Backup Data to MM?	Reconfirm that you want to export system backup data to the CF card.	MM = CF1 or CF2
PLEASE CONFIRM Import All System Backup Data? from MM?	Reconfirm that you want to import all system backup data from the CF card.	MM = CF1 or CF2
PLEASE CONFIRM Import User Preset Data from System Backup Data on MM?	Reconfirm that you want to import user preset data from system backup data on the CF card.	MM = CF1 or CF2
PLEASE CONFIRM Load Factory Preset?	Reconfirm that you want to load the original factory settings.	
PLEASE CONFIRM Load User Preset?	Reconfirm that you want to load the user preset settings.	
PLEASE CONFIRM Save current setting to User Preset?	Reconfirm that you want to save the current settings as the user preset settings.	
Project Delete failed.	Failed to delete the project.	
Project Load failed.	Failed to load the project.	
Project Rename failed	Failed to change the project name.	
Project save failed.	An error occurred while saving the project, and saving failed. Touch the CLOSE button to close the pop-up window. The FAT file system might be broken. Format the CF card or use a different one. Formatting will erase all DATA on the card.	
PROJECT screen is not available in Jog Mode	The PROJECT screen cannot be opened when in jog mode.	
PROJECT screen is not available while Recording	The PROJECT screen cannot be opened when recording.	
--- QUICK FORMAT --- FORMAT MM? This will erase all DATA on card	Confirm that you want to quick format the medium.	MM = CF1, CF2 or USB Memory
--- QUICK FORMAT --- Formatting MM...	Quick formatting is occurring.	MM = CF1, CF2 or USB Memory
QUICK FORMAT MM & Create Project? "pppppppp" "sssssss" fs/bit/FrameType	Quick formatting will be executed and a project will be created.	MM = CF1 or CF2 "pppppppp" = name of project created "sssssss" = name of the first session created fs: sampling frequency bit: bit rate Frame Type: frame type
Reading DATA.	DATA is being read.	
Reading Media ...	Media is being read.	

17 – Messages

Message	Details and responses	Notes
Rebuild all Projects?	Confirm that you want to rebuild all projects.	
Rebuild changed Directory?	Confirm that you want to rebuild the changed directory.	This message appears when you touch a REBUILD button with a  mark after changing a file on this unit via FTP or the BROWSE screen.
Rebuild current project and changed Directory?	Confirm that you want to rebuild the current project and changed directory.	This message appears when you touch a REBUILD button with a  mark after changing a file on this unit via FTP or the BROWSE screen.
Rebuild current Project?	Confirm that you want to rebuild the current project.	
Rebuild current session and changed Directory?	Confirm that you want to rebuild the current session and changed directory.	This message appears when you touch a REBUILD button with a  mark after changing a file on this unit via FTP or the BROWSE screen.
Rebuild current Session?	Confirm that you want to rebuild the current session.	
Rebuild failed	Rebuilding failed.	
Rebuild selected project and changed Directory?	Confirm that you want to rebuild the selected project and changed directory.	This message appears when you touch a REBUILD button with a  mark after changing a file on this unit via FTP or the BROWSE screen.
Rebuild selected project?	Confirm that you want to rebuild the selected project.	
Rebuild selected session and changed Directory?	Confirm that you want to rebuild the selected session and changed directory.	This message appears when you touch a REBUILD button with a  mark after changing a file on this unit via FTP or the BROWSE screen.
Rebuild selected Session?	Confirm that you want to rebuild the selected session.	
Rebuilding All ...	Confirm that you want to rebuild all projects.	
Rebuilding project ...	The project is being rebuilt.	
Rebuilding Session ...	The session is being rebuilt.	
RECORD Error	An error occurred during recording.	
RECORD Error Buffer overflow	The recording buffer became full during recording, and writing to the media could not keep up.	
RECORD stopped. ABS time is over 24h.	The ABS time exceeded 24 hours in timeline mode, so recording stopped.	
RECORD stopped. Media Full.	The media ran out of space, so recording stopped.	
Redo Completed	Redoing an edit has completed.	
REMOTE/KEYBOARD Locked	The remote and keyboard connectors have been locked to prevent misoperation.	
Renaming Project "pppppp" to "nnnnnn"	The project name is being changed.	pppppp = old project name nnnnnn = new project name
--- RETAKE --- Ignore last RECORD pass?	A retake will be performed. The previous take will be discarded.	
Save changes in Current EDL "sssssss"	Confirm that you want to save changes to the current timeline.	sssssss = AES31 editing data file name EDL = edit decision list
Save changes in Current Playlist "IIIIIII"	Confirm that you want to save changes to the current playlist.	IIIIIII = playlist name
Save current setting to User Preset?	Confirm that you want to save the current settings as the user preset.	
Save Failed.	Saving the file failed.	
Saving File. Do not remove MM	The file is being saved. Do not remove the CF card.	MM = CF1 or CF2
Screen Locked LCD Section Locked	LCD section controls have been locked to prevent misoperation.	
Screen Locked Touch Panel Locked Out	The touch screen has been locked to prevent misoperation.	
Select Insert Position [File T/C][Current Position]	Select the file T/C position or current position as the position where the file will be inserted.	
Select Paste Position [File T/C][Current Position]	Select the file T/C position or current position as the position where the file will be pasted.	
Session Delete failed.	Deleting the session failed.	
Session Export failed	Exporting the session failed.	
Session Load failed.	Loading the session failed.	
Sort all takes?	Confirm that you want to sort all the takes.	

Message	Details and responses	Notes
Take Copy failed.	Failed to copy the take.	
Take Delete failed.	Failed to delete the take.	
Take Export failed.	Failed to export the take.	
Take Load failed.	Failed to load the take.	
There is no Entry.	The playlist does not have any entries, so playback is not possible. Select a playlist with entries or add entries to the current one.	
There is no project. Please create a project.	There is no project so the recording cannot be made. Make a project.	
There is no Session. Please make a Session.	There is no session so the recording cannot be made. Make a session.	
There is no Take.	There are no takes, so playback is not possible. Select a session with takes.	
This file was converted to BWF format.	The file format was converted to BWF.	This appears after the Start timecode of a WAV file is edited.
This name already exists.	Another project, session or take already has that name.	
This name already exists. Overwrite this file? "nnnnnnnn"	A file with same name already exists. Confirm that you want to overwrite it.	nnnnnnnn = file name
Transport Locked Transport Section Locked	The transport keys have been locked to prevent misoperation.	
Undo Completed	Undoing an edit has completed.	
Unsupported File (too many tracks)	The file that you tried to play or add to a playlist has an unsupported number of tracks.	
Unsupported Fs	The sampling frequency of the file that you tried to add to a playlist is not supported.	
Writing System File...	Recording has stopped, but recording information is still being written.	

18 – Specifications

General

Recording media

Compact Flash cards

File system

FAT32 (4 GB or more)

FAT16 (2GB or less)

File formats

BWF (Broadcast Wave)

WAV (Waveform Audio)

Number of channels

2 channels

Quantization bit rates

16-bit, 24-bit

Sampling frequencies

44.1/47.952/48/48.048/88.2/96/176.4/192 kHz

(47.952/48.048: 48 kHz $\pm 0.1\%$ pull-down/pull-up)

Clock references

INTERNAL, WORD IN, VIDEO IN, DIGITAL IN

Timecode frames

23.976, 24, 25, 29.97DF, 29.97NDF, 30DF, 30NDF

Inputs and outputs

Analog audio inputs and outputs

The error for nominal and maximum levels is ± 1 dB for all input and output jacks except the **PHONES** jack.

ANALOG IN (LINE) connectors (L/R)

Connectors: XLR-3-31 (1: GND, 2: HOT, 3: COLD)

Input impedance: 4.3 k Ω

Nominal input level:

+4 dBu (1.23 Vrms) ± 1 dB/-20 dBu (0.0775 Vrms) ± 1 dB

(+4 dBu/-20 dBu selectable)

(+6 dBu only when set to Max +15 dBu)

(+6 dBu only when Digital Ref. Level is set to -9 dB)

Maximum input level (selectable):

+15 dBu (4.36 Vrms) (D. Ref: -9 dBFS, A. Input: +6 dBu)

+18 dBu (6.16 Vrms) (D. Ref: -14 dBFS, A. Input: +4 dBu)

+20 dBu (7.75 Vrms) (D. Ref: -16 dBFS, A. Input: +4 dBu)

+22 dBu (9.76 Vrms) (D. Ref: -18 dBFS, A. Input: +4 dBu)

+24 dBu (12.3 Vrms) (D. Ref: -20 dBFS, A. Input: +4 dBu)

-6 dBu (0.388 Vrms) (D. Ref: -14 dBFS, A. Input: -20 dBu)

-4 dBu (0.489 Vrms) (D. Ref: -16 dBFS, A. Input: -20 dBu)

-2 dBu (0.616 Vrms) (D. Ref: -18 dBFS, A. Input: -20 dBu)

0 dBu (0.775 Vrms) (D. Ref: -20 dBFS, A. Input: -20 dBu)

D. Ref: Digital Ref. Level setting

A. Input: Analog Input Ref. Lvl setting

ANALOG OUT (LINE) connectors (L/R)

Connector: XLR-3-32 (1: GND, 2: HOT, 3: COLD)

Output impedance: 100 Ω or less

Nominal output level:

+4 dBu (1.23 Vrms) ± 1 dB/-20 dBu (0.0775 Vrms) ± 1 dB

(+4 dBu/-20 dBu selectable)

(+6 dBu only when Digital Ref. Level is set to -9 dB)

Maximum output level (selectable):

+15 dBu (4.36 Vrms) (D. Ref: -9 dBFS, A. Output: +6 dBu)

+18 dBu (6.16 Vrms) (D. Ref: -14 dBFS, A. Output: +4 dBu)

+20 dBu (7.75 Vrms) (D. Ref: -16 dBFS, A. Output: +4 dBu)

+22 dBu (9.76 Vrms) (D. Ref: -18 dBFS, A. Output: +4 dBu)

+24 dBu (12.3 Vrms) (D. Ref: -20 dBFS, A. Output: +4 dBu)

-6 dBu (0.388 Vrms) (D. Ref: -14 dBFS, A. Output: -20 dBu)

-4 dBu (0.489 Vrms) (D. Ref: -16 dBFS, A. Output: -20 dBu)

-2 dBu (0.616 Vrms) (D. Ref: -18 dBFS, A. Output: -20 dBu)

0 dBu (0.775 Vrms) (D. Ref: -20 dBFS, A. Output: -20 dBu)

D. Ref: Digital Ref. Level setting

A. Output: Analog Output Ref. Level setting

ANALOG OUT (MONITOR) connectors (L/R)

Connector: XLR-3-32 (1: GND, 2: HOT, 3: COLD)

Output impedance: 100 Ω or less

Nominal output level:

When reference level set to -9 dB: +6 dBu (1.55 Vrms)

When reference level set to any value other than -9 dB: +4

dBu (1.23 Vrms)

Maximum output level (selectable):

+15 dBu (4.36 Vrms) (D. Ref: -9 dBFS, A. Output: +6 dBu)

+18 dBu (6.16 Vrms) (D. Ref: -14 dBFS, A. Output: +4 dBu)

+20 dBu (7.75 Vrms) (D. Ref: -16 dBFS, A. Output: +4 dBu)

+22 dBu (9.76 Vrms) (D. Ref: -18 dBFS, A. Output: +4 dBu)

+24 dBu (12.3 Vrms) (D. Ref: -20 dBFS, A. Output: +4 dBu)

D. Ref: Digital Ref. Level setting

A. Output: Analog Output Ref. Level setting

PHONES jack

Connector: standard 6.3mm (1/4") stereo jack

Maximum output level: 45 mW + 45 mW or more

(THD+N 0.1% or less, into 32 Ω)

Digital audio inputs and outputs

DIGITAL IN [LINE] connector

Connector: XLR-3-31
Input signal voltage amplitude: 200 mVp-p to 10 Vp-p
Input impedance: 110 Ω \pm 20%
Format: AES3-2003/IEC60958-4 (AES/EBU)
IEC60958-3 (S/PDIF)
Supported sampling frequencies:
44.1/47.952/48/48.048/88.2/96/176.4/192kHz
(single/double/quad)
(47.952/48.048: 48 kHz \pm 0.1% pull-down/pull-up)
Note: When SRC is ON, the receivable range is 32–192 kHz.

DIGITAL OUT [LINE] connector

Connector: XLR-3-32
Output voltage: 2–5 Vp-p
Output impedance: 110 Ω \pm 20%
Format: IEC60958-4 (AES3-2003, AES/EBU)
Supported sampling frequencies:
44.1/47.952/48/48.048/88.2/96/176.4/192kHz
(single/double/quad)
(47.952/48.048: 48 kHz \pm 0.1% pull-down/pull-up)

Control inputs and outputs

RS-422 connector

Connector: D-sub 9-pin (female, inch-standard)

RS-232C connector

Connector: D-sub 9-pin (female, inch-standard)

PARALLEL connector

Connector: D-sub 25-pin (female, inch-standard)

Timecode INPUT connector

Connector: XLR-3-31
Signal voltage amplitude: 0.5–10 Vp-p
Input impedance: 10 k Ω
Format: SMPTE 12M-1999 compliant

Timecode OUTPUT connector

Connector: XLR-3-32
Signal voltage amplitude: 2 Vp-p
Output impedance: 100 Ω
Format: SMPTE 12M-1999 compliant

WORD/VIDEO IN connector

Connector: BNC
Input voltage: 5V TTL equivalent (WORD IN)
Signal voltage amplitude: 1 Vp-p (VIDEO IN)
Input impedance: 75 Ω \pm 10%
Allowable frequency deviation of external synchronization: \pm 100 ppm
Includes switch for enabling termination
Input frequency (WORD):
44.1/47.952/48/48.048/88.2/96/176.4/192kHz
(47.952/48.048: 48 kHz \pm 0.1% pull-down/pull-up)
Input signal (VIDEO):
24/25/29.97/30 Frame
(NTSC/PAL Black burst, HDTV Tri-Level)

WORD/VIDEO THRU/OUT connector

Connector: BNC
Signal voltage amplitude: 5V TTL equivalent
Output impedance 75 Ω \pm 10%
Output frequency (WORD):
44.1/47.952/48/48.048/88.2/96/176.4/192kHz
(47.952/48.048: 48kHz \pm 0.1% pull-down/pull-up)
Frequency stability: \pm 10 ppm or less (Ta = 20° C)
OUT/THRU switch included
(OUT is only for WORD OUT)

ETHERNET connector

Connector: RJ45
Supported standards: 100BASE-TX, 1000BASE-T

KEYBOARD connector

Connector: Mini-DIN (PS/2)

USB connector

Connector: USB A-type 4-pin
Protocol: USB 2.0 HIGH SPEED (480 Mbps)

REMOTE connector

Connector: etherCON (CAT6 compatible)
Power supply voltage: 13 V/41 V
Signal: LVDS serial

18 – Specifications

Audio performance

Frequency response

- ANALOG IN to ANALOG OUT:
 - 20 Hz – 20 kHz: ± 0.5 dB ($F_s = 44.1/48$ kHz, JEITA)
(recording and playback)
 - 20 Hz – 40 kHz: $+0.5$ dB/ -2 dB ($F_s = 88.2/96$ kHz, JEITA)
(recording and playback)
 - 20 Hz – 80 kHz: $+0.5/-5$ dB ($F_s = 176.4/192$ kHz, JEITA)
(recording and playback)

Distortion

- ANALOG IN to ANALOG OUT: 0.005% or less
(JEITA) (recording and playback)

S/N ratio

- ANALOG IN to ANALOG OUT: 100 dB or more
(JEITA) (recording and playback)

Other specifications

Power

- AC 100-240 V, 50-60 Hz

Power consumption

- 25 W

External dimensions (W x H x D)

- 482.6 x 94 x 317.1 mm (not including protrusions)

Weight

- 5.1 kg

Operating temperature range

- 5–35° C

Dimensional drawings

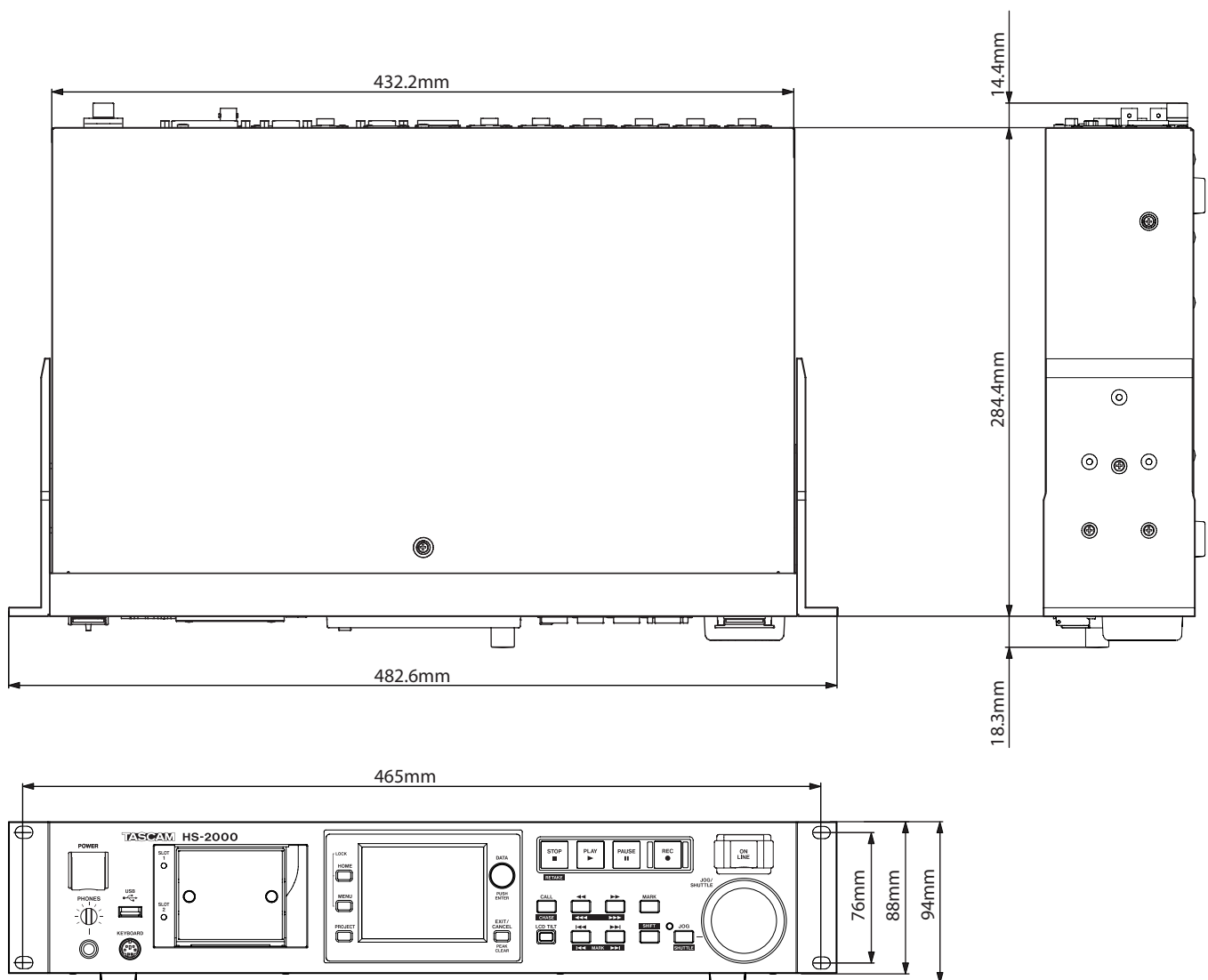

Block diagram

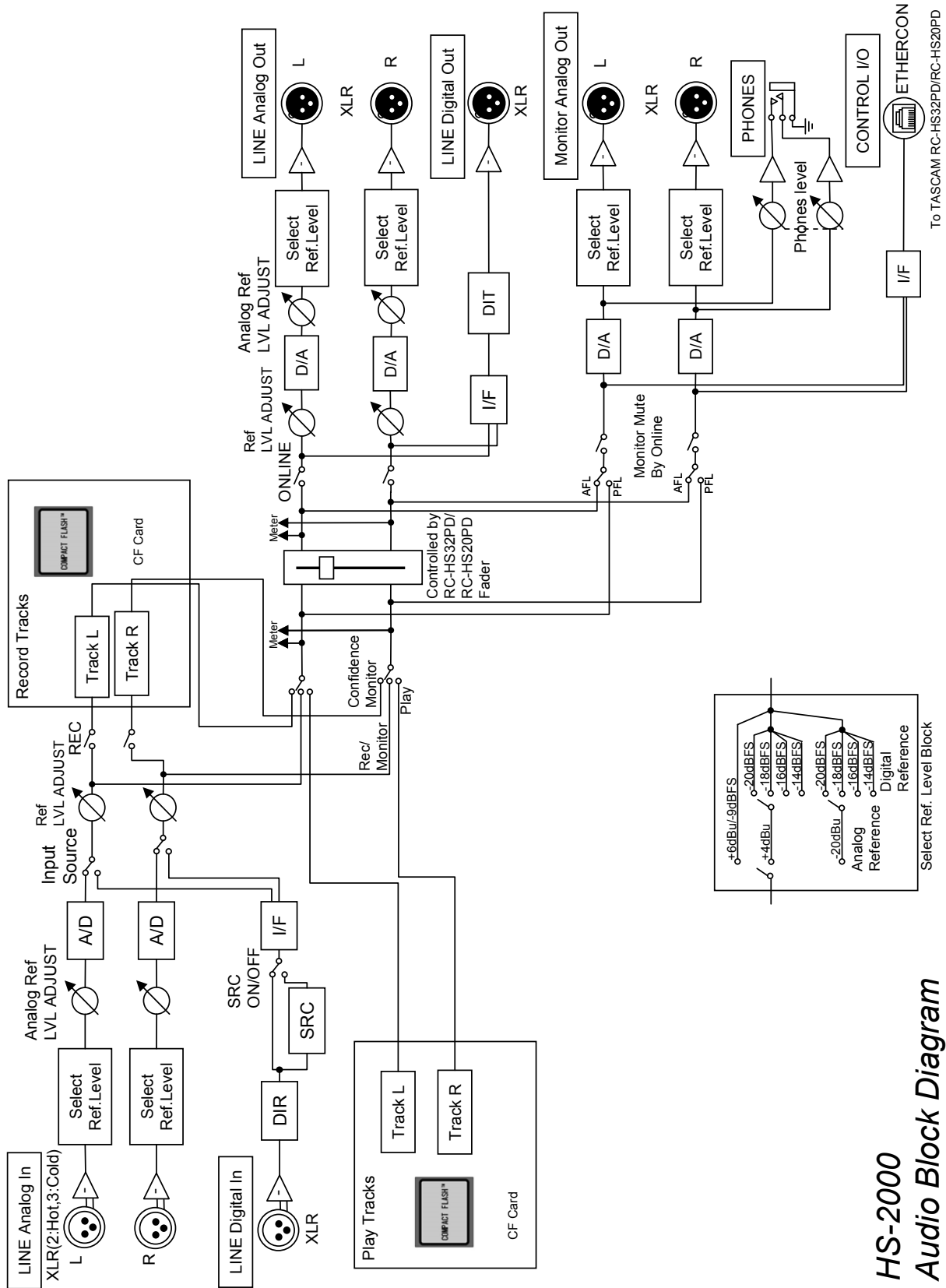

HS-2000
Audio Block Diagram

TASCAM

HS-2000

TEAC CORPORATION

Phone: +81-42-356-9143

1-47 Ochiai, Tama-shi, Tokyo 206-8530, Japan

<http://tascam.jp/>**TEAC AMERICA, INC.**

Phone: +1-323-726-0303

7733 Telegraph Road, Montebello, California 90640 USA

<http://tascam.com/>**TEAC CANADA LTD.**

Phone: +1905-890-8008 Facsimile: +1905-890-9888

5939 Wallace Street, Mississauga, Ontario L4Z 1Z8, Canada

<http://tascam.com/>**TEAC MEXICO, S.A. de C.V.**

Phone: +52-55-5010-6000

Río Churubusco 364, Colonia Del Carmen, Delegación Coyoacán, CP 04100, México DF, México

<http://www.teacmexico.net/>**TEAC UK LIMITED**

Phone: +44-8451-302511

Suites 19 & 20, Building 6, Croxley Green Business Park, Hatters Lane, Watford, Hertfordshire, WD18 8TE, UK

<http://www.tascam.co.uk>**TEAC EUROPE GmbH**

Phone: +49-611-71580

Bahnstrasse 12, 65205 Wiesbaden-Erbenheim, Germany

<http://www.tascam.de/>