

TASCAM

D01268420C

Celesonic

US-20x20

USB Audio MIDI Interface with Mic Pre/Mixer

REFERENCE MANUAL

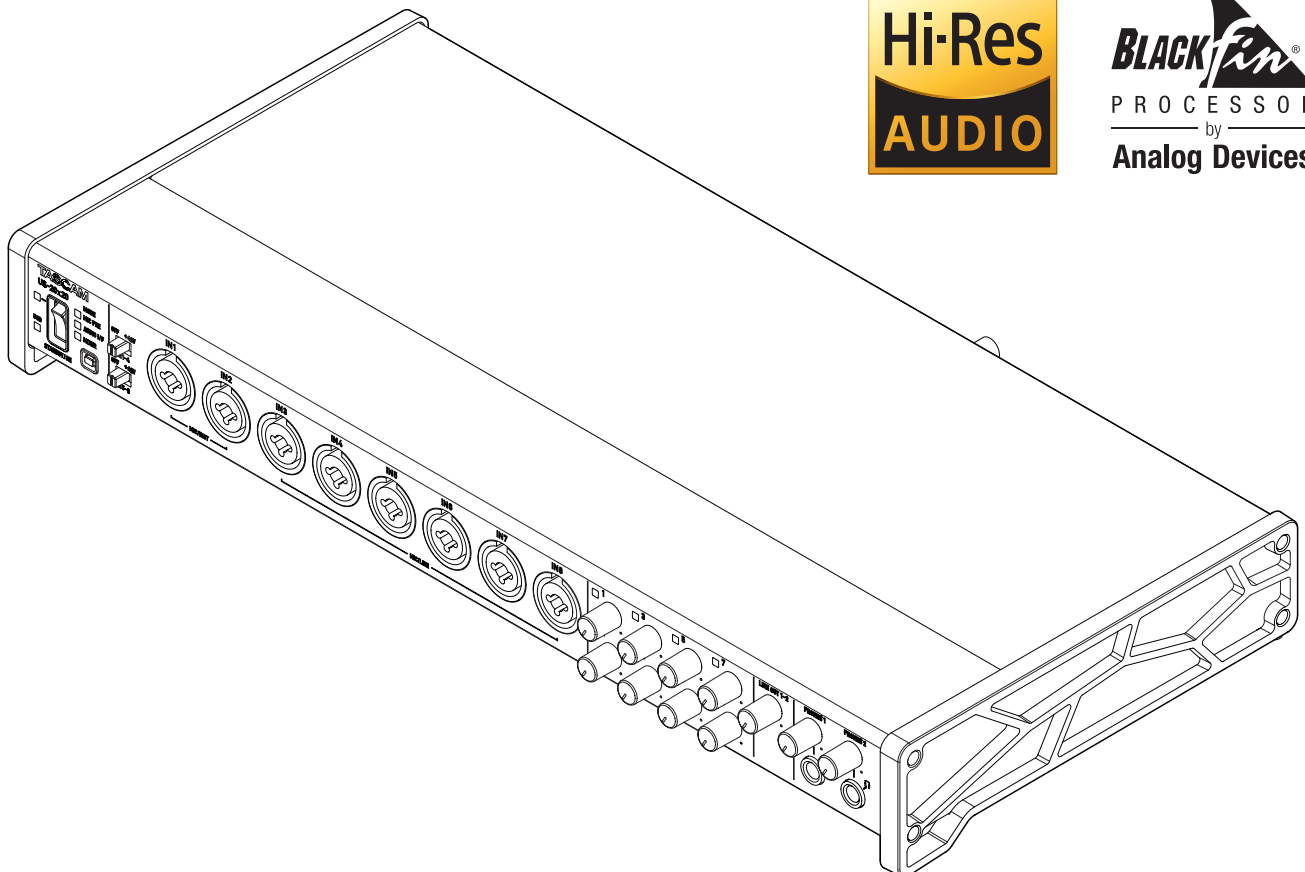

Before connecting this unit to a computer, you must download and install dedicated software on the computer.

Contents

1 – Introduction	3
Features	3
Conventions used in this manual	3
Trademarks and copyrights.....	3
2 – Names and functions of parts	4
Front panel	4
Rear panel	5
3 – Installation	6
System requirements.....	6
Windows.....	6
Mac.....	6
iOS devices	6
Supported audio drivers	6
Installing the dedicated software	6
Installing the Windows driver	7
Installing the Mac Settings Panel	8
Working with Gatekeeper	8
Uninstalling the dedicated software	9
4 – Preparation.....	10
Attaching the rack mount angles	10
Connecting the power	10
Changing the outlet plug.....	10
5 – Connections.....	11
Examples of connections with other equipment..	11
Computer connections.....	12
Audio connections	12
Microphones.....	12
Guitar	13
Electronic devices and other audio equipment ..	13
Analog record players	13
Monitor speakers.....	13
Headphones.....	13
MIDI connections.....	13
Connecting with iOS devices.....	13
6 – Using the Settings Panel	14
Opening the Settings Panel	14
Windows OS.....	14
Mac OS X.....	14
Settings Panel overview	14
MIXER page	15
EQUALIZER (4-band parametric EQ) display area overview	18
COMPRESSOR display area overview	19
REVERB display area overview.....	19
LINK button overview.....	20
INTERFACE page	21
Status display area	21
Setting area	21
OUTPUT SETTING page.....	22
Using the Settings Panel View menu.....	23
Initializing the Settings Panel	23
Resetting the reverb settings	24
Using the SceneMemory menu	25
Saving Settings Panel settings	25
Loading Settings Panel settings	26
Changing scene memory names.....	26
Resetting all scene memories.....	27
Saving Settings Panel settings to the unit	27
7 – Operation modes	28
Using the unit as a microphone preamp.....	28
Changing the sampling frequency in mic preamp mode.....	28
Input and output channels in mic preamp mode..	29
Using the unit in audio interface mode.....	29
Changing the sampling frequency in audio interface mode.....	29
Using the unit in digital mixer mode	29
The sampling frequency can be changed in digital mixer mode.	29
8 – Application Guide	30
DAW software.....	30
Windows Media Player.....	30
Windows 10.....	30
Windows 8.1	30
Windows 7	31
Mac OS X and iTunes.....	31
iOS	31
9 – MIDI Implementation Chart	32
10 – Troubleshooting	33
11 – Specifications	36
Ratings	36
Input/output ratings	36
Analog inputs	36
Analog outputs	36
Digital audio input/output ratings	36
Control input/output ratings	37
Audio performance	37
Computer system requirements	37
Windows.....	37
Mac OS X.....	38
iOS devices	38
Supported audio drivers	38
General	38
Dimensional drawings	39
Block diagrams.....	40
Mic preamp mode	40
Audio interface mode.....	41
Digital mixer mode.....	42
Level diagrams	43

Features

- Ultra-HDDA (High Definition Discrete Architecture) mic preamps with –125dBu EIN
- 8 Ultra-HDDA mic preamps, 8 XLR/TRS inputs and 2 TRS input jacks
- Three switchable modes: interface, mic preamp, mixer
- Support for high-resolution recording formats up to 24-bit/192kHz
- Supports Windows and Mac
 - Windows: Windows 10 only
 - Mac: OS X El Capitan (10.11.2 or newer) only
- Connect with iOS devices including iPad
- Can provide +48V phantom power
- Supports direct guitar input.
- Input level specifications boast a 56dB range and support dynamic mic input
- Tough metal casing can endure even hard use
- Angled design provides excellent usability on a desktop
- Two 70mW+70mW standard TRS headphone output jacks
- Separate controls for line and headphone output volumes
- MIDI input and output enable connection with keyboards and other MIDI devices
- Low latency monitoring through the DSP mixer
- DSP mixer with 4-band EQ and compression on each input channel (usable in interface and mixer modes)
- Patch bay allows outputs to be assigned freely (usable in interface and mixer modes)
- Ten scene memories (can be renamed) for saving DSP mixer settings
- Ten analog TRS output jacks
- S/PDIF COAXIAL digital input and output jacks
- TOSLINK multichannel optical digital input and output connectors (support SMUX2/SMUX4)
- BNC word clock input and output connectors
- Supports USB Audio Class 2.0
- Operation confirmed with major DAW software, including Sonar, ProTools, Cubase, Live, Studio One and GarageBand
- Product compliant with RoHS
- Rack mount adapters and hex key included
- AC adapter included

■ Note about computer operation

If you are unsure about anything related to the basic operation of a computer when it is mentioned in an explanation in this manual, please refer to the computer operation manual.

Conventions used in this manual

In this manual, we use the following conventions:

- Switches, connectors and other physical parts of this unit are written using a bold font like this: **PHONES** knob.
- Information shown on a computer display is written like this: "OK".
- As necessary, additional information is provided under TIP, NOTE and CAUTION headings.

TIP

These are tips about how to use the unit.

NOTE

These provide additional explanations and describe special cases.

CAUTION

Failure to follow these instructions could result in injury, damage to equipment or lost recording data, for example.

Trademarks and copyrights

- TASCAM is a trademark of TEAC CORPORATION, registered in the U.S. and other countries.
- Microsoft, Windows and Windows Vista are either registered trademarks or trademarks of Microsoft Corporation in the United States and/or other countries.
- Apple, Mac, Mac OS X, and Lightning are trademarks of Apple Inc.
- IOS is a trademark or registered trademark of Cisco in the U.S. and other countries and is used under license.
- ASIO is a trademark and software of Steinberg Media Technologies GmbH.



- Blackfin® and the Blackfin logo are registered trademarks of Analog Devices, Inc.
- Other company names, product names and logos in this document are the trademarks or registered trademarks of their respective owners.

2 – Names and functions of parts

Front panel

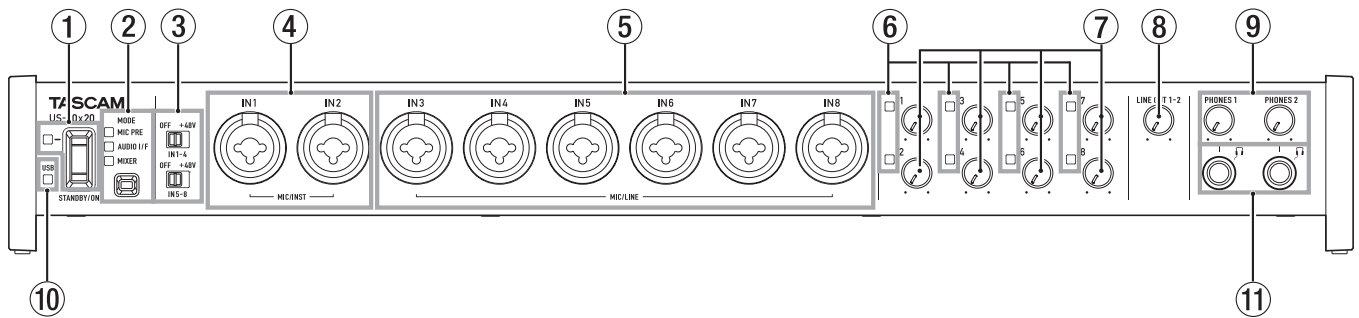

① STANDBY/ON switch and indicator

Press to turn the unit on and to put it into standby. The **STANDBY/ON** indicator lights green when the unit is on.

② MODE button and indicators

Use to change the operation mode. (See “7 – Operation modes” on page 28.)

MIC PRE

This lights when the unit is operating as a microphone preamp.

AUDIO I/F

This lights when the unit is operating as an audio interface.

MIXER

This lights when the unit is operating as a digital mixer.

NOTE

If the signal stops being input from the sample clock source set by the Sample Clock Source item on the “INTERFACE” page or synchronization with it becomes impossible, this unit’s sample clock will become unlocked and the indicator for the set operation mode will blink. (See “Setting area” on page 21.)

③ Phantom power switches

Use these switches to provide **+48V** phantom power to the **IN1–IN4** and **IN5–IN8** jacks.

You can change the Phantom power setting for four channels of inputs at a time. Phantom power is supplied when the switch is set to **+48V**.

CAUTION

- Do not connect or disconnect mics when the phantom power switch is set to **+48V**. Doing so could cause a loud noise and might damage this unit and connected equipment.
- Set the phantom power switch to **+48V** only when using a condenser microphone that requires phantom power. Setting phantom power to **+48V** when a dynamic mic or other mic that does not require it is connected could damage this unit and connected equipment.
- When using condenser mics that require phantom power and dynamic mics together, be sure to use balanced dynamic mics. Unbalanced dynamic mics cannot be used when phantom power is enabled.
- Supplying phantom power to some ribbon mics will break them. If you are unsure, do not supply phantom power to a ribbon mic.
- Set the **LINE OUT 1–2** and **PHONES 1/2** knobs to their minimum values before changing a phantom power switch setting. Failure to do so could cause sudden loud

noises from monitoring equipment, and this could damage equipment or harm hearing.

④ MIC/INST IN1–IN2 jacks (balanced/unbalanced)

These analog inputs are XLR/TRS combo jacks.

They support high impedance input, including direct guitar input.

- XLR (1: GND, 2: HOT, 3: COLD)
 - TRS (Tip: HOT, Ring: COLD, Sleeve: GND)
- Use the gain knobs to set input gains.

⑤ MIC/LINE IN3–IN8 jacks (balanced)

These analog inputs are XLR/TRS combo jacks.

These jacks support line input from audio equipment and keyboards, for example.

- XLR (1: GND, 2: HOT, 3: COLD)
 - TRS (Tip: HOT, Ring: COLD, Sleeve: GND)
- Use the gain knobs to set input gains.

⑥ Signal/overload indicators

These light red when signals are about to distort (–1 dBFS) and the light green when signals are being input (–32 dBFS or higher).

⑦ Gain knobs

Use these knobs to adjust the gains of **IN1–IN8** independently.

The gains of **IN1–IN8** can each be set in a range between –12 dBu and –68 dBu.

⑧ LINE OUT 1–2 knob

Use to adjust the output level of the **LINE OUT 1–2** jacks on the back of the unit.

⑨ PHONES 1/2 knobs

Use to adjust the output levels of the **PHONES 1/2** jacks.

CAUTION

*Before connecting headphones to a jack, minimize its **PHONES** knob. Failure to do so might cause sudden loud noises, which could harm your hearing or result in other trouble.*

⑩ USB indicator

This lights orange when the USB connection is enabled.

⑪ PHONES 1/2 jacks

Use these standard stereo jacks to connect stereo headphones. The same signal is output from the **LINE OUT 1/2** jacks.

Use an adapter to connect headphones with a mini plug.

2 – Names and Functions of Parts

Rear panel

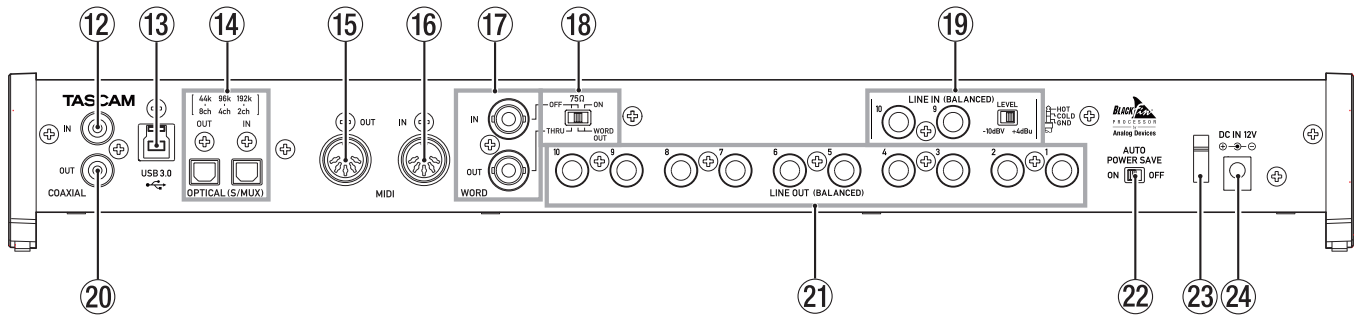

12 COAXIAL IN jack

This digital audio input jack complies with the S/PDIF standard.

13 USB port

Use the included USB cable to connect the unit to a computer or iOS device (supports USB 2.0/3.0).

CAUTION

- The included USB cable (USB 2.0 or USB 3.0) that can be used depends on the computer and OS you are using. (See "Computer connections" on page 12.)
- USB 1.1 is not supported.

14 OPTICAL (S/MUX) IN/OUT connectors

These input and output multichannel digital audio in optical format.

44.1, 48, 88.2, 96, 176.4 and 192kHz sampling frequencies are supported.

SMUX2 is supported for 88.2/96kHz formats, and SMUX4 is supported for 176.4/192kHz formats.

15 MIDI OUT connector

This 5-pin DIN is a standard MIDI output jack.

This outputs MIDI signals.

16 MIDI IN connector

This 5-pin DIN is a standard MIDI input jack.

Use this to input MIDI signals.

17 WORD IN/OUT connectors

These BNC connectors are for the input and output of word clock signals.

Word clock signals of 44.1, 48, 88.2, 96, 176.4 and 192 kHz can be input and output.

CAUTION

If a digital system has multiple word clock masters, serious problems, including damage to equipment, could occur.

18 75Ω ON/OFF/THRU/WORD OUT switch

Use this switch to make the following settings.

- Whether or not the **WORD IN** connector has 75Ω termination
- WORD output THRU/OUT setting (OUT is for WORD only)

19 LINE IN 9-10 (BALANCED) jacks and LEVEL switch

These standard TRS jacks are line inputs. (Tip: HOT, Ring: COLD, Sleeve: GND)

Use the **LEVEL** switch to set the nominal level to -10dBV or $+4\text{dBu}$.

NOTE

The input gain cannot be adjusted for these jacks.

20 COAXIAL OUT jack

This digital audio output jack complies with S/PDIF and AES/EBU standards.

Set the digital signal format on the "INTERFACE" page of the Settings Panel.

21 LINE OUT (BALANCED) 1-10 jacks

These standard TRS jacks are analog line outputs. The nominal output level is $+4\text{dBu}$.

(Tip: HOT, Ring: COLD, Sleeve: GND)

22 AUTO POWER SAVE switch

Use this switch to have the unit turn itself off automatically (start standby) when operating in mic preamp mode if no input signal above -60dBFS is detected for 30 minutes.

CAUTION

*If you want to turn the unit on again after it has turned itself off (started standby) automatically, press the **STANDBY/ON** button once, wait at least 8 seconds and then press the **STANDBY/ON** button again.*

23 Cord holder

Hook the cord of the included AC adapter here to prevent accidental disconnection.

24 DC IN 12V connector

Connect the included AC adapter (GPE248-120200-Z) here.

3 – Installation

System requirements

Check the TEAC Global Site (<http://teac-global.com/>) for the latest information about supported operating systems.

Windows

■ Supported operating systems

Windows 10 32-bit
Windows 10 64-bit
Windows 8.1 32-bit
Windows 8.1 64-bit
Windows 7 32-bit SP1 or later
Windows 7 64-bit SP1 or later

■ Computer hardware requirements

Windows computer with a USB 2.0 or USB 3.0 port

■ CPU/processor speed

2 GHz or faster dual core processor (x86)

■ Memory

2 GB or more

■ Display resolution

1280×800 or greater

CAUTION

- *The included USB cable (USB 2.0 or USB 3.0) and the USB specification that can be used depend on the computer and OS you are using. (See “Computer connections” on page 12.)*
- *Operation of this unit was confirmed using standard computers that meet the above requirements. This does not guarantee operation with all computers that meet the above requirements. Even computers that meet the same system requirements might have processing capabilities that differ according to their settings and other operating conditions*

NOTE

Since noise could occur depending on the computer system used, we recommend selecting “High performance” in the Power Options Control Panel.

Mac

■ Supported operating systems

OS X El Capitan (10.11.2 or later)
OS X Yosemite (10.10.1 or later)
OS X Mavericks (10.9.5)
OS X Mountain Lion (10.8.5)

■ Computer hardware requirements

Mac with a USB 3.0 or USB 2.0 port

■ CPU/processor speed

2 GHz or faster dual core processor

■ Memory

2 GB or more

■ Display resolution

1280×800 or greater

CAUTION

The included USB cable (USB 2.0 or USB 3.0) and the USB specification that can be used depends on the computer and OS you are using. (See “Computer connections” on page 12.)

iOS devices

Device made by Apple Inc. running iOS 7 or later

Supported audio drivers

■ Windows

USB Audio Class 2.0, ASIO 2.0, WDM (MME), MIDI

■ Mac

Core Audio, Core MIDI

Installing the dedicated software

To use this unit with a computer, dedicated software must be installed on the computer.

Download the latest software for the operating system you are using from the TEAC Global Site (<http://teac-global.com/>).

- To use this unit with a Windows computer, install the Windows driver.
When you install the Windows driver, the Windows Settings Panel application will be installed at the same time.
- To use this unit with a Mac, install the Mac Settings Panel application.
The standard OS driver will be used.
- When using this unit with an iOS device, the standard OS driver will be used, so there is no need to install dedicated software.

CAUTION

Before starting to install software, quit other applications.

Installing the Windows driver

CAUTION

- Complete installation of the Windows driver on the computer before connecting the unit to it with the USB cable.
- If you already connected the unit to the computer using the USB cable before installing the Windows driver and the Found New Hardware Wizard launched, close the message and disconnect the USB cable.

Windows driver installation procedures

1. Download the latest Windows driver for the operating system you are using from the TEAC Global Site (<http://teac-global.com/>) and save it on the computer to be used with the unit.
2. Open the saved Windows driver (zip file) on, for example, the computer desktop.
3. Double-click the “US-20x20_Installer” file in the folder that appears after uncompression to automatically launch the installation software.

CAUTION

If you open a zip file without uncompressing it and double-click the “US-20x20_Installer.exe” file in the folder that opens, installation will not start. Right-click the zip file and select “Extract All”, for example, to uncompress it and then try again.

4. When a “Security Warning” or “User Account Control” screens appear, click the “Yes” button.
5. When the InstallShield Wizard screen appears, click the “Next (N)” button.

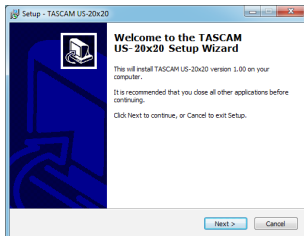

6. Read the contents of the License Agreement, and select “Agree (A)” if you agree to the terms. Then, click the “Next (N)” button.

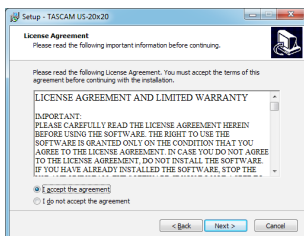

7. Click the “Install (I)” button.

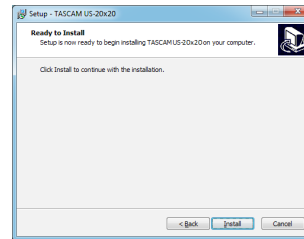

8. Next, click the “Install (I)” button to start installation.

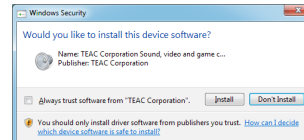

9. The following screen appears when installation has completed. Click the “Finish (F)” button.

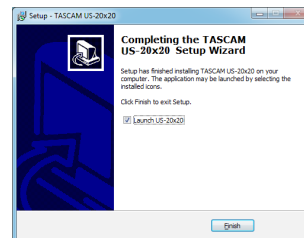

The installer will quit and the Windows Settings Panel will launch.

NOTE

After installing the driver, the device driver will be installed the first time the unit is connected by USB. At this time, Windows will automatically search Windows Update, and it may take some time to recognize the unit connection. If the unit is still not recognized after some time, open the software installation screen from the message area at the bottom right of the computer display, and click “Skip Obtaining Drivers From Windows Update” to cancel the search.

3 – Installation

Installing the Mac Settings Panel

NOTE

- Install the Mac Settings Panel on the computer before connecting the unit to it with the USB cable.
- During installation of the Mac Settings Panel, a warning message such as "'US-20x20.pkg' can't be opened because it was not downloaded from the Mac App Store." might appear. If a message like this appears, follow the instructions in "Working with Gatekeeper" on page 8 and then proceed with the installation.

■ Mac Settings Panel installation procedures

1. Download the latest Mac Settings Panel for the operating system you are using from the TEAC Global Site (<http://teac-global.com/>) and save it on the computer to be used with the unit.
2. Double-click "US-20x20_Installer.dmg", which is the saved disk image file for the Mac Settings Panel, and double-click "US-20x20.pkg" inside the folder that opens.



US-20x20 .pkg

NOTE

Depending on the computer's settings, the downloaded zip file might not have opened automatically. In this case, open the zip file first and then double-click the disk image file.

3. When the installer starts, click the "Continue" button.

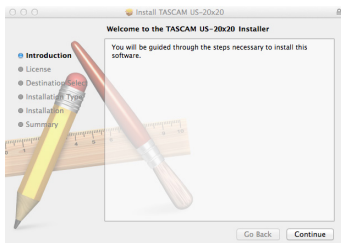

4. Next, select the desired language and click the "Continue" button.

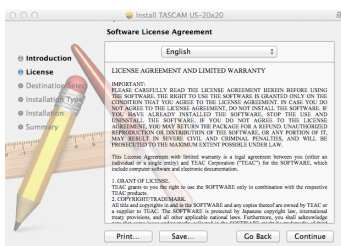

5. Click the "Read License" button and check the contents of the Software License Agreement. If you agree to the contents, click "Agree". Then, click the "Next" button.

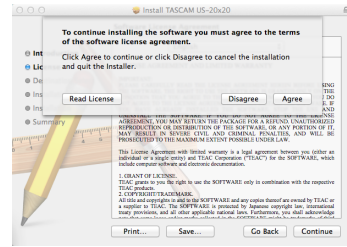

6. Next, click the "Install" button to start installation.

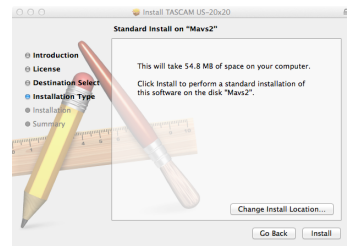

7. The following screen appears when installation has completed. Click the "Close" button.

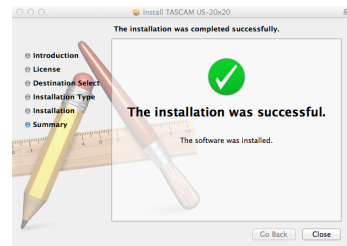

The Mac Settings Panel will launch.

Working with Gatekeeper

When using Mac OS X, depending on the Gatekeeper security function setting, a warning message might appear during installation.

The solution depends on the warning message shown. See the following explanations for details.

■ When the Gatekeeper setting is "Allow applications downloaded from: the Mac App Store"

The following security warning might be shown: "US-20x20.pkg' can't be opened because it was not downloaded from the Mac App Store."

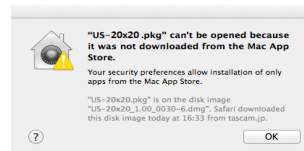

In this case, click the OK button to close the message. Then, control-click (or right-click) the file and click "Open".

When the “US-20x20.pkg” can't be opened because it was not downloaded from the Mac App Store. Are you sure you want to open it?” security warning message appears, click the “Open” button.

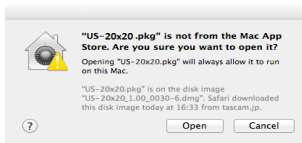

This warning message might also appear when the Gatekeeper setting is something other than “Allow applications downloaded from: the Mac App Store”.

The file still might not open and “US-20x20.pkg” can't be opened because it was not downloaded from the Mac App Store.” might appear again.

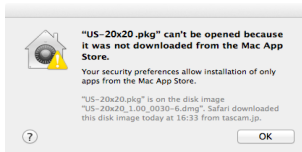

In this case, copy the file from the folder where it is to the desktop or another folder, and then open it. Alternatively, change the Gatekeeper setting to “Allow applications downloaded from: the Mac App Store and identified developers” and try opening it again.

■ Changing the Gatekeeper setting

The Gatekeeper setting can be changed using the “Allow applications downloaded from:” item on the “General” page of the “Security & Privacy” pane of the System Preferences.

To change this, you must click the lock icon (🔒) at the bottom left and enter a password to unlock the settings.

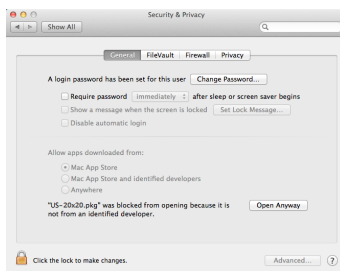

This setting will lock again when you quit the System Preferences by typing command-Q or clicking the (⏻) button, for example, or when you click the “Show All” button to close the open pane.

CAUTION

Changing the Gatekeeper setting could result in security risks.

If you changed the Gatekeeper setting to decrease security (use one of the lower settings), set it back to the original setting after updating the driver and/or firmware.

Uninstalling the dedicated software

NOTE

Normally, there is no need to uninstall a driver or Settings Panel. Follow these procedures if a problem occurs or you no longer intend to use the unit with the computer.

■ Windows

Uninstall from the “Programs and Features” Control Panel.

1. From the Start menu, open the Control Panel application, click Programs and then click Programs and Features.

NOTE

- *In Windows 10, right-click the Start button and click the Control Panel that appears.*
 - *In Windows 8.1, click the button (U) that appears at the bottom left of the Start screen to open the Apps screen, and click Control Panel.*
2. If “View by:” is set to “Category,” click “Uninstall a program” under the “Program” item.
If “View by:” is set to “Large icons” or “Small icons,” click “Programs and Features”.
 3. Double-click “TASCAM US-20x20 version X.XX” (“X.XX” is the driver software version) in the list.
 4. Then, follow the instructions that appear on the screen.

■ Mac

Delete “US-20x20” from the Application folder to complete uninstallation.

4 – Preparation

Attaching the rack mount angles

Before mounting this unit in a rack, you must remove the frame pieces and install the included rack mount angles. Follow these procedures to attach the rack mount angles. (Prepare a Phillips screwdriver in advance.)

1. Use the hex key included with this product to remove the four screws from each side frame as shown in the illustration below.

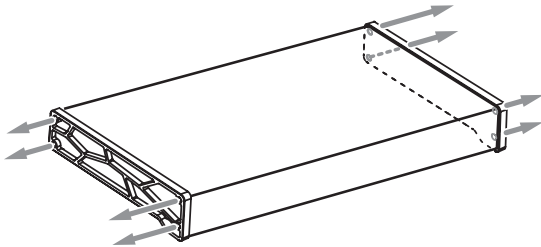

2. Remove the frames from both ends of the unit.
3. Use the Phillips screwdriver that you prepared to attach the included rack mount angles using the included rack mount angle installation screws.

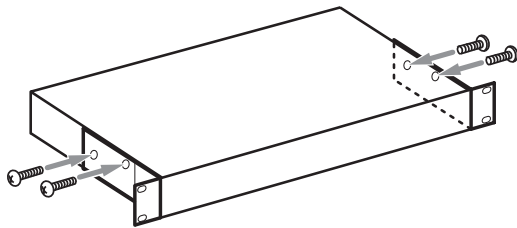

NOTE

Reverse these procedures to reinstall the frames that were originally attached to the unit.

Connecting the power

Use the included AC adapter (GPE248-120200-Z) to connect a power supply to the unit as shown below.

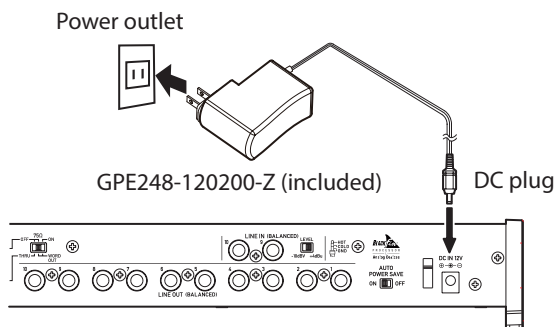

In order to prevent the cord from becoming disconnected during use, wrap it around the cord holder when connecting it.

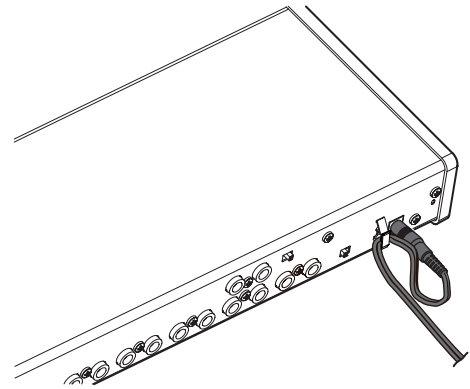

CAUTION

Always use the AC adapter (GPE248-120200-Z) that was shipped with the unit. Using a different AC adapter could cause malfunction, overheating, fire or other problems.

NOTE

The AC adapter for the unit includes two types of outlet plugs. Attach the type of plug that matches the power outlet that you are using. (See “Changing the outlet plug” on page 10.)

Changing the outlet plug

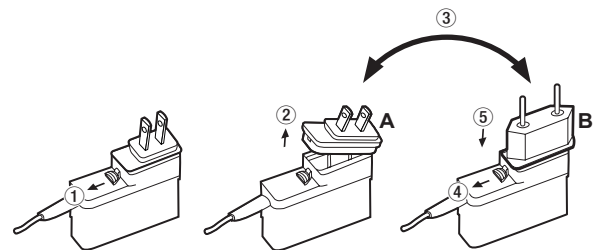

- ① Move the latch on the AC adapter in the direction of the arrow.
- ② Pull off the outlet plug.
- ③ Replace it with the other outlet plug (A or B).
- ④ Move the latch on the AC adapter in the direction of the arrow again.
- ⑤ Attach the outlet plug to the AC adapter.

After changing the outlet plug, confirm that it is not loose or crooked and that everything is normal before plugging it into an outlet

CAUTION

Do not use the adapter if there is anything abnormal about the plug after changing it. Use when the plug is abnormal could cause fire or electric shock. Contact the retailer where you purchased the unit or a TEAC service center (on the back cover) to request repair.

Examples of connections with other equipment

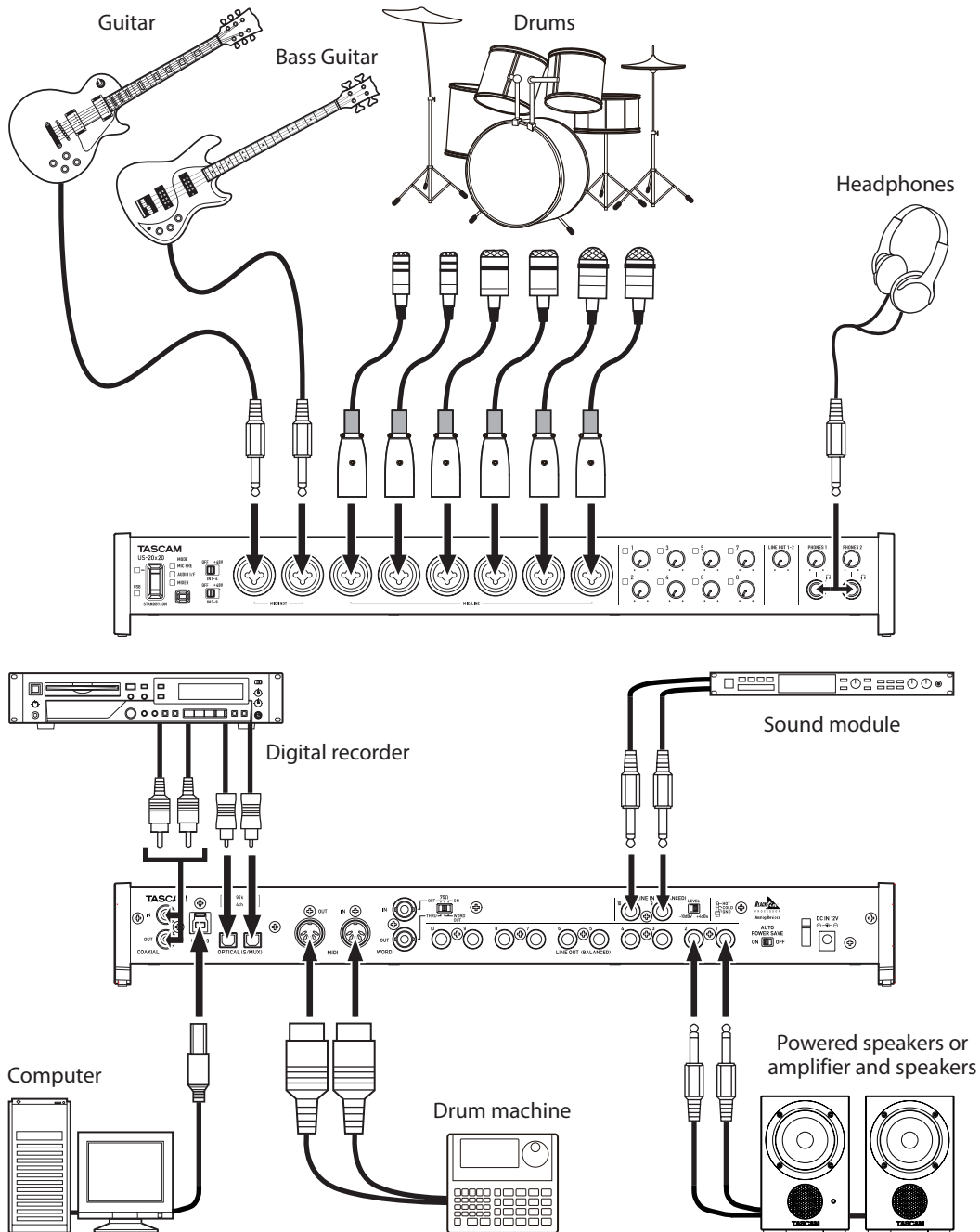

Example using a US-20x20

CAUTION

- Before making connections, turn this unit and all equipment to be connected off (standby).
- The phantom power switches set four input channels at a time. Do not set phantom power to +48V when connecting an unbalanced dynamic mic.
- Do not connect or disconnect mics while phantom power is set to +48V. Doing so could cause a loud noise and might damage this unit and connected equipment.
- Set the **LINE OUT 1-2** and **PHONES 1/2** knobs to their minimum values before changing a phantom power switch setting. Failure to do so could cause sudden loud noises from monitoring equipment, and this could damage equipment or harm hearing.
- Supplying phantom power to some ribbon mics will break them. If you are unsure, do not supply phantom power to a ribbon mic.

5 – Connections

Computer connections

Two types of USB cables (USB 2.0 or USB 3.0) are included.

Use an included USB cable to connect the unit to a computer USB 2.0 or USB 3.0 port according to the computer and OS that you are using.

When the USB connection is working, the USB indicator on the front of the unit lights.

Check the TEAC Global Site (<http://teac-global.com/>) for the latest information about supported operating systems.

■ Windows

Supported operating systems	USB standard		USB cable connected
	USB 2.0	USB 3.0	
Windows 10 32-bit	✓	✓*	USB 3.0 cable*
Windows 10 64-bit	✓	✓*	USB 2.0 cable
Windows 8.1 32-bit	✓	-	USB 2.0 cable
Windows 8.1 64-bit	✓	-	
Windows 7 32-bit SP1 or later	✓	-	USB 2.0 cable
Windows 7 64-bit SP1 or later	✓	-	

* Connect with the included USB 3.0 cable to use the USB 3.0 standard.

■ Mac

Supported operating systems	USB standard		USB cable connected
	USB 2.0	USB 3.0	
OS X El Capitan (10.11.2 or later)	✓	✓*	USB 3.0 cable* USB 2.0 cable
OS X Yosemite (10.10.1 or later)	✓	-	USB 2.0 cable
OS X Mavericks (10.9.5)	✓	-	USB 2.0 cable
OS X Mountain Lion (10.8.5)	✓	-	USB 2.0 cable

* Connect with the included USB 3.0 cable to use the USB 3.0 standard.

CAUTION

If you connect this unit to a computer via a USB hub, for example, audio signal dropouts, clicking noises and other interference could occur due to the influence of other USB devices connected to that hub. For this reason, we strongly recommend connecting this unit to a separate USB port. Connecting USB keyboards and mice, however, to the same bus should not be a problem.

Audio connections

Analog audio signals input into this device from mics, guitars, keyboards and other audio equipment can be converted into digital signals and transmitted to the computer via USB. In addition, by connecting speakers (through an amplifier if not powered) or headphones to this unit, you can monitor audio signals that are input to this unit and output from the computer.

CAUTION

Before connecting audio equipment, set the unit's 1–8 gain, LINE OUT 1-2 and PHONES 1/2 knobs to their lowest values. Failure to do so could cause sudden loud noises from monitoring equipment, and this could damage the equipment or harm hearing.

Microphones

■ Dynamic mics

Connect to the **IN1–IN8** jacks on the front of the unit.

■ Condenser mics

When using a condenser microphone that requires phantom power, connect it to an **IN1–IN8** jack and then set the phantom power switch to **+48V**.

CAUTION

- *Before making connections, turn this unit and all equipment to be connected off (standby).*
- *The phantom power switches set four input channels at a time. Do not set phantom power to +48V when connecting a mic that does not require phantom power.*
- *Set the LINE OUT 1–2 and PHONES 1/2 knobs to their minimum values before changing a phantom power switch setting. Failure to do so could cause sudden loud noises from monitoring equipment, and this could damage equipment or harm hearing.*
- *Do not connect or disconnect mics when the phantom power switch is set to +48V. Doing so could cause a loud noise and might damage this unit and connected equipment.*
- *Set the phantom power switch to +48V only when using a condenser microphone that requires phantom power. Setting phantom power to +48V when a dynamic mic or other mic that does not require it is connected could damage this unit and connected equipment.*
- *When using condenser mics that require phantom power and dynamic mics together, be sure to use balanced dynamic mics. Unbalanced dynamic mics cannot be used when phantom power is enabled.*
- *Supplying phantom power to some ribbon mics will break them. If you are unsure, do not supply phantom power to a ribbon mic.*

Guitar

When connecting a guitar or bass guitar directly to this unit, use the IN1 or IN2 jack on the front of the unit.

Electronic devices and other audio equipment

Connect electronic instruments and other audio equipment to the **IN3–IN8** jacks on the front of the unit and the **IN9–IN10** jacks on the back of the unit. Set the **LEVEL** switch for the **IN9–IN10** jacks to **–10dBV** when connecting unbalanced equipment and to **+4dBu** when connecting balanced equipment.

Analog record players

The output of an analog record player cannot be connected directly to this unit. To connect an analog record player to this unit, a phono amp and equalizer (or an audio amplifier that has phono input jacks) must be connected between them.

Monitor speakers

Connect monitor speakers (powered speakers or an amplifier and speaker system) to the **LINE OUT 1-2** jacks on the back of the unit.

Use the **LINE OUT 1-2** knob on the front of the unit to adjust the speaker volume.

Headphones

Connect headphones to the **PHONES 1** and **PHONES 2** jacks (standard stereo) on the front of the unit.

CAUTION

*Before connecting headphones, minimize the volumes with the **PHONES 1** and **PHONES 2** knobs. Failure to do so might cause sudden loud noises, which could harm your hearing or result in other trouble.*

MIDI connections

Connect sound modules, keyboards, synthesizers, drum machines and other MIDI devices to the unit in the following manner.

- If you want to monitor sound from a MIDI device, connect its outputs to the **IN1–IN8** jacks on the front of the unit or the **IN9–IN10** jacks on the back of the unit. You could also use an external mixer for monitoring.
- You can also use the **MIDI IN** and **MIDI OUT** connectors on the back of the unit to send and receive MIDI timecode (MTC). By doing this, you can use an application that supports MTC to synchronize a multitrack recorder (MTR) and MIDI devices.

CAUTION

*When using Windows Media Player, if the “Sound and Audio Devices Properties” Control Panel “MIDI music playback (default device)” is set to “Microsoft GS Wavetable SW Synth”, you will not be able to hear MIDI performances through this unit’s **LINE OUT 1–10**, **PHONES 1**, **PHONES 2**, **COAXIAL OUT** and **OPTICAL (S/MUX) OUT** connectors.*

Connecting with iOS devices

You can use a Lightning to USB Camera Adapter* to connect the unit to an iOS device and use it as an interface with that device.

* *You will need to prepare an Apple genuine Lightning to USB Camera Adapter (sold separately).

NOTE

- *When connected, this unit will not provide power to the iOS device.*
- *iOS does not support 176.4/192kHz sampling frequencies.*

6 – Using the Settings Panel

You can use the Settings Panel to change and save settings for the various functions of the unit.

Opening the Settings Panel

Open the Settings Panel installed on the computer to view it on the computer display.

You can open the Settings Panel in the following ways.

NOTE

The Settings Panel cannot be used with an iPad or other iOS device.

Windows OS

- Select the Settings Panel from “All Programs” or “All apps”

Windows 10

Right-click the Start button → All Programs → select “US-20x20 Settings Panel” under TASCAM and open the Settings Panel.

Windows 8.1

Click the button  that appears at the bottom left of the Start screen to open the Apps screen. On this screen, click the “US-20x20 Settings Panel” item under “TASCAM” to open the Settings Panel.

Windows 7

Start button → All Programs → select “US-20x20 Settings Panel” under TASCAM and open the Settings Panel.

- Open the Settings Panel from the Control Panel.

Windows 10

1. Right-click the Start button and select “Control Panel” to open the Control Panel.
2. If the Control Panel is showing categories, set the “View by:” item to “Large icons (L)” or “Small icons (S)”.
3. Select “US-20x20 Settings Panel” and open the Settings Panel.

Windows 8.1

1. Click the button  that appears at the bottom left of the Start screen to open the Apps screen, and select and open the Control Panel.
2. If the Control Panel is showing categories, set the “View by:” item to “Large icons (L)” or “Small icons (S)”.
3. Select “US-20x20 Settings Panel” and open the Settings Panel.

Windows 7

1. Click the Start button and select “Control Panel” to open the Control Panel.
2. If the Control Panel is showing categories, set the “View by:” item to “Large icons (L)” or “Small icons (S)”.
3. Select “US-20x20 Settings Panel” and open the Settings Panel.

Mac OS X

- Using the Finder, open the Applications folder and double-click “US-20x20 Settings Panel” to open the Settings Panel.

- In the Audio Devices window of the Audio MIDI Setup application, right-click (control-click) “US-20x20” (or click the settings icon when the unit name is selected) and click “Configure device...” to open the Settings Panel.

Settings Panel overview

The Settings Panel has three tabbed pages.

Click a tab at the top of the Settings Panel to open that page.

“MIXER”: Make built-in mixer and effect settings.

“INTERFACE”: Shows the current status of the driver and information about connections. Make various settings.

“OUTPUT SETTING”: Make output settings.

CAUTION

When you open the Settings Panel, the setting values on each page (“MIXER”, “INTERFACE”, and “OUTPUT SETTING”) will be the same as when last closed, but they have not been saved in a scene memory. To save settings in a scene memory, use the Scene Memory menu. (See “Using the SceneMemory menu” on page 25.)

6 – Using the Settings Panel

MIXER page

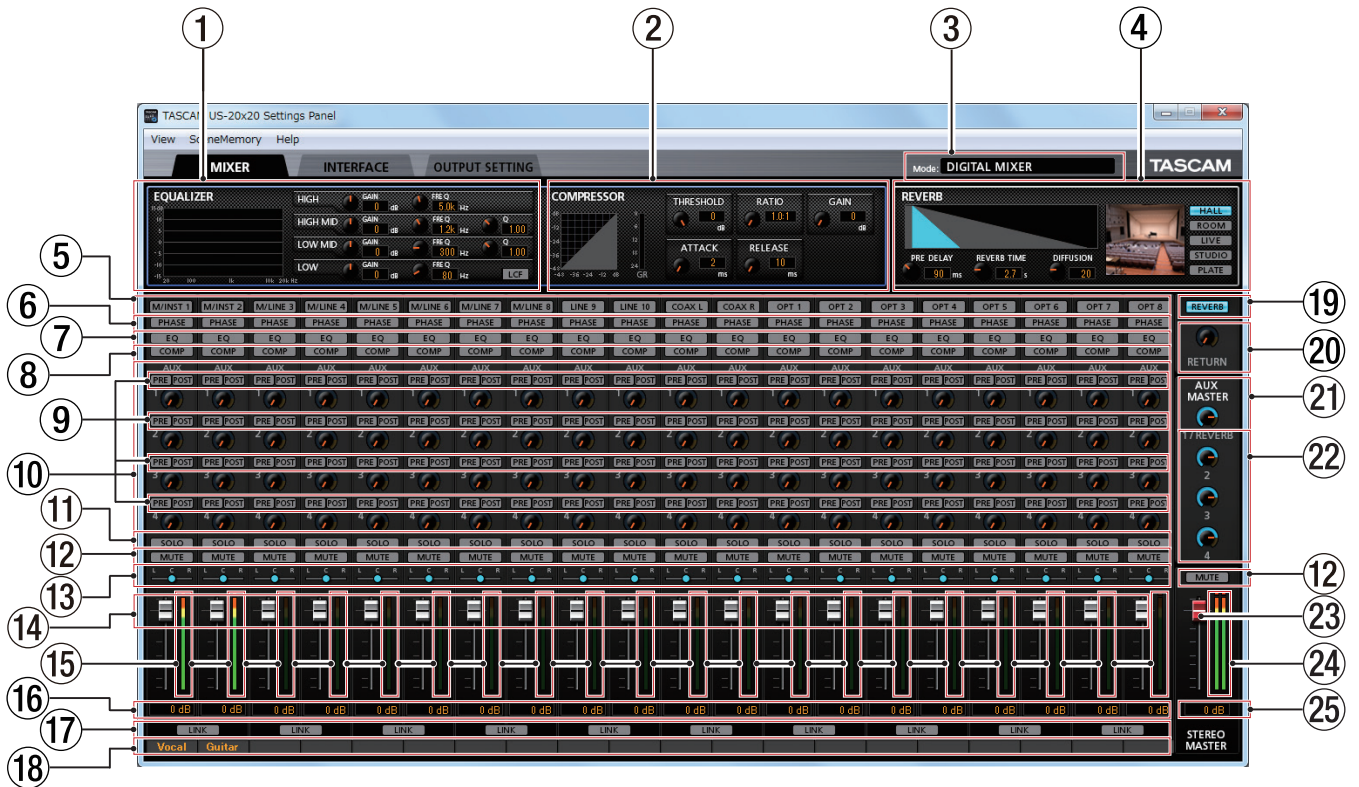

Windows Settings Panel screen

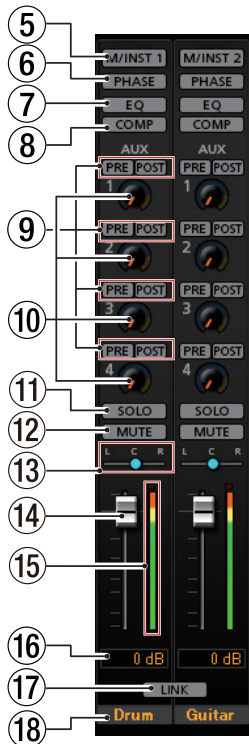

"MIXER" page channels 1-2

NOTE

When the unit is in MIC PRE mode, you cannot make settings on the "MIXER" page even if you click the "MIXER" tab. (See "Using the unit as a microphone preamp" on page 28.)

① EQUALIZER

This unit has a 4-band equalizer (with HIGH, HIGH MID, LOW MID and LOW bands).

Use the equalizer to increase or decrease the levels of specific frequency ranges. This can be used, for example, to enhance the sound of individual instruments, to adjust the balance of a wide frequency range and to cut specific unwanted frequencies. (See "EQUALIZER (4-band parametric EQ) display area overview" on page 18.)

Click the Select (5) button of a channel to make equalizer settings for it.

Equalizer settings are shown here for the channel selected using its Select (5) button.

6 – Using the Settings Panel

② COMPRESSOR

When the input volume exceeds the THRESHOLD level, the input volume is compressed, reducing output volume variation.

For example, by reducing the levels of sounds that are high level, lower level sounds become relatively louder, creating a more even volume level throughout and a more sustained sound. (See “COMPRESSOR display area overview” on page 19.)

Click the Select (⑤) button of a channel to make compressor settings for it.

Compressor settings are shown here for the channel selected using its Select (⑤) button.

NOTE

- *If the input is a stereo signal (stereo-linked channel or master), compression will start and be applied to both channels when either the left or right input channel exceeds the threshold level.*
- *When the compressor is off, the compressor curve will appear but the meters will not be active.*

③ Mode

This shows the operation mode of the unit set using the MODE button on its front panel.

④ REVERB

This effect adds reverberations to the original sound. Multiple sounds are delayed at various times with damping over time that is as natural as possible to produce reverberations like those of a hall, live-music club or studio, for example. (See “REVERB display area overview” on page 19.)

⑤ Select buttons

Click this button for a channel to show the equalizer and compressor settings for that channel.

Settings cannot be shown for more than one channel at a time.

Off (default): Select button unlit

ON: Select button lit

Activate one of these buttons to show the equalizer and compressor settings for that channel in the EQUALIZER (①) and COMPRESSOR (②) display areas.

To select a different channel, click that channel's button. The previously selected channel button will become unlit, and the newly selected channel button will light.

⑥ PHASE buttons

Use these to change the phases of the signals on each channel.

If the phase becomes reversed due to the wiring of microphones or other causes, click these buttons to reverse the phases of those channels.

PHASE button unlit (default)	Normal
PHASE button lit	Reversed

⑦ EQ buttons

Use these to turn the equalizer on/off for each channel.

Click an EQ button to activate the equalizer for that channel. The EQ button will light and the EQUALIZER (①) display area will show the active equalizer settings.

NOTE

The equalizer cannot be turned on if the sampling frequency is 176.4/192kHz.

⑧ COMP buttons

Use these to turn the compressor on/off for each channel.

Click a COMP button to activate the compressor for that channel. The COMP button will light and the COMPRESSOR (②) display area will show the active compressor settings.

NOTE

The compressor cannot be turned on if the sampling frequency is 176.4/192kHz.

⑨ Effects AUX selection buttons

Set whether the signal sent to the AUX bus is pre-fader or post-fader.

The selected button lights.

PRE button unlit	The signal is not sent to the AUX bus.
POST button unlit (default)	
PRE button lit	The signal is sent to the AUX bus before adjustment by the channel fader. The AUX level will not be affected by the channel fader.
POST button lit	The signal is sent to the AUX bus after adjustment by the channel fader. The AUX level will be affected by the channel fader.

⑩ AUX 1–4 knobs and indicators

Use to adjust the levels of the signals sent to the AUX bus (AUX levels).

Range: inf to 6 dB (default: inf)

Use the mouse to click and drag an AUX knob up or down to adjust that AUX level.

While dragging the mouse, the value being adjusted is shown below and to the right of the AUX knob.

The indicator lights blue at levels of 0 dB or less and yellow at levels from 0 dB to 6 dB.

⑪ SOLO buttons

The SOLO buttons change according to the current mode.

When the unit is in AUDIO I/F mode, if a channel is soloed (SOLO button turned on), channels that have not been soloed will automatically be muted (in place solo monitoring).

When the unit is in MIXER mode, channels that are soloed (SOLO buttons turned on) will be sent to the SOLO bus and channels that have not been soloed will automatically be muted (PFL solo monitoring).

The MUTE buttons of muted channels will light. (Default: off)

Multiple channels can also be soloed at the same time when the unit is in AUDIO I/F or MIXER mode.

NOTE

- *When the unit is in AUDIO I/F mode and all the SOLO buttons are off, clicking a SOLO button will solo that channel and automatically mute the other channels, lighting their MUTE buttons.*
- *When the unit is in AUDIO I/F mode if every SOLO button is turned off, channels that had been automatically muted will become unmuted. Channels that had been individually muted before any channel was soloed will remain muted.*
- *The MASTER L/R channel MUTE button will not turn on automatically when the unit enters solo mode.*

6 – Using the Settings Panel

12 MUTE buttons

Click a MUTE button to mute that channel. These buttons light for channels that are muted. (Default: off)

NOTE

In addition to turning the MUTE button on and off, channels will be automatically muted and unmuted when SOLO buttons are used

13 Pan sliders

Use to adjust the stereo positions of the signals input to each channel.

Use the mouse to click and drag a pan slider left or right to adjust the stereo position.

While dragging the mouse, the adjusted position is shown above the channel level fader (15).

The value is L20 when set all the way to the left, R20 when set all the way to the right and C when centered.

Setting range: L20–L1, C (default value), R1–R20 (41 steps total)

The pan slider appears blue when centered (C) and yellow at all other positions.

NOTE

- *When the pan slider is centered (C), signals are reduced by 3 dB and sent to the left and right buses.*
- *Double-click the pan slider to return it to the center (C) position.*
- *When the pan slider is at the left end (L20), the signal is sent only to the left bus of the stereo bus. It is not sent to the right bus.*
- *When the pan slider is at the right end (R20), the signal is sent only to the right bus of the stereo bus. It is not sent to the left bus.*

14 Channel faders

Use these to adjust the levels of the signals sent from each channel to the stereo bus.

Range: –infinity to 6 dB (default: –infinity)

Use the mouse to click and drag a channel fader up or down to adjust its level.

The gain value of the channel fader is shown in the fader level display area (16).

NOTE

Double-click the fader to set it to 0 dB.

15 Channel level meters

These meters show the signal levels of each channel.

The channel level meters appear green at levels of -12 dB or less, yellow at levels from -12 dB to -6 dB and red at levels above -6 dB.

Each level meter has an overload indicator at its top.

NOTE

The channel meters show the levels before being adjusted by the faders. Level meters are not affected by fader adjustments or even their channels being muted.

16 Fader level display areas

These show the levels of the channel faders above them as decibel values.

17 LINK buttons

Click a LINK button to unite odd and even channels as a single stereo channel. When linked, this button lights for those channels. (Default: unlit)

When a pair is stereo linked, the buttons and knobs of the channels are combined. The channel level meters are also shown as a stereo pair.

See “LINK button overview” on page 20 for details.

18 Channel notes

You can input up to six alphanumeric characters.

• Character input

Click one of these areas. The cursor will blink when ready for input.

When the unit is ready, use a computer keyboard to input characters.

When done inputting, press the computer Enter key to confirm.

- *When done inputting characters, you must press the computer Enter key to confirm. If you do not press the Enter key, the input characters will continue to be shown but will not be saved when you switch to a different page from the “MIXER” page.*

19 REVERB button

Click the REVERB button to apply reverb. (Default: on)

When the reverb is on, the REVERB button lights.

NOTE

The reverb cannot be turned on if the sampling frequency is 176.4/192kHz.

20 RETURN knob and indicator

Use to adjust the return level, which is the signal from the reverb effect returned to the stereo bus.

Range: inf to 6 dB (default: inf)

Use the mouse to click and drag the Return knob up or down to adjust the level.

While dragging the mouse, the value being adjusted is shown to the bottom right of the RETURN knob.

The indicator lights blue at levels of 0 dB or less and yellow at levels from 0 dB to 6 dB.

21 AUX MASTER 1/REVERB knob and indicator

Use this to adjust the send master level of the signal sent to the AUX 1 bus and reverb effect.

Range: inf to 6 dB (default: 0 dB)

Use the mouse to click and drag the 1/REVERB knob up or down to adjust the send level.

While dragging the mouse, the value being adjusted is shown below and to the right of the 1/REVERB knob.

The indicator lights blue at levels of 0 dB or less and yellow at levels from 0 dB to 6 dB.

6 – Using the Settings Panel

22 AUX MASTER 2–4 knobs and indicators

Use these to adjust the send master levels of the signals sent to the AUX 2–4 buses.

Range: inf to 6 dB (default: 0 dB)

Use the mouse to click and drag the 2–4 knobs up or down to adjust the send levels.

While dragging the mouse, the value being adjusted is shown below and to the right of the 2–4 knobs.

The indicator lights blue at levels of 0 dB or less and yellow at levels from 0 dB to 6 dB.

23 STEREO MASTER fader

Use to adjust the level of the output signal.

Use the mouse to click and drag the master fader up or down to adjust the master level.

The value being adjusted is shown in the master fader level display area (25).

24 STEREO MASTER level meters

The master levels are shown by this stereo level meter.

The STEREO MASTER level meters appear green at levels of -12 dB or less, yellow at levels from -12 dB to -6 dB and red at levels above -6 dB.

Each level meter has an overload indicator at its top.

NOTE

The master level meters show the levels after being adjusted by the fader (post fader). The level meters are affected by fader adjustments and channels being muted.

25 STEREO MASTER fader level display area

This shows the level of the master fader as a numerical decibel value.

EQUALIZER (4-band parametric EQ) display area overview

Use this to increase or decrease the levels of specific frequency ranges. This can be used, for example, to enhance the sound of individual instruments, to adjust the balance of a wide frequency range and to cut specific unwanted frequencies.

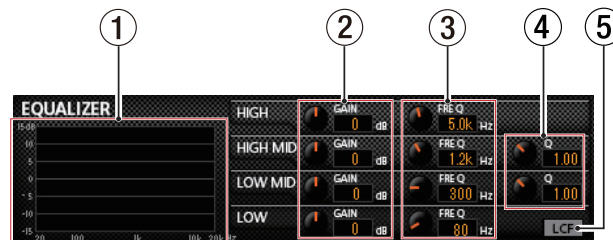

The equalizer has a high-shelf HIGH band, a low-shelf LOW band and peaking (bell-shaped) HIGH MID and LOW MID bands.

1 EQ graph

The frequency response at the current settings is shown as a graph.

The graph is shown even when the equalizer is off.

2 GAIN (HIGH/HIGH MID/LOW MID/LOW) knobs

Set the amount the levels are increased or decreased for the HIGH, HIGH MID, LOW MID and LOW bands.

Range: ± 12 dB (default: 0 dB)

3 FREQ (HIGH/HIGH MID/LOW MID/LOW) knobs

Set the cutoff frequencies of the HIGH, HIGH MID, LOW MID and LOW bands.

Ranges

HIGH: 1.7 kHz – 18.0 kHz (default: 5 kHz)

HIGH MID: 32 Hz – 18.0 kHz (default: 1.2 kHz)

LOW MID: 32 Hz – 18.0 kHz (default: 300 Hz)

LOW: 32 Hz – 1.6 kHz (default: 80 Hz)

4 Q (HIGH MID/LOW MID) knobs

Set the acutenesses of the peaks of the HIGH MID and LOW MID bands.

The higher the value the more acute it becomes, making it affect a narrower frequency band. The lower the value, the less acute it becomes, making it affect a broader frequency band.

Ranges

HIGH MID: 0.25 – 16.00 (default: 1.00)

LOW MID: 0.25 – 16.00 (default: 1.00)

5 LCF button

Click the LCF button to enable a low cut filter that cuts noise and other sounds at low frequencies. The LCF button lights when enabled. (Default: off)

6 – Using the Settings Panel

COMPRESSOR display area overview

When the input volume exceeds the THRESHOLD level, the input volume is compressed, reducing output volume variation.

For example, by reducing the levels of sounds that are high level, lower level sounds become relatively louder, creating a more even volume level throughout and a more sustained sound.

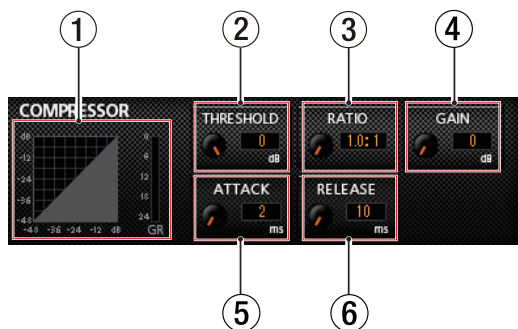

① Compressor status display

Three meters show the level of the signal input to the compressor (INPUT), the level of the signal output from the compressor (OUTPUT) and the gain reduction caused by the compressor (GR).

② THRESHOLD knob

Sets the threshold level that will cause the compressor to start.

Range: -32 dB – 0 dB (default: 0 dB)

③ RATIO knob

Sets the compression ratio for the input volume.

Turning it right raises the compression ratio, increasing the amount of compression.

Range: 1.0:1 – inf:1 (default: 1.0:1)

④ GAIN knob

Sets the gain of the output signal.

When the volume is compressed, the output level becomes lower than the input level. Use the GAIN knob to increase the output level so that it is close to the input level.

Range: 0 dB – 20 dB (default: 0 dB)

⑤ ATTACK knob

Sets the amount of time until the compression reaches the compression RATIO setting after the input volume exceeds the threshold.

Range: 2 ms – 200 ms (default: 2 ms)

⑥ RELEASE knob

Sets the amount of time until the compression stops and the sound returns to its uncompressed level after the input sound goes below the threshold.

Range: 10 ms – 1000 ms (default: 10 ms)

NOTE

- If the input is a stereo signal (stereo-linked channel or master), compression will start and be applied to both channels when either the left or right input channel exceeds the threshold level.
- When the compressor is off, the compressor curve will appear but the meters will not be active.

REVERB display area overview

This effect adds reverberations to the original sound. Multiple sounds are delayed at various times with damping over time that is as natural as possible to produce reverberations like those of a hall, live-music club or studio, for example.

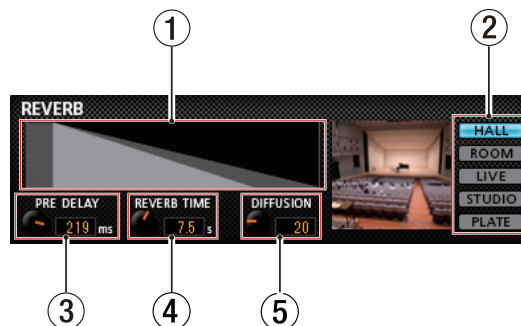

① Reverb status display

This shows the setting status of the PRE DELAY and REVERB TIME knobs.

② Reverb type switch

Use to select the type of reverb.

Depending on the type, the density and level of the reverb sound changes.

Options: HALL (default), ROOM, LIVE, STUDIO, PLATE

③ PRE DELAY knob

Set the amount of delay until the first reverberations.

The larger the value, the larger the reverberations make the room sound.

Range: 0 ms – 250 ms (default: 90 ms)

④ REVERB TIME knob

Set the amount of time that the reverberations continue.

The larger the value, the longer they continue.

Range: 0.1 s – 10 s (default: 2.7 s)

⑤ DIFFUSION knob

Sets the breadth of the reverberations.

Range: 0 – 100 (default: 20)

6 – Using the Settings Panel

LINK button overview

When a LINK button on the “MIXER” page is turned on/off, the settings differ according to whether the stereo link is enabled or disabled.

The details of the settings are as follows.

■ When a LINK button is turned on

Button/knob	Setting status
Select buttons	On if a Select button was on (lit) for either channel. Off if the Select buttons were off (unlit) for both channels.
PHASE buttons	Settings are not combined. Both channels retain their previous settings.
EQ buttons	The setting of the odd channel is used for both.
COMP buttons	The setting of the odd channel is used for both.
Effect AUX selection buttons	The setting of the odd channel is used for both.
AUX knobs (1–4)	The setting of the odd channel is used for both.
SOLO buttons	The setting of the odd channel is used for both.
MUTE buttons	The setting of the odd channel is used for both.
Pan sliders	Settings are not combined. Odd and even channels can each be set independently.
Channel faders	The setting of the odd channel is used for both.
Channel level meters	The channel level meters are shown as a stereo pair.
Fader level display areas	The setting of the odd channel is shown.

NOTE

When a LINK button is turned on (lit), the select button name changes to a name used when the stereo link is active.

Examples

When the “M/INST 1” and “M/INST 2” buttons are linked, the name of the button changes to “M/INST 1-2”.

■ When a LINK button is turned off

Button/knob	Setting status
Select buttons	If the Select button was on (lit) for either channel, the odd channel will be turned on and the even channel will be turned off. If the Select buttons were off (unlit) for both channels, they will both stay off.
PHASE buttons	Settings do not change. Both channels retain their previous settings.
EQ buttons	Both channels use the settings they shared when stereo-linked.
COMP buttons	Both channels use the settings they shared when stereo-linked.
Effect AUX selection buttons	Both channels use the settings they shared when stereo-linked.
AUX knobs (1–4)	Both channels use the settings they shared when stereo-linked.
SOLO buttons	If a SOLO button was on (lit) when stereo-linked, this button will be on for both channels. If the SOLO buttons were off (unlit) for both channels, they will both stay off.
MUTE buttons	If a MUTE button was on (lit) when stereo-linked, this button will be on for both channels. If the MUTE buttons were off (unlit) for both channels, they will both stay off.
Pan sliders	Both channels use the settings they shared when stereo-linked.
Channel faders	Both channels use the settings they shared when stereo-linked.
Channel level meters	The channel level meters are shown independently again.
Fader level display areas	These setting values of each channel are shown.

6 – Using the Settings Panel

INTERFACE page

Windows

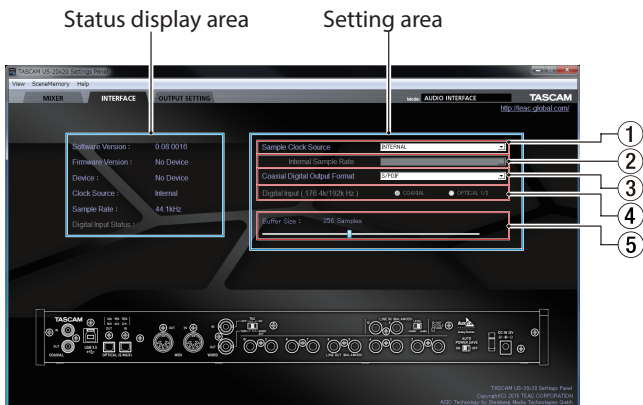

Windows "INTERFACE" page in AUDIO I/F mode

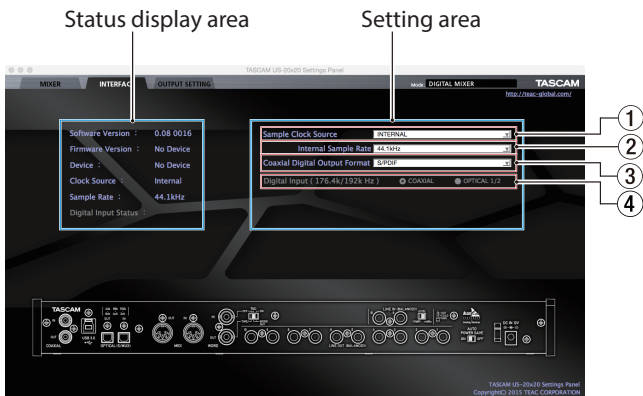

Mac "INTERFACE" page in AUDIO I/F mode

The "INTERFACE" page is divided into two areas. One shows the status of the unit and the other shows settings.

An image of the rear panel of the unit is shown at the bottom of the page so you can check the layout of connectors, for example. (No setting changes or other operations are possible using this image.)

Status display area

This shows the current status of the unit.

Item displayed	Meaning
Software Version	Version of the software being used
Firmware Version	Version of the firmware used by the unit
Device	Unit model
Clock Source	Name of the currently selected clock source
Sample Rate	Current sampling frequency
Digital Input Status	Current status of digital input

Depending on the status of the digital input, the following will appear for the Digital Input Status item.

Item displayed	Meaning
Lock	A valid digital signal is being input.
Unlock	No valid digital signal is being detected.

NOTE

- ("No Device" is shown for the "Firmware Version" and "Device" items when the unit and the computer are not connected.)
- "No ASIO Driver" is shown for the "Sample Rate" item if no ASIO driver has been installed.

Setting area

① Sample Clock Source

Use this to set the sampling clock source.

Options:

COAXIAL

The clock signal input through the **COAXIAL IN** connector is used.

OPTICAL(TASCAM Auto Mode)

The clock signal input through the **OPTICAL IN** connector is used.

If the connected device is a TASCAM device, the input clock signal will be automatically identified and set.

OPTICAL(44.1kHz/48kHz/88.2kHz/96kHz)

The clock signal input through the **OPTICAL IN** connector is used.

Use this setting if the connected device is not a TASCAM device and the input clock signal is 44.1, 48, 88.2 or 96 kHz.

OPTICAL(176.4kHz/192kHz)

The clock signal input through the **OPTICAL IN** connector is used.

Use this setting if the connected device is not a TASCAM device and the input clock signal is 176.4 or 192 kHz.

WORD

The clock signal input through the **WORD IN** connector is used.

INTERNAL

The unit's built-in clock is always used.

NOTE

- When set to COAXIAL, OPTICAL or WORD, if no signal is input through the corresponding connector or synchroni-

6 – Using the Settings Panel

zation becomes impossible, “Unlock” will appear for the Digital Input Status item and the unit's MODE indicator will blink.

- When connecting multiple digital devices to the US-20x20, synchronize them to a system word clock and input word clock supplied by the master clock device to the US-20x20.

② Internal Sample Rate

Set the sampling frequency of the unit's internal clock.

Options: 44.1kHz, 48kHz, 88.2kHz, 96kHz, 176.4kHz, 192kHz

NOTE

When the unit is in AUDIO I/F mode, you cannot set the Internal Sample Rate.

③ Coaxial Digital Output Format

Use this to set the digital output format.

Options: S/PDIF, AES/EBU

④ Digital Input (176.k/192k Hz)

Use this to set the digital input destination. (Only when 176.4/192 kHz)

Options: COAXIAL, OPTICAL 1/2

⑤ Buffer Size (Windows only)

The Windows driver for the unit stores the audio signals transferred to and from the computer temporarily in a buffer. This buffer size can be adjusted.

Smaller buffer sizes result in less audio signal delay (latency), but require high-speed processing by the computer.

If the processing cannot keep up, for example, due to other system operations, clicking and popping noises might occur and the audio signal might even drop out.

Increasing the buffer size will stabilize operation and suppress negative effects on audio signals, but the delay in audio signals sent to the computer will increase.

You can use the slider on the panel to adjust the buffer size, according to the use conditions.

Use the slider to select fixed values that increase from left to right.

Options: 64 Samples, 128 Samples, 256 Samples, 512 Samples, 1024 Samples, 2048 Samples

NOTE

When the unit is in MIC PRE or MIXER mode, you cannot set the Buffer Size.

OUTPUT SETTING page

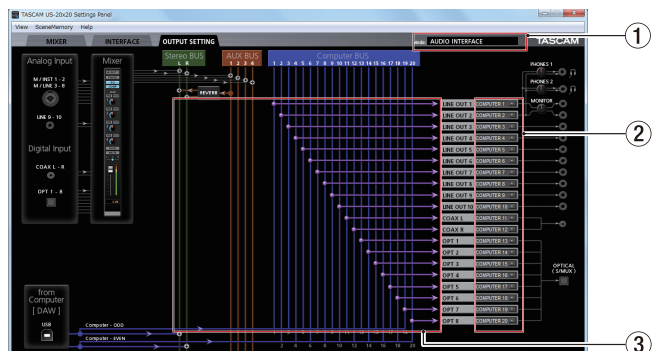

Windows Settings Panel page in AUDIO I/F mode

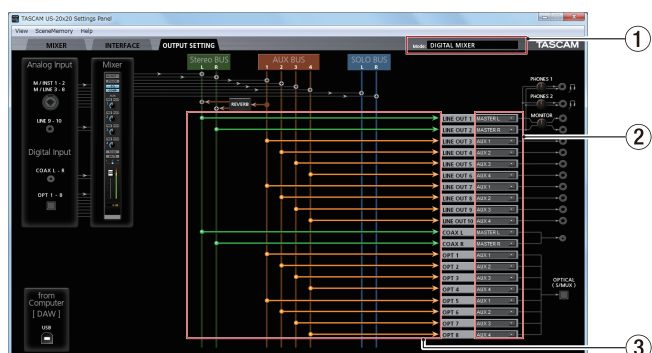

Windows Settings Panel page in MIXER mode

On the “OUTPUT SETTING” page, set the signal lines output from the unit's output jacks.

NOTE

When the unit is in MIC PRE mode, you cannot change settings in the output signal selection area of the “OUTPUT SETTING” page. (See “Using the unit as a microphone preamp” on page 28.)

① Mode

This shows the operation mode of the unit set using the MODE button on its front panel.

② Output signal selection area

Click the output signal selection area to open a pull-down menu from which you can select the signal you want to output from the options. The options shown depend on the operation mode.

Options:

MASTER L/MASTER R

Output the L/R signals from the Stereo BUS

AUX 1–AUX 4

Output the signals from an AUX BUS (1–4)

COMPUTER 1–COMPUTER 20

When the operation mode is AUDIO I/F, signals are output from Computer BUS (1–20)

SOLO L/SOLO R:

When the operation mode is MIXER, signals are output from SOLO BUS (L/R).

6 – Using the Settings Panel

NOTE

The same signals are output from the PHONES 1 and PHONES 2 jacks as the output signals selected in the output signal selection area for LINE OUT 1 and LINE OUT 2.

③ Status display area

This shows the connections between the signals selected in the output signal selection area (②) and the output connectors.

Using the Settings Panel View menu

Use the View menu in the menu bar to reset the Settings Panel and reverb settings to their original values, as well as to minimize the Settings Panel.

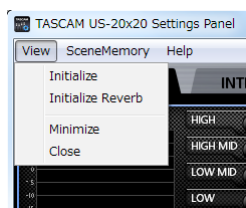

Windows version

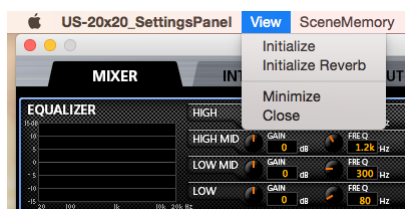

Mac version

■ Initialize

Select this to reset all settings in the Settings Panel. See “Initializing the Settings Panel” on page 23 for details.

■ Initialize Reverb

Select this to reset the settings in REVERB area on the “MIXER” page. See “Resetting the reverb settings” on page 24 for details.

■ Minimize

This minimizes the Settings Panel software to the Windows Taskbar or Mac Dock.

■ Close

Close the Settings Panel and quit/exit the software.

Initializing the Settings Panel

You can reset all settings in the Settings Panel.

NOTE

The items on the “INTERFACE” page cannot be initialized.

CAUTION

After resetting, you cannot restore the previous settings.

1. In the menu bar, open the View menu (Windows/Mac), and click “Initialize”.

The following confirmation message will appear.

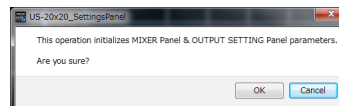

Windows version

2. Click the “OK” button in the message window to reset the Settings Panel settings to their default values.

The items reset are as follows.

“MIXER” page items

- EQUALIZER area settings: all initialized
- COMPRESSOR area settings: all initialized
- REVERB area settings: all initialized
- PHASE buttons (all channels): off
- EQ buttons (all channels): off
- COMP buttons (all channels): off
- Effect AUX selection buttons: off
- AUX 1–4 knobs (all channels): inf
- SOLO buttons (all channels): off
- MUTE buttons (all channels): off
- Pan sliders (all channels): center (C)
- Channel faders (all channels): –infinity
- LINK buttons (all channel pairs): off
- REVERB buttons: on
- RETURN knob: inf
- AUX MASTER 1/REVERB knob: 0
- AUX MASTER 2–4 knobs: 0
- STEREO MASTER fader: –infinity

The following “OUTPUT SETTING” page items when the unit is in AUDIO I/O mode

- LINE OUT 1: COMPUTER 1
- LINE OUT 2: COMPUTER 2
- LINE OUT 3: COMPUTER 3
- LINE OUT 4: COMPUTER 4
- LINE OUT 5: COMPUTER 5
- LINE OUT 6: COMPUTER 6
- LINE OUT 7: COMPUTER 7
- LINE OUT 8: COMPUTER 8
- LINE OUT 9: COMPUTER 9
- LINE OUT 10: COMPUTER 10
- COAX L: COMPUTER 11
- COAX R: COMPUTER 12
- OPT 1: COMPUTER 13
- OPT 2: COMPUTER 14
- OPT 3: COMPUTER 15
- OPT 4: COMPUTER 16

6 – Using the Settings Panel

- OPT 5: COMPUTER 17
- OPT 6: COMPUTER 18
- OPT 7: COMPUTER 19
- OPT 8: COMPUTER 20

The following “OUTPUT SETTING” page items when the unit is in MIXER mode

- LINE OUT 1: MASTER L
- LINE OUT 2: MASTER R
- LINE OUT 3: AUX 1
- LINE OUT 4: AUX 2
- LINE OUT 5: AUX 3
- LINE OUT 6: AUX 4
- LINE OUT 7: AUX 1
- LINE OUT 8: AUX 2
- LINE OUT 9: AUX 3
- LINE OUT 10: AUX 4
- COAX L: MASTER L
- COAX R: MASTER R
- OPT 1: AUX 1
- OPT 2: AUX 2
- OPT 3: AUX 3
- OPT 4: AUX 4
- OPT 5: AUX 1
- OPT 6: AUX 2
- OPT 7: AUX 3
- OPT 8: AUX 4

NOTE

- Click the “Cancel” button to return to the Settings Panel without resetting.
- If you turn the unit on without launching the Settings Panel, the default values for the “OUTPUT SETTING” page will be used for the input and output settings.
- There is no iOS device Settings Panel, so the unit will operate using the default values.

Resetting the reverb settings

You can reset the settings in the REVERB area on the “MIXER” page.

CAUTION

After resetting, you cannot restore the previous settings.

1. In the menu bar, open the View menu (Windows/Mac), and click “Initialize Reverb”.

The following confirmation message will appear.

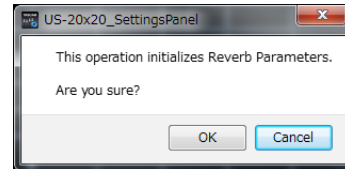

Windows version

2. Click the “OK” button in the message window to reset the reverb settings to their default values.

The items reset are as follows.

Reverb type	Reverb knobs		
	PRE DELAY	REVERB TIME	DIFFUSION
HALL	90 ms	2.7 s	20
ROOM	25 ms	1.4 s	60
LIVE	6 ms	2.6 s	50
STUDIO	60 ms	0.4 s	70
PLATE	42 ms	2.7 s	50

The reverb type will also be set to HALL (default value).

NOTE

Click the “Cancel” button to return to the Settings Panel without resetting.

6 – Using the Settings Panel

Using the SceneMemory menu

Use the “SceneMemory” menu to save the current Settings Panel settings in a scene memory or to initialize those settings.

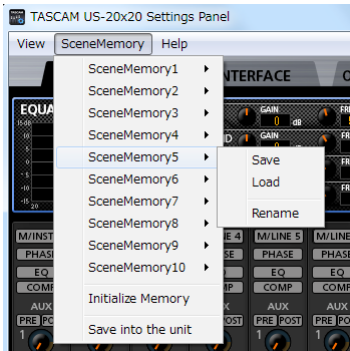

Windows version

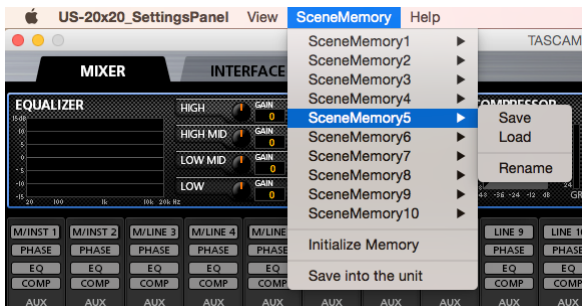

Mac version

■ SceneMemory1–10 items

Use to save the current Settings Panel settings as a scene memory. Ten scene memories have been prepared in advance.

■ Initialize Memory item

Use to reset all scene memories to their default values. See “Resetting all scene memories” on page 27 for details.

■ Save into the unit item

You can transfer the current Settings Panel settings to the unit.

By transferring the settings saved in the Settings Panel to the unit, you can use them to operate the unit in standalone mode when it is not connected to a computer by USB.

See “Saving Settings Panel settings to the unit” on page 27 for details.

NOTE

The Buffer Size item on the “INTERFACE” page is not saved.

Saving Settings Panel settings

You can save the current Settings Panel settings as a scene memory.

CAUTION

Only one set of Settings Panel settings can be saved in each scene memory. For this reason, saving settings will erase the previously saved settings.

1. Open the “SceneMemory” menu from the menu bar, and click the name of the scene memory where you want the settings to be saved to open a submenu.
2. Click “Save” in the submenu to save the current Settings Panel settings to the selected scene memory.

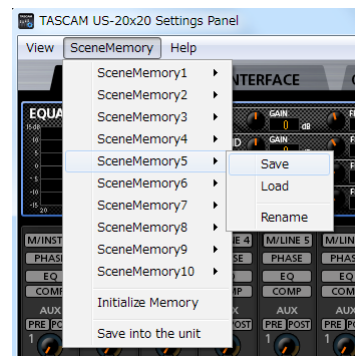

Windows version

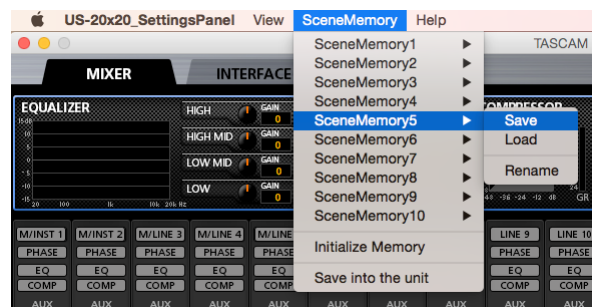

Mac version

NOTE

Select button settings on the “MIXER” page are not saved.

6 – Using the Settings Panel

Loading Settings Panel settings

You can change the current Settings Panel settings by loading settings stored in a scene memory.

CAUTION

After loading a scene memory, you cannot restore the previous settings. You can save the current settings in a different scene memory beforehand if you like.

1. Open the “SceneMemory” menu from the menu bar, and click the name of the scene memory to be loaded to open a submenu.
2. Click “Load” in the submenu to change the Settings Panel settings to the settings in the selected scene memory.

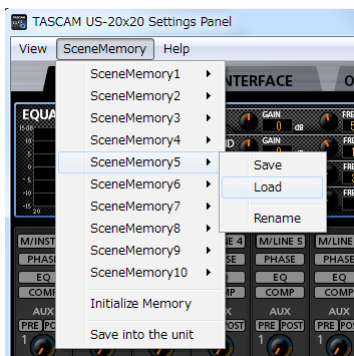

Windows version

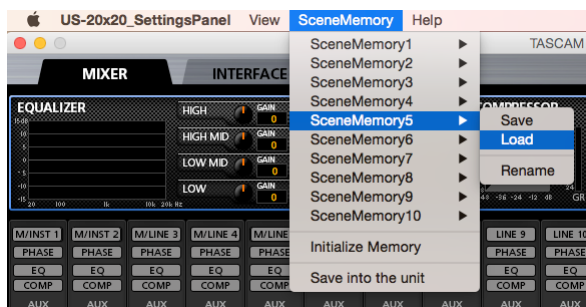

Mac version

CAUTION

A scene memory that has never been saved contains no Settings Panel settings. If you try to load such a scene, the following message will appear.

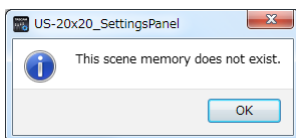

Windows version

Changing scene memory names

You can change the names of scene memories.

1. Open the “SceneMemory” menu from the menu bar, and click the scene memory name that you want to change to open a submenu.
2. Select “Rename” in the submenu.

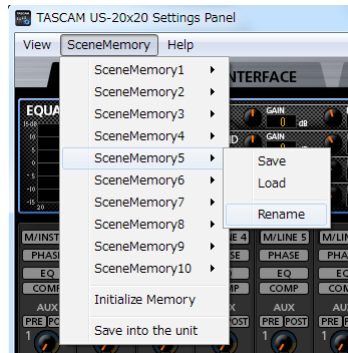

Windows version

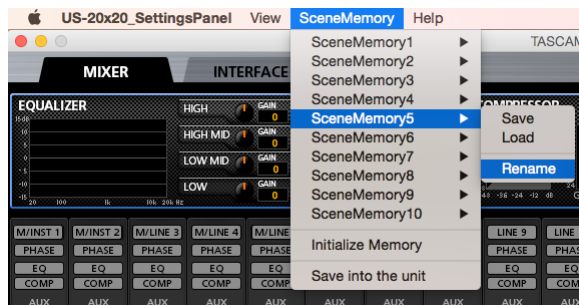

Mac version

3. A window where you can change the scene memory name will open.

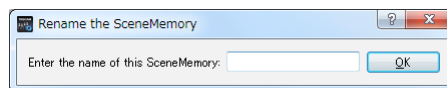

Windows version

4. Input a new name for the scene memory, and click the “OK” button to confirm the change.

6 – Using the Settings Panel

Resetting all scene memories

You can reset the 10 scene memories to the default values.

CAUTION

After resetting, you cannot restore the previous settings.

1. In the menu bar, open the “SceneMemory” menu, and click “Initialize Memory”.

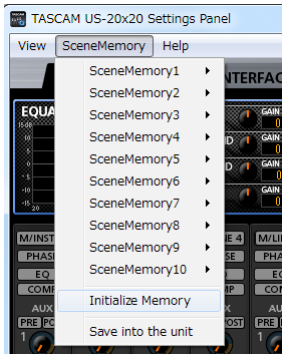

Windows version

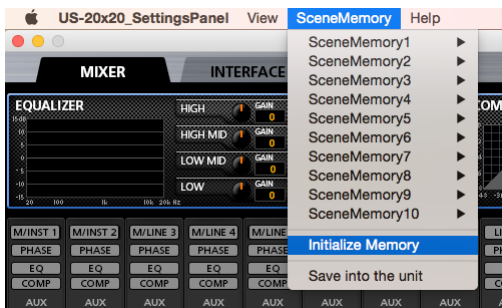

Mac version

2. The following confirmation message, which explains that all scene memories will be reset, will appear.

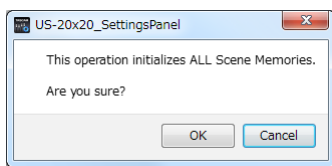

Windows version

3. Click the “OK” button to initialize all the scene memories.

NOTE

Click the “Cancel” button to return to the Settings Panel without initializing the 10 scene memories.

Saving Settings Panel settings to the unit

You can save the current Settings Panel settings to the unit.

1. In the menu bar, open the “SceneMemory” menu, and click “Save into the unit”.

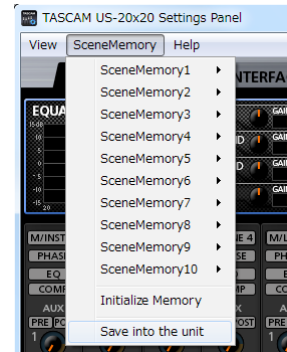

Windows version

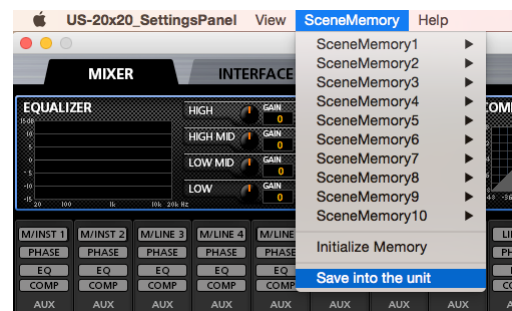

Mac version

2. The following confirmation message, which explains that all the current Settings Panel settings will be saved to the unit, will appear.

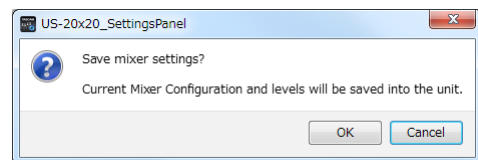

Windows version

3. Click the “OK” button on the screen to save all the current Settings Panel settings to the unit memory.

NOTE

The Buffer Size item on the “INTERFACE” page is not saved.

7 – Operation modes

Press the **MODE** button on the front of the unit to change the operation mode used.

The **MODE** indicator lights for the currently active operating mode.

This unit has the following three operating modes.

- MIC PRE

The unit operates as a microphone preamp.

- AUDIO I/F

The unit operates as an audio interface.

- MIXER

The unit operates as a digital mixer.

Using the unit as a microphone preamp

When the **MIC PRE MODE** indicator on the front of the unit is lit, you can use the unit as a microphone preamp.

NOTE

- *The default sampling frequency in mic preamp mode is 44.1 kHz.*
- *When the unit is in mic preamp mode, you cannot make settings on the “MIXER” page. If you click the “MIXER” tab, the following message will appear.*

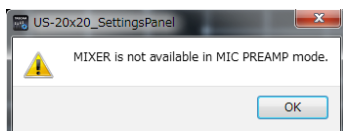

- *When the unit is in mic preamp mode, you cannot change settings in the output signal selection area of the “OUTPUT SETTING” page. The following message will appear if you try to change the settings. (See “OUTPUT SETTING page” on page 22.)*

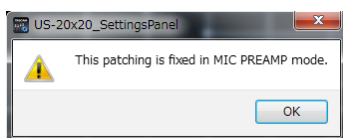

Changing the sampling frequency in mic preamp mode

Use the following settings to change the sampling frequency (44.1 kHz by default) in mic preamp mode.

■ Windows

Control Panel → Sound window → Speakers TASCAM US-20x20 → Properties (p) → US-20x20 Properties Advanced tab → Default Format

■ Mac

Applications folder → Utilities folder → Audio MIDI Setup → Audio Devices window → US-20x20 → Format

NOTE

In mic preamp mode, the sampling frequency can also be changed from DAW software.

Input and output channels in mic preamp mode

In mic preamp mode, the routings between input and output channels are fixed as shown below.

The input channels that can be output from the **OPTICAL OUT** jacks depends on the set sampling frequency.

	Input			Output
	44.1/48 kHz	88.2/96 kHz	176.4/192 kHz	
MIC/INST IN1	MIC/INST IN1	MIC/INST IN1	MIC/INST IN1	LINE OUT 1
MIC/INST IN2	MIC/INST IN2	MIC/INST IN2	MIC/INST IN2	LINE OUT 2
MIC/LINE IN3	MIC/LINE IN3	MIC/LINE IN3	MIC/LINE IN3	LINE OUT 3
MIC/LINE IN4	MIC/LINE IN4	MIC/LINE IN4	MIC/LINE IN4	LINE OUT 4
MIC/LINE IN5	MIC/LINE IN5	MIC/LINE IN5	MIC/LINE IN5	LINE OUT 5
MIC/LINE IN6	MIC/LINE IN6	MIC/LINE IN6	MIC/LINE IN6	LINE OUT 6
MIC/LINE IN7	MIC/LINE IN7	MIC/LINE IN7	MIC/LINE IN7	LINE OUT 7
MIC/LINE IN8	MIC/LINE IN8	MIC/LINE IN8	MIC/LINE IN8	LINE OUT 8
MIC/INST IN1-2 + MIC/LINE IN3-8	MIC/INST IN1-2 + MIC/LINE IN3-4	MIC/INST IN1-2	MIC/INST IN1-2	OPTICAL OUT
MIC/INST IN1-2	MIC/INST IN1-2	MIC/INST IN1-2	MIC/INST IN1-2	COAXIAL OUT
MIC/INST IN1-2	MIC/INST IN1-2	MIC/INST IN1-2	MIC/INST IN1-2	LINE OUT 9-10

You can use the gain knobs of the channels to adjust each of their output levels.

NOTE

When shipped new from the factory, the LINE OUT 1–2 knobs are set at their minimum values, so no signals will be output from the LINE OUT 1–2 jacks.

When using mic preamp mode, set the LINE OUT 1–2 knobs to their maximum values.

Using the unit in audio interface mode

When the **AUDIO I/F MODE** indicator on the front of the unit is lit, you can use the unit as an audio interface.

NOTE

The default sampling frequency in audio interface mode is 44.1 kHz.

Changing the sampling frequency in audio interface mode

Set it in the DAW software you are using. **Using the unit in digital mixer mode**

When the **MIXER MODE** indicator on the front of the unit is lit, you can use the unit as a digital mixer.

NOTE

The default sampling frequency in digital mixer mode is 44.1 kHz.

The sampling frequency can be changed in digital mixer mode.

You can change the sampling frequency (44.1 kHz by default) in digital mixer mode in the following manner.

■ Windows

Control Panel → Sound window → Speakers TASCAM US-20x20 → Properties (p) → US-20x20 Properties Advanced tab → Default Format

■ Mac

Applications folder → Utilities folder → Audio MIDI Setup → Audio Devices window → US-20x20 → Format

NOTE

In digital mixer mode, the sampling frequency can also be changed from DAW software.

Making settings without the Settings Panel

This unit is designed to allow basic settings to be made using the Settings Panel. Even when the Settings Panel is not available, however, clock source and AD/DA mode settings can be made using hardware controls.

These functions are provided for emergency situations when a computer is unavailable.

Making settings using hardware controls

1. Turn the unit on while pressing the **MODE** button. The **MIC PRE**, **AUDIO I/F** and **MIXER MODE** indicators and the Input 1 signal/overload indicator light.

signal/overload indicator

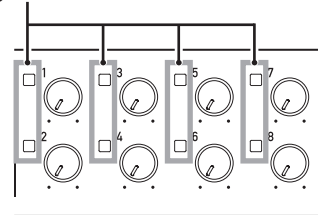

2. Press the **MODE** button to change the lit signal/overload indicators and choose the desired clock source and mic preamp mode. The lit signal/overload indicators (1–8) show the unit's operation state as follows.

Indicator number	Status when indicator lit
1	Sample clock set to INTERNAL. The built-in 44.1kHz clock is used. 88.2kHz clock is used when indicator 5 is lit. 176.4kHz clock is used when indicator 7 is lit.
2	The clock signal input through the COAXIAL IN connector is used as the sampling clock source.
3	Sample clock set to INTERNAL. The built-in 48kHz clock is used. 96kHz clock is used when indicator 5 is lit. 192kHz clock is used when indicator 7 is lit.
4	The clock signal input through the OPTICAL IN connector is used as the sampling clock source. Indicator 5 must also be lit if a double-rate (88.2/96kHz) clock signal is input. Indicator 7 must also be lit if a quadruple-rate (176.4/192kHz) clock signal is input.
5	Use a double-rate (88.2/96kHz) sampling clock source.
6	The clock signal input through the WORD IN connector is used as the sampling clock source.
7	Use a quadruple-rate (176.4/192kHz) sampling clock source.
8	Use the DA (digital input to analog output) mic preamp mode. When unlit, the AD (analog input to digital output) mode is used.

Example: Two indicators (1 and 5) light when set to use 88.2kHz internal clock.

NOTE

- *The clock source and mic preamp modes cannot be set separately.*
 - *If the unit is not used for some time, it will revert to ordinary powered-on status. In this case, the settings last set using the "Save into the unit" item will become active. (See "Saving Settings Panel settings to the unit" on page 27.)*
3. Press and hold the **MODE** button to confirm. The signal/overload indicators for the selected setting will blink.

8 – Application Guide

In this chapter, we explain how to set some audio applications for use with this unit.

DAW software

The ways that settings are made differ among DAWs. When using a DAW, consult its operation manual.

Windows Media Player

Windows 10

1. Quit all applications, right-click the Start button menu and open the Control Panel.
2. Open "Sound".

NOTE

If you do not see this item, click Hardware and Sound.



3. On the Playback page, right-click "Speakers TASCAM US-20x20", and click "Set as Default Device" in the pop-up menu that appears. When you do this, the green check mark (✓) appears next to "Speakers TASCAM US-20x20".

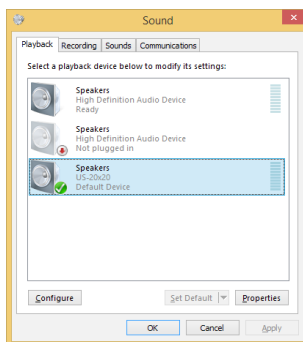

NOTE

To use this unit as the recording device, open the "Recording" page and use "Set as Default Device" for "Line In TASCAM US-20x20".

4. After completing the setting, click the OK button.
5. Start Windows Media Player, select an audio file and begin playback.

NOTE

- *If you change the setting while Windows Media Player is running, the software will not recognize that the device has been changed. In this case, restart Windows Media Player.*
- *If you still cannot hear sound after making the settings and completing the procedures above, restart the computer.*
- *If you make this setting, sound will be output through this unit, but no sound will be output by the computer's speakers or headphone jack.*

Windows 8.1

1. Click the button  that appears at the bottom left of the Start screen to open the Apps screen.
2. Click Control Panel.
3. Click "Hardware and Sound", and then open the "Sound" window.
4. On the Playback page, right-click "Speakers TASCAM US-20x20"; and click "Set as Default Device" in the pop-up menu that appears. When you do this, the green check mark (✓) appears next to "Speakers TASCAM US-20x20".

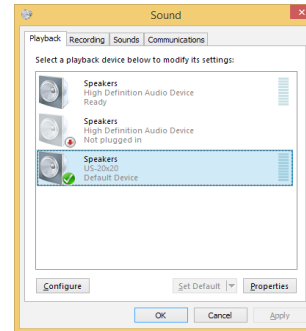

NOTE

To use this unit as the recording device, open the "Recording" page and use "Set as Default Device" for "Line In TASCAM US-20x20".

5. After completing the setting, click the OK button.
6. Launch Windows Media Player, select an audio file and start playback.

NOTE

- *If you change the setting while Windows Media Player is running, the software will not recognize that the device has been changed. In this case, restart Windows Media Player.*
- *If you still cannot hear sound after making the settings and completing the procedures above, restart the computer.*
- *If you make this setting, sound will be output through this unit, but no sound will be output from the computer's speakers or headphone jack.*

Windows 7

1. Quit all applications and open the Control Panel from the Start button menu.
2. Open "Sound".

NOTE

If you do not see this item, click Hardware and Sound.



3. On the Playback page, right-click "Speakers TASCAM US-20x20", and click "Set as Default Device" in the pop-up menu that appears.

When you do this, the green check mark (✓) appears next to "Speakers TASCAM US-20x20".

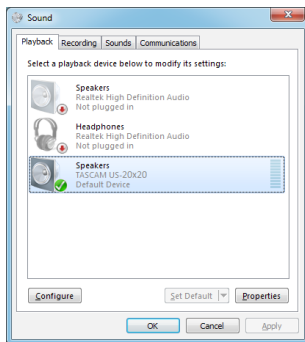

NOTE

To use this unit as the recording device, open the "Recording" page and use "Set as Default Device" for "Line In TASCAM US-20x20".

4. After completing the setting, click the OK button.
5. Start Windows Media Player, select an audio file and begin playback.

NOTE

- *If you change the setting while Windows Media Player is running, the software will not recognize that the device has been changed. In this case, restart Windows Media Player.*
- *If you still cannot hear sound after making the settings and completing the procedures above, restart the computer.*
- *If you make this setting, sound will be output through this unit, but no sound will be output by the computer's speakers or headphone jack.*

Mac OS X and iTunes

1. Open the Utilities folder in the Applications folder, and double-click "Audio MIDI Setup". Then open the "Audio Devices" window.
2. Click "US-20x20" to select it and right-click or control-click it. Then, click "Use this device for sound output" in the pop-up menu.

The speaker mark appears next to "US-20x20".

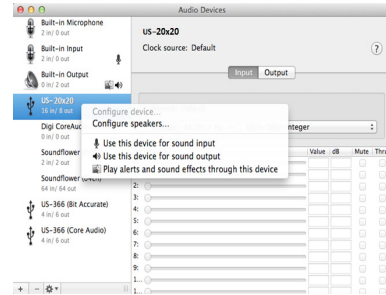

NOTE

To use this device as the recording device, select "Use this device for sound input" for the "US-20x20".

3. Launch iTunes, select an audio file and start playback.

NOTE

- *On a Mac, when setting the sampling rate to 176.4/192kHz, in "Audio MIDI" Setup set the input and output formats to "12ch-24bit Integer" before changing the DAW sampling frequency.*
- *Do not change the sampling frequency when YouTube, iTunes or another application is playing back.*

iOS

When using this unit with an iOS device, no special settings are necessary. You can use the unit immediately after connecting it to the device by USB.

NOTE

Connecting headphones or other equipment to the headphone jack of the iOS device will interrupt USB communication with the unit.

9 – MIDI Implementation Chart

■ MIDI Implementation Chart

Function		Transmit	Recognize	Remarks
Basic channels	When power on	×	×	Thru
	Settable	×	×	
Mode	When power on	×	×	Thru
	Messages	×	×	
	Altered		
Note number	Range	×	×	Thru
Velocity	Note on	×	×	Thru
	Note off	×	×	
Aftertouch	Polyphonic	×	×	Thru
	Channel	×	×	
Pitch bend		×	×	Thru
Control change		×	×	Thru
Program change		×	×	Thru
	Settable range		
System exclusive		×	×	Thru
System common	Position	×	×	Thru
	Song select	×	×	
	Tune	×	×	
System real-time	Clock	×	×	Thru
	Command	×	×	
Other	Local on/off	×	×	Thru
	All notes off	×	×	
	Active sense	×	×	
	Reset	×	×	
Notes				

Mode 1: OMNI ON, POLY
Mode 3: OMNI OFF, POLY

Mode 2: OMNI ON, MONO
Mode 4: OMNI OFF, MONO

○: YES
×: NO

10 – Troubleshooting

Please read this chapter if you are unable to use the unit properly even after setting it up following the procedures in this manual.

If you are still unable to resolve your problems please contact TASCAM customer support (see the end of this manual) with the following information about the operating environment and details about the trouble.

■ Operating environment

- Computer manufacturer
- Model
- CPU
- Memory (RAM)
- Operating system
- Applications used
- Antivirus software
- Wireless LAN use

See the end of this document for contact information.

■ The dedicated software cannot be installed

1. Check the operating system
The operating system you are using might not be supported by the software that you are trying to install.
Check the operating systems supported by the software that you are trying to install.
2. Stop software that is running in the background
Antivirus software and other software running in the background can interfere with installation. Quit software running in the background and try installing again.

■ The unit is connected, but the computer does not recognize it.

1. Install the dedicated software
 - If you have not done so, install the dedicated software. (See "Installing the dedicated software" on page 6.)
2. Change the USB port
 - This unit will not work with USB 1.1. Use a USB 3.0 or USB 2.0 port.
 - Do not use a USB hub. Always connect the unit directly to a USB port on the computer.
 - If the above steps do not resolve the problem, connect the unit to a different USB port on the computer.

■ There is no sound even when playing back on the computer.

The audio output must be set on the computer.

Please confirm the following while the unit is connected to the computer. Moreover, if you make the following settings, sound will be output through this unit, but no sound will be output by the computer's speakers or headphone jack.

Windows 10/Windows 8.1/Windows 7

See the "Windows Media Player" section in "8 – Application Guide" on page 30 of this manual, and make settings for the default playback device according to the OS.

Mac OS X

1. Quit all applications and open "System Preferences..." from the Apple menu.
2. Open "Sound".
3. On the Output tab, select "US-20x20".

After completing the setting, restart the computer and check the sound of playback. Depending on the application that you are using, you might need to make additional device settings.

In particular, DAW applications operate using audio engines with settings that are different from the OS settings, so confirm the DAW settings first after installing the driver and Settings Panel software for this unit.

Please see the manuals for the applications that you are using for detailed setting procedures.

10 – Troubleshooting

■ Sound breaks up or there is noise.

The processing load on the computer causes sound to break up and noise to occur.

Here are some methods to reduce the load on the computer.

1. A wireless LAN and software running in the background, including antivirus software, regularly put processing loads on the computer, which can cause sound to break up and other noise. Stop wireless LAN transmission, antivirus software and other software running in the background when using this unit.
2. Set the buffer size (latency) in the audio application that you are using or in this unit's Settings Panel to a larger value (Windows only).

NOTE

Consult the maker of the audio application that you are using for methods to reduce its load on your computer.

3. Change the settings of your computer so that they are optimal for audio processing.

Windows 10

1. Click the Start button and click "Explorer".
2. Right-click "PC" and select "Properties".
3. Click "Advanced system settings".
4. Click "Settings" in the "Performance" section of the "Advanced" tab of the "System Properties" window.
5. In the "Visual Effects" tab of the "Performance Options" window, select "Adjust for best performance".

Windows 8.1

1. Click the button  that appears at the bottom left of the Start screen to open the Apps screen.
2. Right-click "Computer" and select "Properties".
3. Click "Advanced system settings".
4. Click "Settings" in the "Performance" section of the "Advanced" tab of the "System Properties" window.
5. In the "Visual Effects" tab of the "Performance Options" window, select "Adjust for best performance".

Windows 7

a) Turn Aero off.

1. Right-click the desktop and select "Personalize".
2. Select a "Basic" or "High Contrast" theme.

b) Performance settings

1. Right-click "Computer" and select "Properties".
2. Click "Advanced system settings".
3. Click "Settings" in the "Performance" section of the "Advanced" tab of the "System Properties" window.
4. In the "Visual Effects" tab of the "Performance Options" window, select "Adjust for best performance".

Mac OS X

1. Open "System Preferences..." from the Apple menu, and select "Energy Saver".
2. Set "Computer sleep" to "Never".
3. Set "Display sleep" to "Never".

NOTE

Depending on the Mac OS X version and Mac computer model, this setting might not be available.

4. Change the USB port

Since the unit might not properly function with some USB ports, try connecting it to a different USB port.

NOTE

- *Try again after disconnecting other USB devices. (Keyboards and mice can be left connected.)*
- *Do not use a USB hub. Always connect the unit directly to a USB port on the computer (built-in)*
-

10 – Troubleshooting

- I am using SONAR and the performance with my TASCAM US-20x20 interface is not very good. How do I fix this?

First, make sure that your audio interface is set to ASIO mode:

- Press P to open the Preferences window
- Click “Playback and Recording” from the left column
- Set the Driver Mode to ASIO

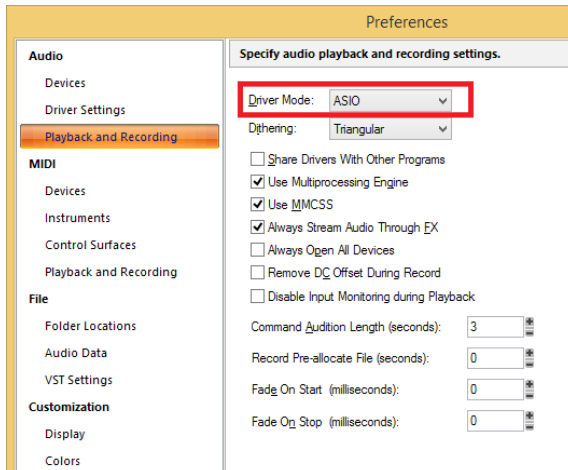

If you still have problems, change the Buffer Size in the US-20x20 Settings panel:

- Open the US-20x20 Settings panel
- Click the Interface tab
- Change the Buffer Size to a higher setting

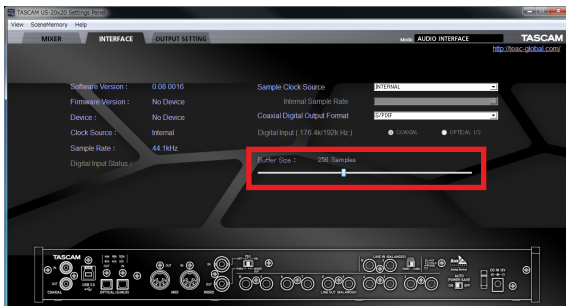

- I see that the US-20x20 recommends that I change the Windows Power Management settings. How do I do this?

Windows allows the processor to throttle to half speed when the computer is idle. However, this can affect the performance of DAW recording software. TASCAM recommends that this function be disabled, especially when using a multi-channel interface such as the US-20x20.

To Change the Power Management settings in Windows:

- Open the Control Panel.
- In Windows 10, right-click the Start button and click the Control Panel that appears.
- In Windows 8.1: Move the mouse pointer to the bottom right corner of the screen. When the Charms appear, click “Settings” and then click “Control Panel”.
- In Windows 7 and earlier this is in your Start menu
- Open the Power Options control panel by double-clicking it
- Click “Show Additional Plans”
- Click on “High Performance” in the Power Options

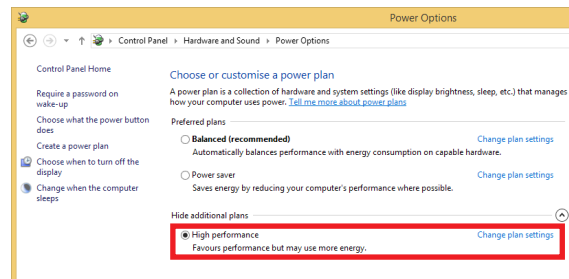

11 – Specifications

Ratings

■ Sampling frequencies

44.1, 48, 88.2, 96, 176.4, 192 kHz

■ Quantization bit depth

16/24-bit

Input/output ratings

Analog inputs

■ Mic inputs (balanced, IN1–IN8)

Connector: XLR-3-31 equivalent (1: GND, 2: HOT, 3: COLD)

Input impedance: 2.4 k Ω

Nominal input level (gain knob at MAX): –68 dBu (0.0003 Vrms)

Nominal input level (gain knob at MIN): –12 dBu (0.195 Vrms)

Maximum input level: +8 dBu (1.947 Vrms)

Gain range: 56 dB

■ Instrument inputs (unbalanced, IN1–IN2)

Connectors: 6.3mm (1/4") standard TS jacks (Tip: HOT, Sleeve: GND)

Input impedance: 1 M Ω or more

Nominal input level (gain knob at MAX): –68 dBV (0.0004 Vrms)

Nominal input level (gain knob at MIN): –12 dBV (0.251 Vrms)

Maximum input level: +8 dBV (2.512 Vrms)

Gain range: 56 dB

■ Line inputs (balanced, IN3–IN8)

Connectors: 6.3mm (1/4") standard TRS jacks (Tip: HOT, Ring: COLD, Sleeve: GND)

Input impedance: 10 k Ω

Nominal input level (gain knob at MAX): –52 dBu (0.0019 Vrms)

Nominal input level (gain knob at MIN): +4 dBu (1.228 Vrms)

Maximum input level: +24 dBu (12.282 Vrms)

Gain range: 56 dB

■ Line inputs (unbalanced, LINE IN 9–10)

When **LEVEL** switch set to **–10dBV**

Connectors: 6.3mm (1/4") standard TS jacks (Tip: HOT, Sleeve: GND)

Input impedance: 10 k Ω

Nominal input level: –10 dBV (0.3162 Vrms)

Maximum input level: +10 dBV (3.162 Vrms)

■ Line inputs (balanced, LINE IN 9–10)

When **LEVEL** switch set to +4dBu

Connectors: 6.3mm (1/4") standard TRS jacks (Tip: HOT, Ring: COLD, Sleeve: GND)

Input impedance: 10 k Ω

Nominal input level: +4 dBu (1.228 Vrms)

Maximum input level: +24 dBu (12.282 Vrms)

Analog outputs

■ Line outputs (balanced, LINE OUT 1–10)

Connectors: 6.3mm (1/4") standard TRS jacks

(Tip: HOT, Ring: COLD, Sleeve: GND)

Output impedance: 100 Ω

Nominal output level: +4 dBu (1.228 Vrms)

Maximum output level: +24 dBu (12.277 Vrms)

■ Headphone outputs (PHONES 1/2)

Connectors: 6.3mm (1/4") standard stereo jacks

Maximum output: 70mW + 70mW (THD+N 0.1% or less, into 32 Ω load)

Frequency response (input \rightarrow PHONES 1/2 output)

At 44.1 kHz and 48 kHz

20 Hz – 20 kHz: ± 1.0 dB (JEITA)

At 176.4 kHz and 192 kHz

20 Hz – 80 kHz: ± 5.0 dB (JEITA)

Digital audio input/output ratings

■ COAXIAL IN

Connectors: RCA pin jacks

Signal format: IEC60958-3 (S/PDIF)

Input impedance: 75 Ω

Input level: 0.5 Vp–p/75 Ω

■ COAXIAL OUT

Connectors: RCA pin jacks

Signal formats: IEC 60958-3 (S/PDIF)/IEC 60958-4 (AES/EBU)

- Changeable on the Settings Panel INTERFACE page

Output impedance: 75 Ω

Output level: 0.5 Vp–p/75 Ω

■ OPTICAL (S/MUX) IN/OUT

Connectors: OPTICAL (JEITA RC-5720C)

Signal format: Multi-channel optical (supports S/MUX when 88.2/96/176.4/192kHz)

Control input/output ratings

■ USB

Connector: USB 3.0 B type

Transfer rate: USB 3.0 Super Speed (5 Gbps)

■ MIDI IN connector

Connector: 5-pin DIN

Format: standard MIDI

■ MIDI OUT connector

Connector: 5-pin DIN

Format: standard MIDI

■ WORD IN connector

Connector: BNC

Input voltage: 2.0 Vp-p – 5.0 Vp-p

Input impedance: 75 Ω ±10%

Permitted frequency deviation during external synchronization: ±100 ppm

Terminal on/off switch

■ WORD OUT connector

Connector: BNC

Input voltage: 2.0 Vp-p (into 75 Ω)

Output impedance: 75 Ω ±10%

Sampling frequencies: 44.1, 48, 88.2, 96, 176.4 and 192 kHz
OUT/THRU switch

Audio performance

■ Mic amp EIN (equivalent input noise)

–125 dBu or lower

■ Frequency response

Input → LINE OUT (BALANCED)

At 44.1/48 kHz and 20 Hz – 20 kHz: ±0.5 dB (JEITA)

At 176.4/192 kHz and 20 Hz – 80 kHz: ±5 dB (JEITA)

■ S/N ratio

104 dB or higher (MIC/LINE IN → LINE OUT, gain knob at MIN, JEITA)

■ Distortion

0.005% or less (MIC/LINE IN → LINE OUT, 1kHz sine wave, at nominal input level and maximum output level)

■ Crosstalk

100 dB or more (MIC/LINE IN → LINE OUT, 1 kHz)

Computer system requirements

Check the TEAC Global Site (<http://teac-global.com/>) for the latest information about supported operating systems.

Windows

■ Supported operating systems

Windows 10 32-bit

Windows 10 64-bit

Windows 8.1 32-bit

Windows 8.1 64-bit

Windows 7 32-bit SP1 or later

Windows 7 64-bit SP1 or later

■ Computer hardware requirements

Windows computer with a USB 3.0 or USB 2.0 port

■ CPU/processor speed

2 GHz or faster dual core processor (x86)

■ Memory

2 GB or more

■ Display resolution

1280×800 or greater

CAUTION

- *The included USB cable (USB 2.0 or USB 3.0) and the USB specification that can be used depends on the computer and OS you are using.*

Supported operating systems	USB standard		USB cable connected
	USB 2.0	USB 3.0	
Windows 10 32-bit	✓	✓*	USB 3.0 cable*
Windows 10 64-bit	✓	✓*	
Windows 8.1 32-bit	✓	-	USB 2.0 cable
Windows 8.1 64-bit	✓	-	
Windows 7 32-bit SP1 or later	✓	-	USB 2.0 cable
Windows 7 64-bit SP1 or later	✓	-	

* Connect with the included USB 3.0 cable to use the USB 3.0 standard.

- *Operation of this unit was confirmed using standard computers that meet the above requirements. This does not guarantee operation with all computers that meet the above requirements. Even computers that meet the same system requirements might have processing capabilities that differ according to their settings and other operating conditions*

11 – Specifications

Mac OS X

■ Supported operating systems

OS X El Capitan (10.11.2 or later)
OS X Yosemite (10.10.1 or later)
OS X Mavericks (10.9.5)
OS X Mountain Lion (10.8.5)

■ Computer hardware requirements

Mac with a USB 3.0 or USB 2.0 port

■ CPU/processor speed

2 GHz or faster dual core processor

■ Memory

2 GB or more

■ Display resolution

1280×800 or greater

CAUTION

The included USB cable (USB 2.0 or USB 3.0) and the USB specification that can be used depends on the computer and OS you are using.

Supported operating systems	USB standard		USB cable connected
	USB 2.0	USB 3.0	
OS X El Capitan (10.11.2 or later)	✓	✓*	USB 3.0 cable* USB 2.0 cable
OS X Yosemite (10.10.1 or later)	✓	-	USB 2.0 cable
OS X Mavericks (10.9.5)	✓	-	USB 2.0 cable
OS X Mountain Lion (10.8.5)	✓	-	USB 2.0 cable

* Connect with the included USB 3.0 cable to use the USB 3.0 standard.

General

■ Power

DC12V AC adapter (GPE248-120200-Z)

■ Power consumption

20W

■ Dimensions

With standard frame attached

445 × 59 × 222 mm (W × H × D)

With rack mount adapters attached

482.6 × 44 × 222.4 mm (W × H × D)

■ Weight

2.7kg

■ Operating temperature range

5–35 °C (32–104 °F)

iOS devices

Device made by Apple Inc. running iOS 7 or later

Supported audio drivers

■ Windows

USB Audio Class 2.0, ASIO 2.0, WDM (MME), MIDI

■ Mac

Core Audio, Core MIDI

Dimensional drawings

- With standard frame attached (as shipped from the factory)

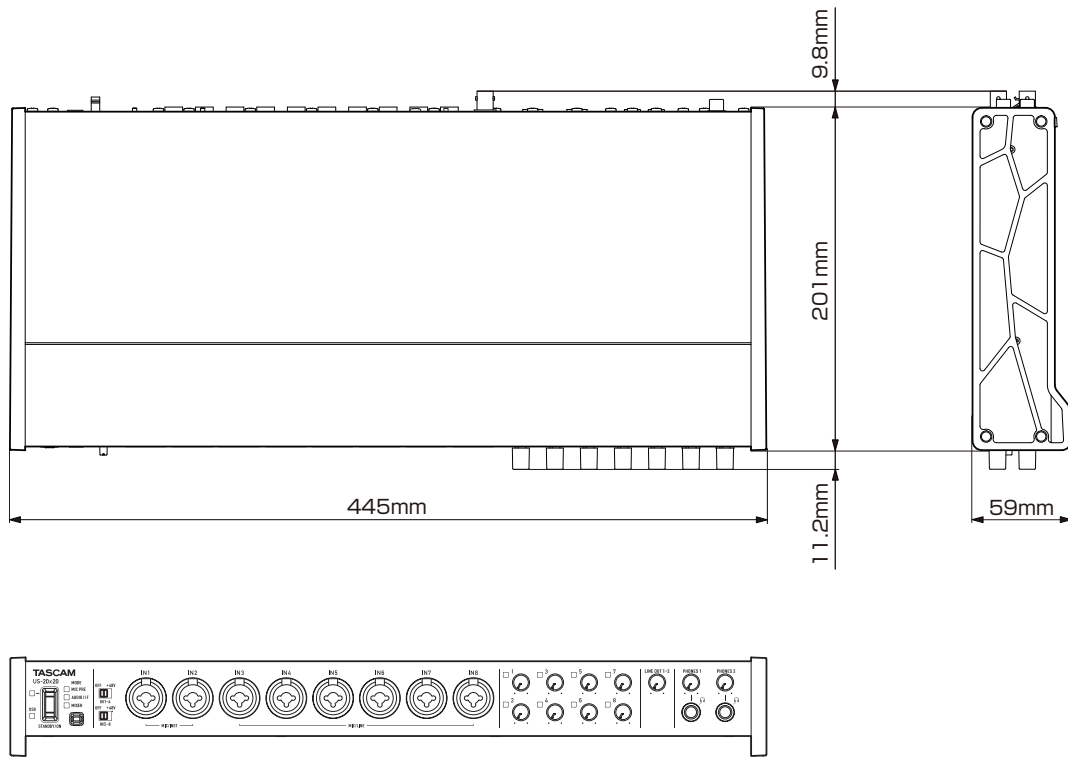

- With rack mount adapters attached

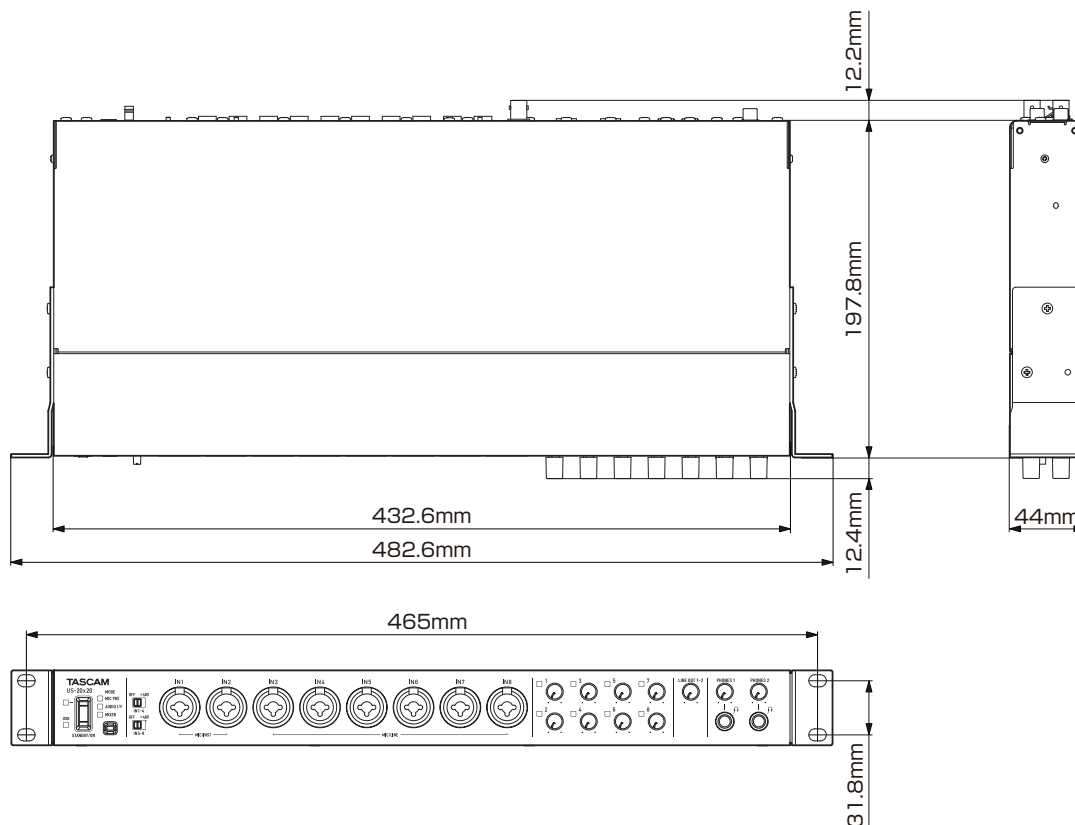

- Illustrations in this reference manual might differ in part from the actual product.
- The external appearance might be changed without notification to improve the product.

11 – Specifications

Block diagrams

Mic preamp mode

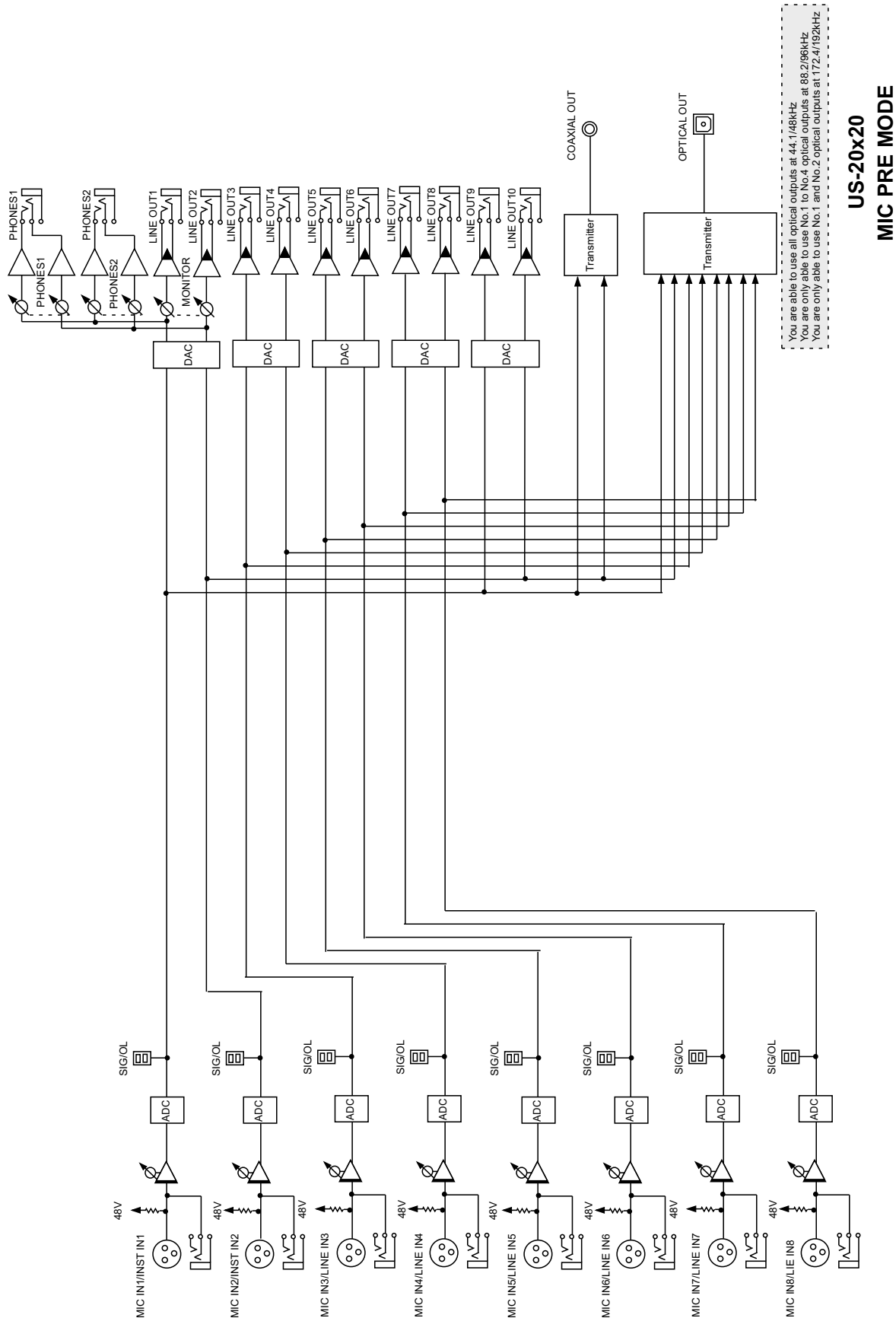

Audio interface mode

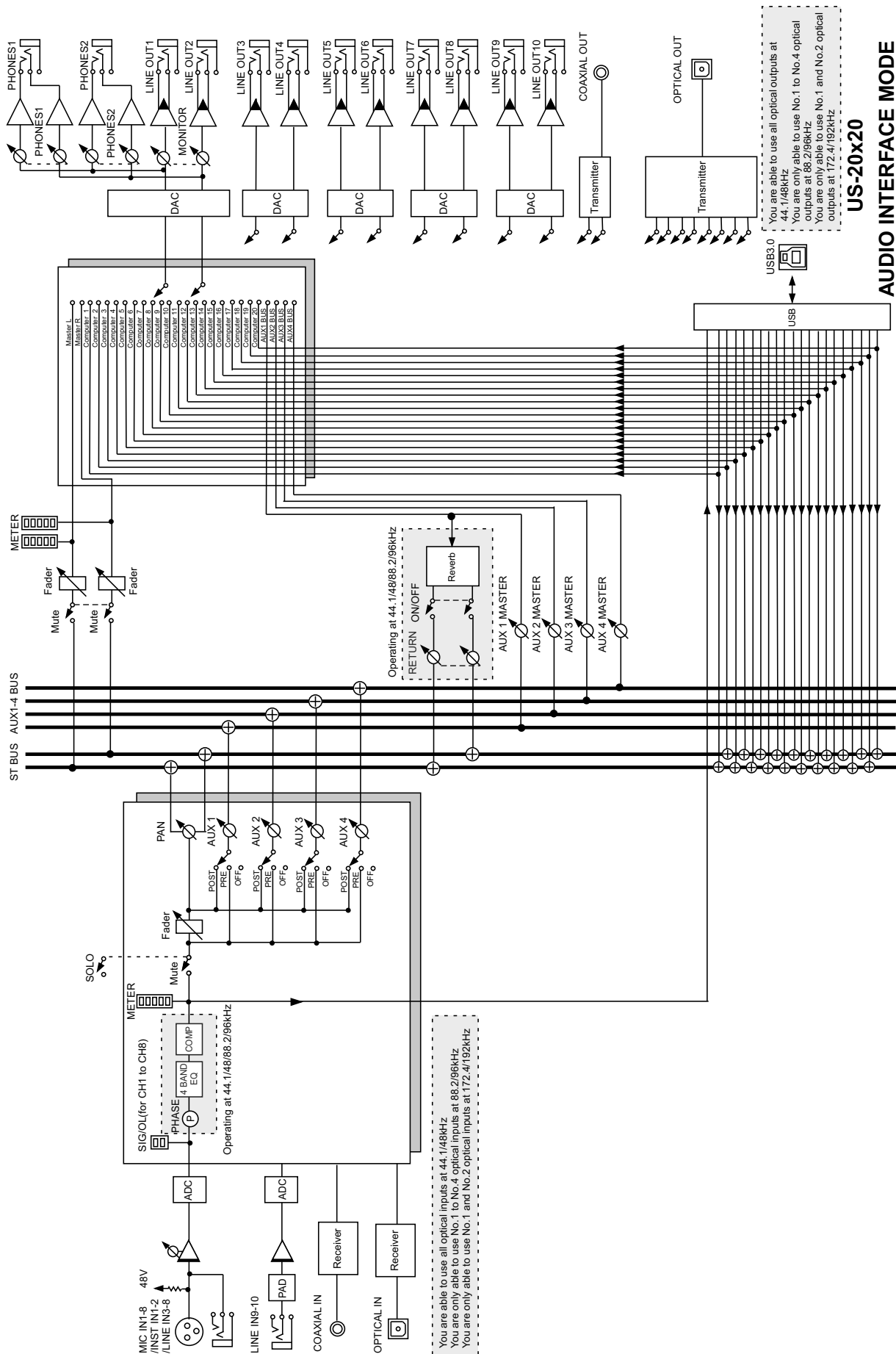

US-20x20 AUDIO INTERFACE MODE

11 - Specifications

Digital mixer mode

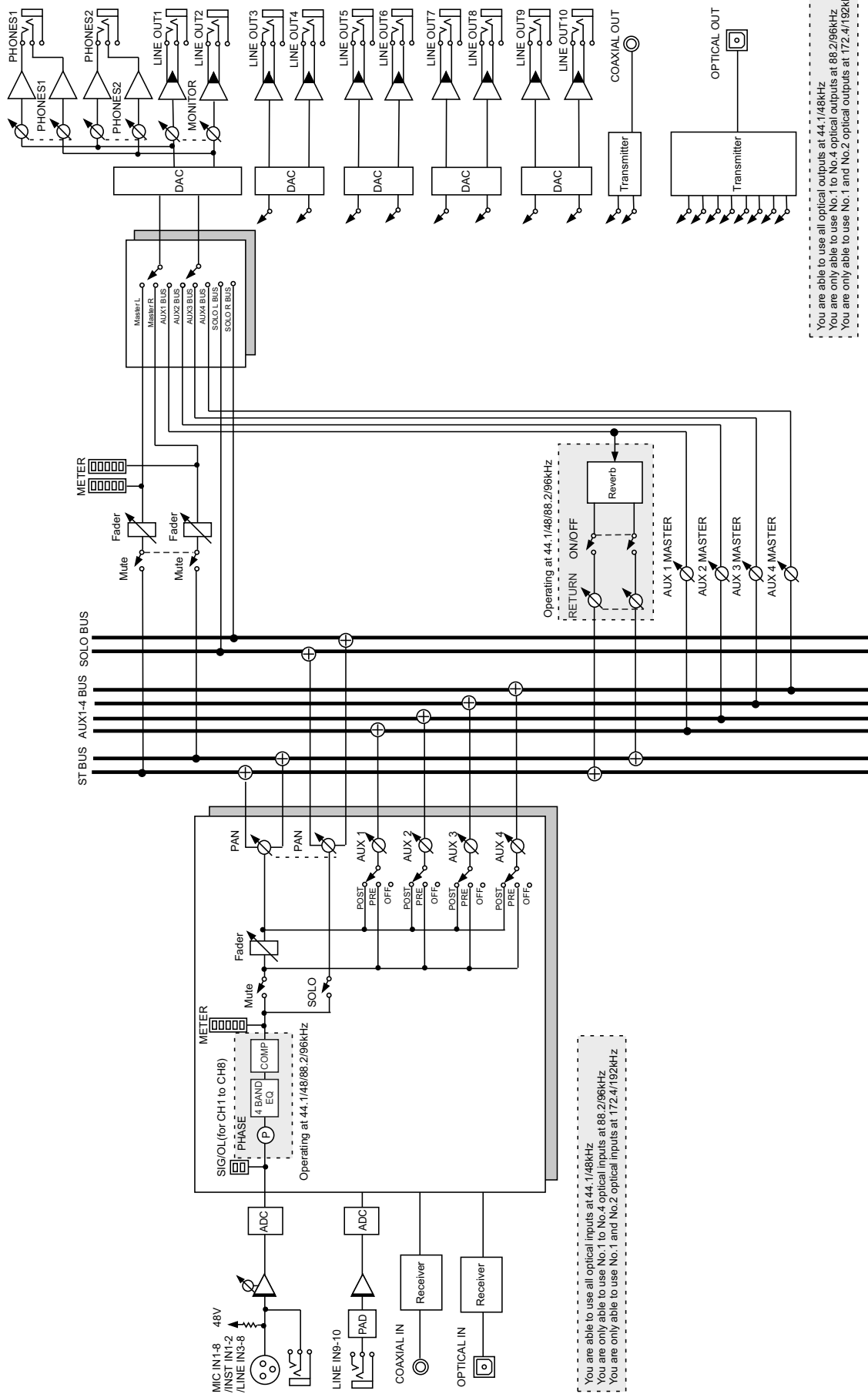

US-20x20
DIGITAL MIXER MODE

Level diagrams

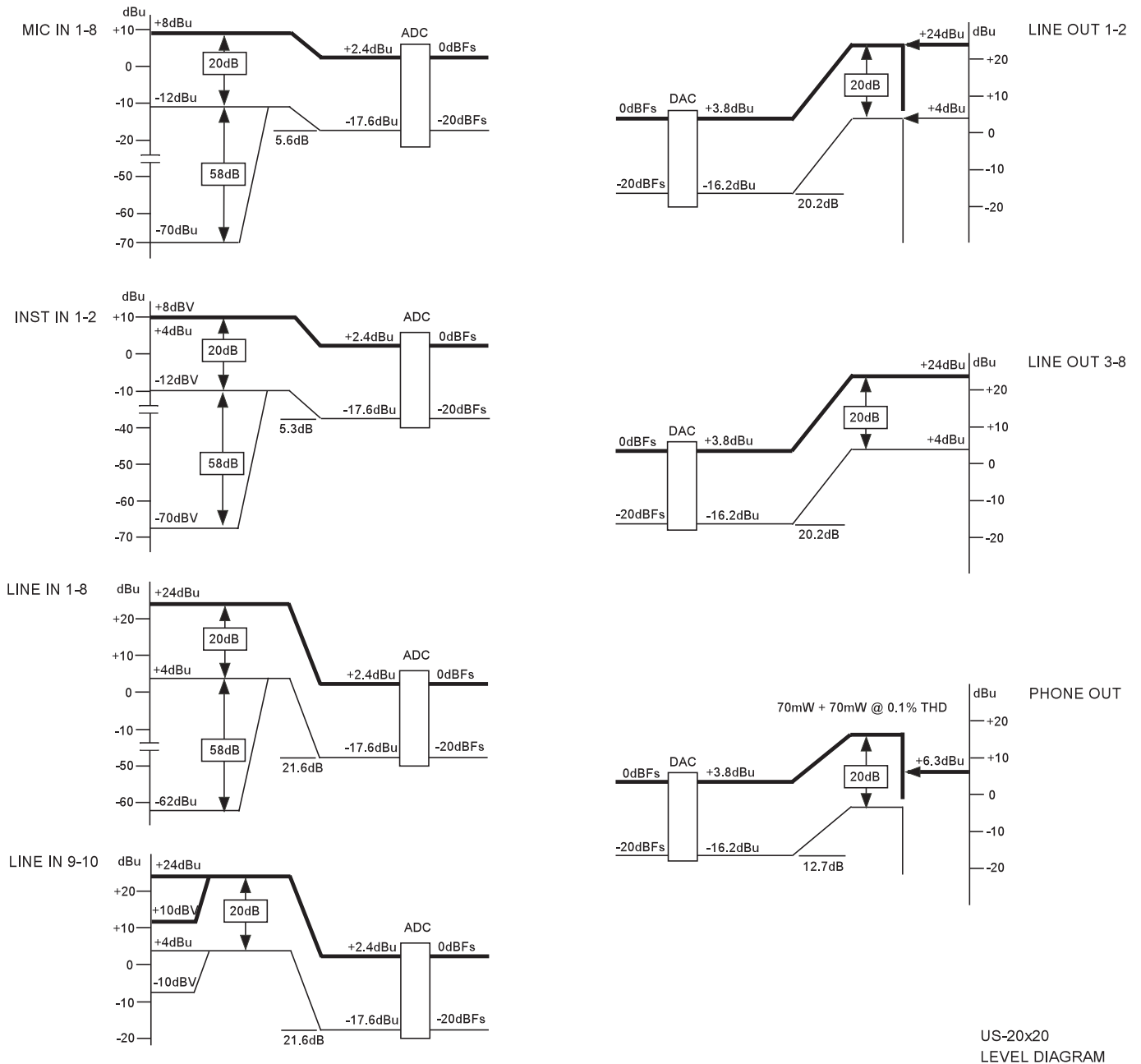

TASCAM

TEAC CORPORATION

Phone: +81-42-356-9143

1-47 Ochiai, Tama-shi, Tokyo 206-8530 Japan

<https://tascam.jp/jp/>

TEAC AMERICA, INC.

Phone: +1-323-726-0303

1834 Gage Road, Montebello, California 90640 USA

<http://tascam.com/>

TEAC MEXICO, S.A. de C.V.

Phone: +52-55-5010-6000

Río Churubusco 364, Colonia Del Carmen, Delegación Coyoacán, CP 04100, México DF, México

<http://teacmexico.net/>

TEAC UK Ltd.

Phone: +44-8451-302511

2 Huxley Road, Surrey Research Park, Guildford, GU2 7RE, United Kingdom

<http://tascam.eu/>

TEAC EUROPE GmbH

Phone: +49-611-71580

Bahnstrasse 12, 65205 Wiesbaden-Erbenheim, Germany

<http://tascam.eu/>

TEAC SALES & TRADING(SHENZHEN) CO., LTD

Phone: +86-755-88311561~2

Room 817, Block A, Hailrun Complex, 6021 Shennan Blvd., Futian District, Shenzhen 518040, China

<http://tascam.cn/>
